





## COMPANY PROFILE

KAI SUH SUH ENTERPRISE was established in 1969, in the enterprising spirit of "PROFESSIONALISM, QUALITY, SERVICE" serving 40,000 accounts in 128 countries across the world. KSS is No.1 cable ties and wiring accessories manufacturer in Taiwan, Asia and ranked as Top 3 in the world.

KSS privately owned industry park with an impressive floor area of 500,000 square meters, adopting state-of-the-art plastic injection, extrusion, tool and molding machine from Europe and Japan has enabled KSS to produce 50,000,000 pcs of cable ties & related accessories in a day.

KSS installed automatic warehouse integrated with ERP system that facilitates fast delivery to global customers efficiently. The warehouse has its capacity of 1,000 containers loaded inside.

KSS is an ISO 9001, ISO 14001, ISO 45001, IATF 1649 & ISO/IEC 17025 certificated company and KSS products have been approved by UL, CSA, VDE, DNV.GL, LR, CE, UKCA, ABS, IP68, RoHS, etc.

KSS has been awarded the "TOP 100 TAIWAN BRANDS", "THE NATIONAL BRAND YUSHAN AWARD" and "TAIWAN EXCELLENCE" for its high quality and innovation of products.

KSS always has one product for your needs or we are going to make one for you.

YEAR ESTABLISHED: 1969

EMPLOYEE : 600

PLANT SIZE: 500,000 M<sup>2</sup> (UTILIZED)

**Made in Taiwan**

**The leading brand of wiring accessories**



# Professional | Quality | Service



**TAIWAN EXCELLENCE**  
2015  
Cable Tie With Decoration Tag



**TAIWAN EXCELLENCE**  
2016  
Tire Rescue Tie



**TAIWAN EXCELLENCE**  
2017  
Luggage Tie



**TAIWAN EXCELLENCE**  
2019  
Releasable Cable Tie



**TAIWAN EXCELLENCE**  
2020  
Modular Cable Holder



**TAIWAN EXCELLENCE**  
2021  
Double Loop Mounting Tie



**TAIWAN EXCELLENCE**  
2022  
Two Way Cable Tie



**TAIWAN EXCELLENCE**  
2023  
Easy Releasable Cable Tie

KSS Private Industrial Park  
500,000 M<sup>2</sup>  
23 buildings





# COMPANY HISTORY



## 2006

Latest ISO 9001 quality management system certificated.



172,000M<sup>2</sup> private industry park completed. Build 2nd automatic warehouse with storage capacity up to 1000 x 20 feet container.

## 2004

ISO 14001 Environmental management system certificated.



## 2001

Build automatic warehouse with ERP system.

## 1996

Taipei office complex completed. (2000M<sup>2</sup>)

ISO 9002 quality management system certificated.

## 1988

KSS 2nd factory buliding started.

## 1969

KSS was established in Taipei.

# 2023

2021

Awarded "2020 Taiwan Excellence"- Double Loop Mounting Tie.

2020

Awarded "2020 Taiwan Excellence"- Modular Cable Clip.

2017

KSS 2nd private industry park 500,000M<sup>2</sup> completed.

2014

IATF 16949 the requirements of a quality management system for organizations in the automotive industry certificated.



國家品牌玉山獎  
THE NATIONAL BRAND YUSHAN AWARD

2013

Awarded three performances of "Enterprise with outstanding performance", "The Best Product" and "Contribution with Excellence" from "THE NATIONAL BRAND YUSHAN AWARD"

2011

Awarded "Top 100 Taiwan Brand".

TOP 100  
TAIWAN BRANDS



TAIWAN  
EXCELLENCE  
2023

Awarded "2023 Taiwan Excellence"- Two Way Releasable Cable Tie



Awarded "2022 Taiwan Excellence"- Two Way Cable Tie



Master the global market trends  
Professional manufacturer of wiring  
accessories



# KSS BUYERS INTERNATIONAL SALES NETWORK

- 
- 1 ALGERIA
  - 2 ARGENTINA
  - 3 ARMENIA
  - 4 AUSTRALIA
  - 5 AUSTRIA
  - 6 AZERBAIJAN
  - 7 BAHRAIN
  - 8 BANGLADESH
  - 9 BELARUS
  - 10 BELGIUM
  - 11 BELIZE
  - 12 BOLIVIA
  - 13 BOSNIA AND HERZEGOVINA
  - 14 BRAZIL
  - 15 BULGARIA
  - 16 CAMBODIA
  - 17 CANADA
  - 18 CHILE
  - 19 CHINA
  - 20 COLOMBIA
  - 21 COSTA RICA
  - 22 CROATIA
  - 23 CUBA
  - 24 CYPRUS
  - 25 CZECH
  - 26 DENMARK
  - 27 DOMINICAN REPUBLIC
  - 28 ECUADOR
  - 29 EGYPT
  - 30 EL SALVADOR
  - 31 ESTONIA
  - 32 FIJI
  - 33 FINLAND
  - 34 FRANCE
  - 35 GEORGIA
  - 36 GERMANY
  - 37 GHANA
  - 38 GREECE
  - 39 GUATEMALA
  - 40 GUINEA
  - 41 GUYANA
  - 42 HAITI
  - 43 HAWAII
  - 44 HONDURAS
  - 45 HONG KONG
  - 46 HUNGARY
  - 47 ICELAND
  - 48 INDIA
  - 49 INDONESIA
  - 50 IRAN
  - 51 IRAQ
  - 52 IRELAND
  - 53 ISRAEL
  - 54 ITALY
  - 55 IVORY COAST
  - 56 JAMAICA
  - 57 JAPAN
  - 58 JORDAN
  - 59 KAZAKHSTAN
  - 60 KENYA
  - 61 KOREA
  - 62 KOSOVO
  - 63 KUWAIT
  - 64 LATVIA
  - 65 LEBANON
  - 66 LITHUANIA
  - 67 MACAU
  - 68 MADAGASCAR
  - 69 MALAWI
  - 70 MALAYSIA
  - 71 MALDIVES
  - 72 MALTA
  - 73 MAURITIUS
  - 74 MEXICO
  - 75 MOLDOVA
  - 76 MONGOLIA
  - 77 MOROCCO
  - 78 MOZAMBIQUE
  - 79 NEPAL
  - 80 NETH ANTILLES
  - 81 NETHERLANDS
  - 82 NEW CALEDONIA
  - 83 NEW GUINEA
  - 84 NEW ZEALAND
  - 85 NIGERIA
  - 86 NORWAY
  - 87 OMAN
  - 88 PAKISTAN
  - 89 PANAMA
  - 90 PARAGUAY
  - 91 PERU
  - 92 PHILIPPINES
  - 93 POLAND
  - 94 PORTUGAL
  - 95 PUERTO RICO
  - 96 QATAR
  - 97 REPUBLIC OF MACEDONIA
  - 98 REPUBLIC OF SRPSKA
  - 99 ROMANIA
  - 100 RUSSIA
  - 101 SAUDI ARABIA
  - 102 SERBIA
  - 103 SINGAPORE
  - 104 SLOVAKIA
  - 105 SLOVENIA
  - 106 SOUTH AFRICA
  - 107 SPAIN
  - 108 SRI LANKA
  - 109 SUDAN
  - 110 SURINAME
  - 111 SWEDEN
  - 112 SWITZERLAND
  - 113 SYRIA
  - 114 TAIWAN
  - 115 THAILAND
  - 116 TRINIDAD
  - 117 TUNISIA
  - 118 TURKEY
  - 119 U.A.E.
  - 120 U.K.
  - 121 U.S.A.
  - 122 UKRAINE
  - 123 URUGUAY
  - 124 VANUATU
  - 125 VENEZUELA
  - 126 VIETNAM
  - 127 YEMEN
  - 128 ZIMBABWE



## KSS COMPANY ORGANIZATION

INTERNATIONAL DEPARTMENT

HEAD OFFICE

TAICHUNG BRANCH OFFICE

TAINAN FACTORY

TAINAN BRANCH OFFICE

TAINAN CENTRAL LOGISTICS

KAOHSIUNG BRANCH OFFICE

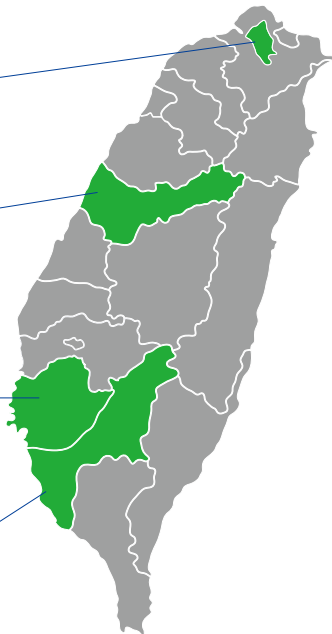

# WIRING DUCTS

0101 WIRING DUCT (SLOTTED) P.20	0101A WIRING DUCT CUTTER P.21	0101A WIRING DUCT CUTTER P.21	0101 WIRING DUCT (CLOSE SLOTTED) P.22	0101 WIRING DUCT ASSEMBLE TOOL P.22	0101 WIRING DUCT (SLOTTED) P.23
0101 WIRING DUCT (SLOTTED) P.23	0101 WIRING DUCT (SLOTTED) P.24	0102 HALOGEN FREE WIRING DUCT P.24	0101 WIRING DUCT (SLOTTED) P.25	0104 FLEXIBLE WIRING DUCT P.25	0105 WIRING DUCT (SOLID) P.26
0101 NON-SLIP WIRING DUCT COVER P.26	0105 WIRING DUCT CONNECTOR P.27	0105 MINI TRUNKING P.27	0105 WIRING DUCT P.28	0105 WIRING DUCT P.28	0105 WIRING DUCT P.28
0105 WIRING DUCT CONNECTOR P.29	0105 WIRING DUCT CONNECTOR P.29	0105 WIRING DUCT CONNECTOR P.29	0105 WIRING DUCT CONNECTOR P.29	0105 WIRING DUCT CONNECTOR P.29	0105 WIRING DUCT CONNECTOR P.29
0105 WIRING DUCT COUPLER P.30	0106 WIRE RETAINER P.30	0106 WIRE SADDLE P.31	0107 MULTI-COMPARTMENT WIRING DUCT P.31	0108 WIRING DUCT CONNECTOR P.32	0112 DECORATION WIRING DUCT CONNECTOR P.32
0110 DECORATION WIRING DUCT P.33	0113 ONE PIECE WIRING DUCT P.34	0113 ONE PIECE WIRING DUCT P.34	0113 ONE PIECE WIRING DUCT P.34	0113 ONE PIECE WIRING DUCT CONNECTOR P.35	0114 ELECTRICAL BOX P.35
0115 TELEPHONE WIRING DUCT P.36	0116 TELEPHONE WIRING DUCT CONNECTOR P.37	0116 TELEPHONE WIRING DUCT CONNECTOR P.37	0118 TELEPHONE WIRING DUCT (SELF-ADHESIVE) P.38	0118 TELEPHONE WIRING DUCT CONNECTOR P.38	0119 ADHESIVE TAPE P.38
0119 DOUBLE-COATED FOAM TAPE P.38	0120 U TYPE WIRING DUCT P.39	0121 ROUND INSULATING CONDUIT P.39	0122 OVAL INSULATING CONDUIT P.39	0124 WIRING DUCT P.40	0124 CABLE CLIP P.40
0125 ROUND TYPE WIRING DUCT P.41	0125 ROUND TYPE WIRING DUCT CONNECTOR P.41	0125 ROUND TYPE WIRING DUCT CONNECTOR P.41	0126 ROUND TYPE WIRING DUCT P.42	0130 SOFT SPLIT-INSERT WIRING DUCT P.42	0127 ROUND TYPE WIRING DUCT WITH ALUMINUM COVER P.43
0131 COVERING DUCT P.43	0128 SOFT WIRING DUCT P.44	0132 MODULAR CABLE HOLDER P.45	0133 ONE PIECE WIRING DUCT P.46	0133 ONE PIECE WIRING DUCT CONNECTOR P.46	0140 MOSAIC TRUNKING P.46
0140 MOSAIC TRUNKING CONNECTOR P.46					



## CABLE MARKERS

 P.49	 P.49	 P.50	 P.50	 P.50	 P.50
0201 EC TYPE CABLE MARKER	0201 ECP TYPE CABLE MARKER	0201 COLOR CODED CABLE MARKER	0202 COLOR CODED CABLE MARKER	0201A MARKER BOX	0202 FLAT CABLE MARKER
 P.51	 P.51	 P.52	 P.52	 P.52	 P.53
0203 MARKER STRIP	0205 O TYPE CABLE MARKER	0207 O TYPE MARKER TUBE	0207 O TYPE MARKER TUBE	0207 O TYPE MARKER TUBE	0208 FLAT MARKER TUBE
 P.54	 P.54	 P.55	 P.55	 P.56	 P.56
0210 MARKER PLATE	0212 MARKER BOX	0215 SELF ADHESIVE WIRE MARKER	0215 SELF ADHESIVE WIRE MARKER	0225 OC TYPE CABLE MARKER	0234 MB TYPE CABLE MARKER
 P.57	 P.57	 P.57	 P.58	 P.58	 P.58
0235 U TYPE CABLE MARKER	0236 SM TYPE CABLE MARKER	0236 SM TYPE CABLE MARKER	0236 SM TYPE COLOR CODED CABLE MARKER	0236 SM TYPE COLOR CODED CABLE MARKER	0236 SM TYPE COLOR CODED CABLE MARKER

## CABLE TIES

 P.64	 P.66	 P.66	 P.67	 P.67	 P.68
0301 NYLON CABLE TIE	0301 SUPER STRENGTH NYLON CABLE TIE	0301 HVAC NYLON CABLE TIE	0301 METAL DETECTABLE CABLE TIE	0301 EXTRA HIGH TEMPERATURE CABLE TIE	0301 HEAT STABILIZED CABLE TIE
 P.68	 P.69	 P.69	 P.70	 P.70	 P.71
0301 NYLON 612 CABLE TIE	0301 FLAME RETARDANT CABLE TIE	0301 POLYPROPYLENE CABLE TIE	0301 COLD WEATHER CABLE TIE	0301 EXTRA HEAVY DUTY TIE	0301 UV RESISTANT SUPER STRENGTH NYLON CABLE TIE
 P.71	 P.72	 P.74	 P.74	 P.75	 P.75
0302 TIE GUN	0301 UV RESISTANT NYLON CABLE TIE	0305 MOUNTING CABLE TIE	0309 DOUBLE LOOP MOUNTING TIE	0309 DOUBLE HEAD CABLE TIE (UNRELEASABLE)	0309 DOUBLE HEAD CABLE TIE (RELEASABLE)
 P.76	 P.76	 P.77	 P.77	 P.78	 P.78
0309 HANDCUFF TIE	0309 TWO WAY CABLE TIE	0309 TWO WAY RELEASABLE CABLE TIE	0310 BEAD TIE	0312 RELEASABLE MARKER TIE	0312 MARKER TIE
 P.79	 P.79	 P.80	 P.80	 P.80	 P.81
0313 SECURITY MARKER TIE	0313 SECURITY MARKER TIE	0314 MARKER TIE	0315 EASY RELEASABLE CABLE TIE	0315 EASY RELEASABLE CABLE TIE	0315 SNAP-LOCK RELEASABLE CABLE TIE
 P.81	 P.81	 P.82	 P.82	 P.83	 P.83
0315 SNAP-LOCK RELEASABLE CABLE TIE ACCESSORIES	0315 RELEASABLE CABLE TIE	0315 RELEASABLE CABLE TIE	0315 RELEASABLE CABLE TIE	0316 RELEASABLE CABLE TIE	0316 RELEASABLE LASHING CABLE TIE

## CABLE TIES



0318 PUSH MOUNT COLLECT TIE P.84



0319 SADDLE MOUNTING TIE P.84



0319 SADDLE MOUNTING TIE P.84



0320 DOUBLE LOCKING CABLE TIE P.85



0320 DOUBLE LOCKING CABLE TIE P.86



0320 DOUBLE LOCKING CABLE TIE P.86



0321 IN-LINE CABLE TIE P.87



0321 OUTSIDE SERRATED CABLE TIE P.87



0325 KNOT TIE (BEAD TYPE) P.87



0326 DOUBLE HEAD KNOT TIE P.88



0327 KNOT TIE P.88



0330 WIRE COLLECT TIE P.89



0332 WIRE COLLECT TIE P.89



0335 RELEASABLE PUSH MOUNT TIE P.89



0335 PUSH MOUNT TIE P.90



0340 CABLE TRAY FIXING TIE P.90



0342 CHASSIS TIE P.91



0343 MOUNTING ADJUSTABLE TIE P.91



0355 NYLON CABLE TIE WITH STOPPER P.91



0350 MAGIC CABLE TIE P.92

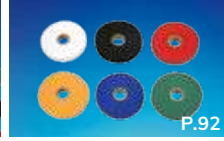

0350 MAGIC CABLE TIE P.92



0351 MAGIC TIES WITH PLASTIC BUCKLE P.92



0352 MAGIC TIES WITH METAL BUCKLE P.92



0361 COATED COPPER TUBE CABLE TIE P.93



0365 CABLE TIE WITH DECORATION TAG P.93



0365 CABLE TIE WITH 360 DEGREE ROTATION TAG P.94



0365 HOOK TIE P.94



0365 LUGGAGE TIE P.95



0370 STAINLESS STEEL CABLE TIE P.95



0372 LADDER TYPE STAINLESS STEEL TIE WITH FULLY COATING P.96



0373 RELEASABLE STAINLESS STEEL TIE WITH FULLY COATING P.96

## WRAPPING BAND



0401 SPIRAL WRAPPING BAND P.98



0401 SPIRAL WRAPPING BAND P.98



0401 SPIRAL WRAPPING BAND P.98



0401 SPIRAL WRAPPING BAND P.99



0402 DOUBLE LAYER SPIRAL WRAPPING BAND P.99



0402 SPLIT WRAPPING BAND P.100



0402 SPLIT WRAPPING BAND P.100



0402 SPLIT WRAPPING BAND INSTALLATION TOOL P.100

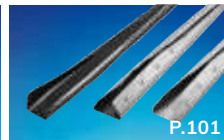

0403 WRAPPING BAND P.101



0403 WRAPPING BAND P.101



0405 BINDING BAND P.101



0410 BINDING BAND P.102



0420 TWIST TIE P.102



0425 SNAP BAND P.102

## CABLE CLAMPS & TIE MOUNTS

 P.104	 P.104	 P.104	 P.105	 P.105	 P.106
0501 CABLE CLAMP	0502 ADJUSTABLE CABLE CLAMP	0503 CABLE CLAMP	0505 SELF ADHESIVE TIE MOUNT	0510 SADDLE TYPE TIE MOUNT	0511 WALL PLUG MOUNT
 P.106	 P.107	 P.107	 P.108	 P.108	 P.109
0511 WALL PLUG	0511 CABLE HOLDER	0512 PUSH TIE MOUNT	0513 TWIN TIE DEVICE	0514 LADDER TYPE CABLE HOLDER	0515 SELF-ADHESIVE CABLE CLAMP
 P.109	 P.109	 P.110	 P.110	 P.110	 P.111
0516 PUSH TIE MOUNT	0517 ADJUSTABLE CABLE CLAMP	0518 CABLE CLAMP	0519 ADJUSTABLE CABLE CLAMP	0521 MOUNTING WIRE CLIP	0520 SELF-ADHESIVE WIRE CLIP
 P.111	 P.112	 P.112	 P.112	 P.113	 P.113
0520 SELF-ADHESIVE WIRE CLIP	0522 WIRE CLIP	0524 WIRE CLIP	0525 CATV SIDING CLIP	0526 SELF-ADHESIVE WIRE CLIP	0526 SELF-ADHESIVE WIRE CLIP
 P.113	 P.114	 P.114	 P.114	 P.115	 P.115
0526 MULTIPLE WIRE CLIP	0527 CABLE CLAMP	0528 CABLE CLAMP	0529 SELF-ADHESIVE WIRE CLIP	0530 FLAT CABLE CLAMP	0531 CABLE CLAMP
 P.115	 P.116	 P.116	 P.117	 P.117	 P.117
0532 CABLE CLAMP	0535 FLAT CABLE CLAMP	0538 CABLE STACKER	0539 CABLE CLAMP	0540 CABLE CLAMP	0545 SELF-ADHESIVE WIRE CLIP
 P.118	 P.118	 P.118			
0550 PAPER ROLL CLIP	0555 SNAP CLAMP	0558 PIPE CLIP			

## GLANDS, BUSHINGS

 P.122	 P.123	 P.124	 P.125	 P.126	 P.127
0604 METRIC THREAD NYLON CABLE GLAND	0604 METRIC THREAD NYLON CABLE GLAND	0606 PG THREAD NYLON CABLE GLAND	0606 PG THREAD NYLON CABLE GLAND	0604 PF THREAD NYLON CABLE GLAND	0608 NPT THREAD NYLON CABLE GLAND
 P.127	 P.128	 P.128	 P.129	 P.130	 P.131
0609 NPT THREAD RIGHT ANGLE NYLON CABLE GLAND	0607 GLAND ADAPTOR	0607 ENLARGER GLAND	0607 REDUCTION GLAND	0603 NYLON CABLE GLAND (WITH STRAIN RELIEF)	0605 BUSHING GLAND
 P.131	 P.132	 P.134	 P.136	 P.138	 P.140
0610 MICRO SWITCH COVER	0613 MULTI-HOLE NYLON CABLE GLAND (2 HOLES)	0613 MULTI-HOLE NYLON CABLE GLAND (3 HOLES)	0613 MULTI-HOLE NYLON CABLE GLAND (4 HOLES)	0613 MULTI-HOLE NYLON CABLE GLAND (5 HOLES)	0613 MULTI-HOLE NYLON CABLE GLAND (6 HOLES)

## GLANDS, BUSHINGS



## CONDUITS



## BUSHINGS



## BUSHINGS



0735 SCREW PLUG

## WIRE CONNECTORS



0801 CLOSE-END WIRE CONNECTOR



0804 WIRE NUT DRIVE



0808 SCREW ON WIRE CONNECTOR



0809 SCREW ON WIRE CONNECTOR



0810 MID-WAY WIRE CONNECTOR

## TUBES



0901 VINYL WIRE END CAP



0906 VINYL TUBE



0905 VINYL WIRE END MARKER CAP



0907 END CAP



0908 HEXAGONAL PROTECTION CAP



0908 SCREW PROTECTION CAP



0909 SCREW PROTECTION CAP



0910 ALLIGATOR CLIP



0915 TUBE OF ALLIGATOR CLIP



0920 HEAT SHRINKING SLEEVE



0933 HOT MELT ADHESIVE TUBE



0933 OVAL HOT MELT ADHESIVE TUBE



0931 PVC TUBE



0927 HEAT-SHRINKABLE TUBE (WK32)



0927 HALOGEN FREE HEAT-SHRINKING TUBINGS (NHR2)



0927 HALOGEN FREE HEAT-SHRINKING TUBINGS (NHR4)



0927 HEAT-SHRINKABLE TUBINGS



0927 HEAT-SHRINKABLE TUBINGS



0927 HEAT-SHRINKABLE TUBINGS



0927 HEAT-SHRINKABLE TUBINGS WITH INNER GLUE (SCM)



0927 HEAT-SHRINKABLE TUBINGS WITH INNER GLUE (W3F2)



0927 HEAT-SHRINKABLE TUBINGS WITH INNER GLUE (SSA3)



0927 HEAT-SHRINKABLE TUBINGS

## CABLE CLIPS



1001 NAIL CABLE CLIP



1001 NAIL CABLE CLIP



1005 NAIL CABLE CLIP



1010 NAIL CABLE CLIP



1011 NAIL CABLE CLIP



1010 NAIL CABLE CLIP



1011 NAIL CABLE CLIP



1019 NAIL CABLE CLIP



1020 NAIL CABLE CLIP



1020 NAIL CABLE CLIP



1020 NAIL CABLE CLIP



1018 NAIL CABLE CLIP



1012 DOUBLE NAIL CABLE CLIP



1012 DOUBLE NAIL CABLE CLIP



1023 COATED COPPER TUBE CLIP



1030 PIN PLUG

## PCB PARTS

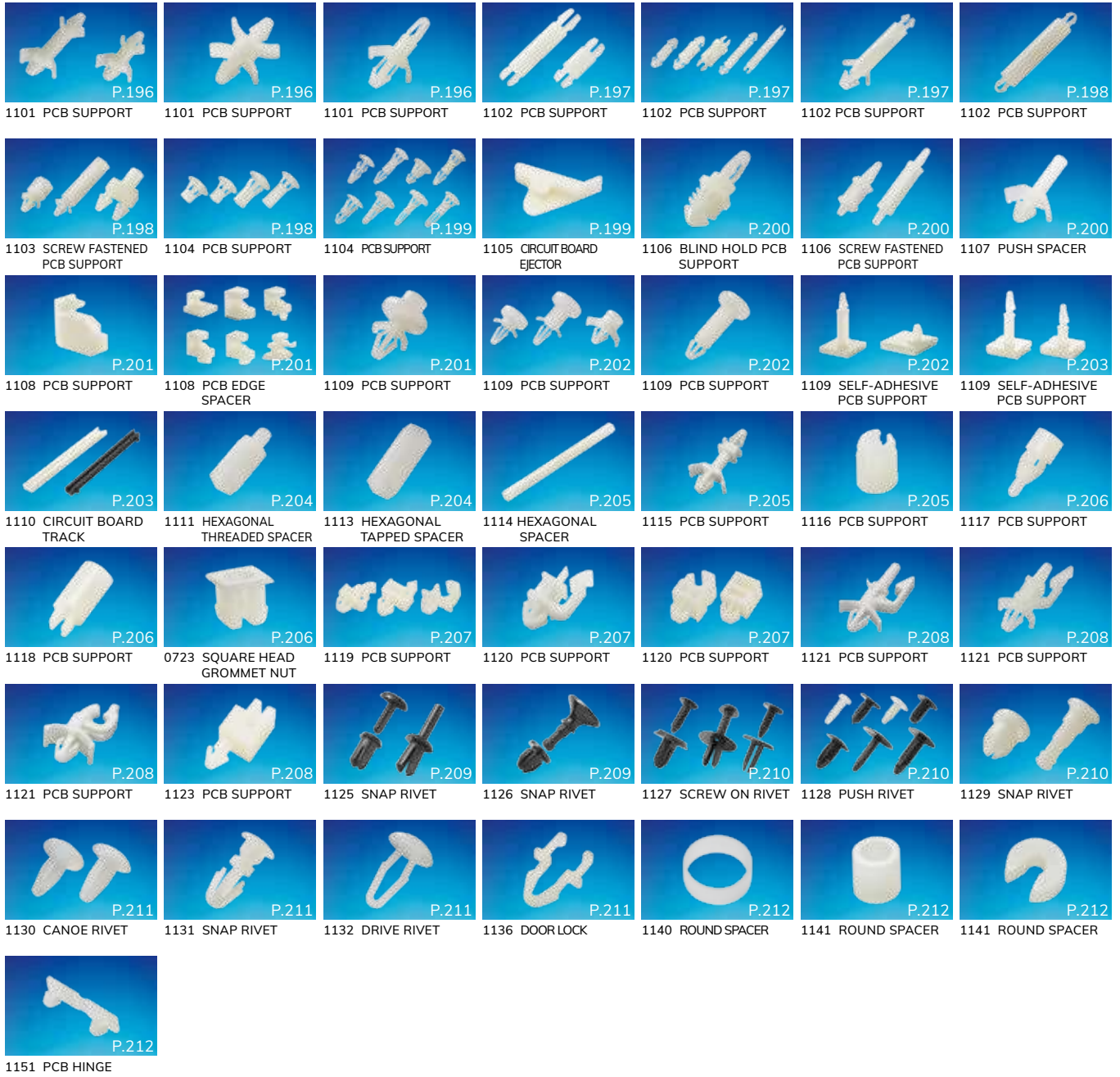

## FASTENERS

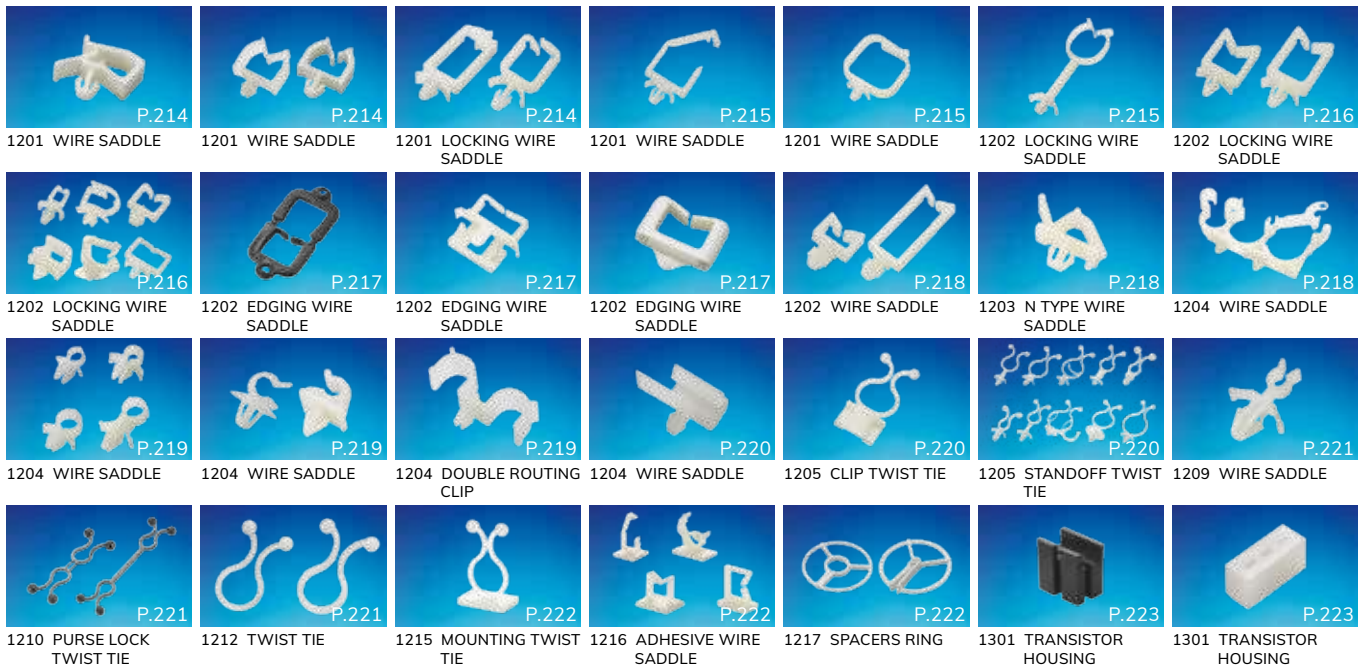

## FASTENERS

 P.223	 P.223	 P.224	 P.224	 P.224	 P.224	 P.225
1302 TRANSISTOR HOUSING	1302 NTC THERMISTOR HOUSING	1303 TRANSISTOR HOUSING	1305 WASHER	1306 WASHER	1307 HEADBOARD WASHER	1308 ROUND WASHER
 P.225	 P.225	 P.226	 P.226	 P.226	 P.227	 P.227
1308 CONOID WASHER	1310 TRANSISTOR WASHER	1311 TRANSISTOR WASHER	1321 LED HOLDER	1322 LED HOLDER	1327 LED HOLDER	1328 LED HOLDER
 P.227	 P.227	 P.228	 P.228	 P.228	 P.229	 P.229
1329 LED HOLDER	1331 LED HOLDER	1332 LED HOLDER	1333 LED HOLDER	1334 LED HOLDER	1335 LED HOLDER	1336 LED HOLDER
 P.229	 P.230	 P.230	 P.230	 P.231	 P.231	 P.231
1337 LED HOLDER	1338 LED HOLDER	1339 LED HOLDER	1341 LED HOLDER	1343 LED HOLDER	1344 LED HOLDER	1345 LED HOLDER
 P.232	 P.232	 P.232	 P.232	 P.233	 P.233	 P.233
1346 LED HOLDER	1347 LED HOLDER	1349 LED HOLDER	1351 CAPACITOR HOUSING	1401 PLASTIC SCREWS	1401 PLASTIC SCREWS	1401 PLASTIC SCREWS
 P.234	 P.234	 P.234	 P.234			
2001 RJ45 MODULAR PLUG	2001 PLUG COVER	2002 DUST COVER FOR RJ45 PLUG	2005 U CONNECTOR			

## VALUE PACK

 P.236	 P.236	 P.236	 P.237	 P.237	 P.237	 P.237
 P.238	 P.238	 P.238	 P.238	 P.239	 P.239	 P.239
 P.239	 P.239	 P.239	 P.239	 P.239	 P.240	 P.240
 P.240	 P.240	 P.240	 P.240	 P.241	 P.241	 P.241
 P.242	 P.242	 P.242	 P.243	 P.243	 P.243	 P.244
 P.244	 P.244	 P.244	 P.244	 P.245	 P.245	 P.245
 P.245	 P.246	 P.246	 P.246			

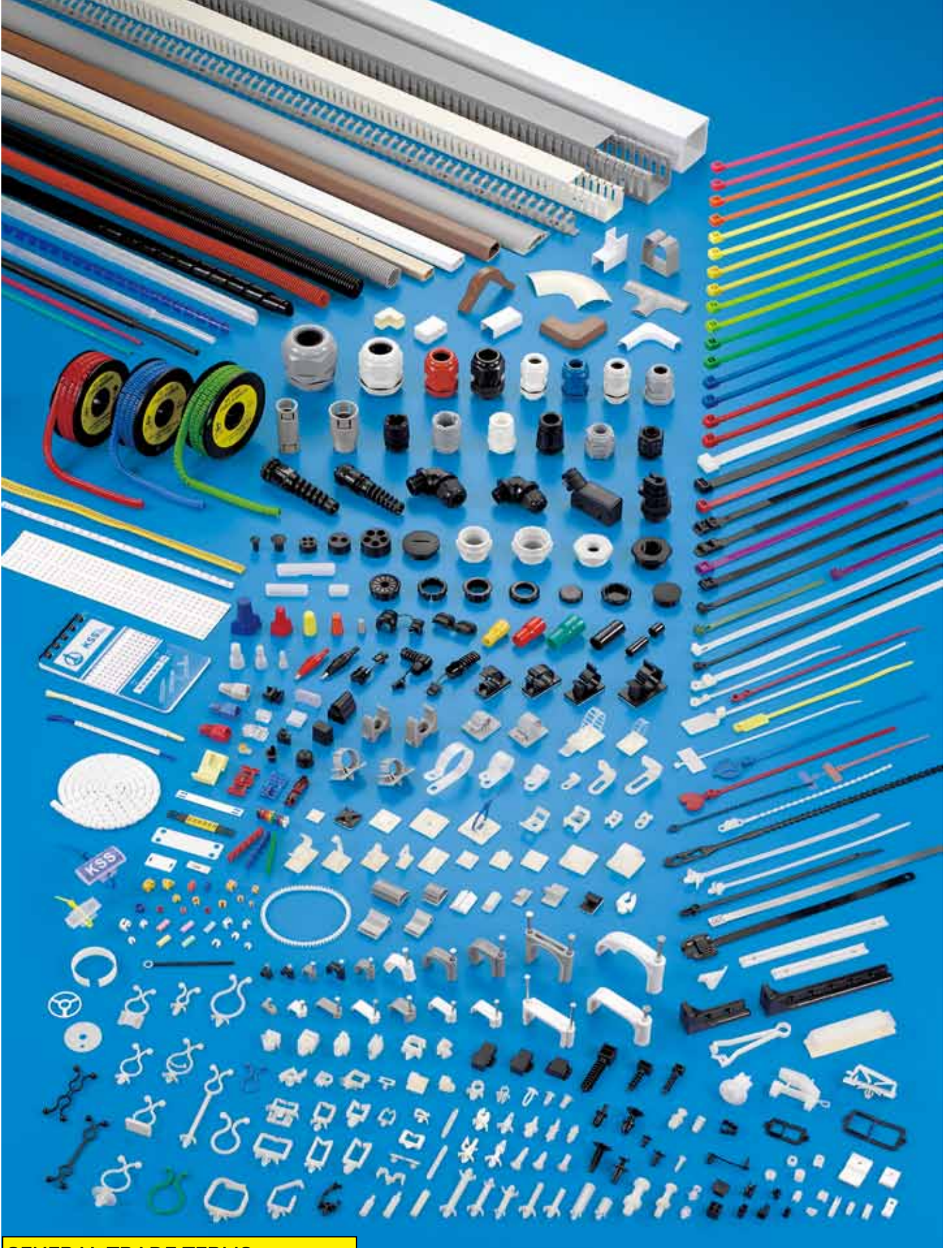
**GENERAL TRADE TERMS :**

OUR PRODUCTS ARE WARRANTED TO BE FREE FROM DEFECTS IN MATERIALS AT THE TIME OF SALE BUT OUR OBLIGATION UNDER THIS WARRANTY IS LIMITED TO THE REPLACEMENT OF ANY PRODUCT PROVED TO BE DEFECTIVE WITHIN 3 MONTHS FROM THE DATE OF DELIVERY AND CAN PROVE TO BE THE RESPONSIBILITY OF FACTORY.

NO FURTHER CLAIM, SUCH AS FREIGHT, TAX...ETC. WILL BE ACCEPTED.

BECAUSE OF THE VARIED NATURE OF THE USES OF THESE PRODUCTS EACH USER SHOULD MAKE THEIR OWN EVALUATIONS REGARDING THE SUITABILITY OF THESE PRODUCTS FOR THEIR SPECIFIC APPLICATION.

USER SHALL DETERMINE THE SUITABILITY OF THE PRODUCT FOR HIS INTENDED APPLICATION AND ASSUMES ALL RISKS & LIABILITY WHATSOEVER IN CONNECTION THEREWITH. NEITHER SELLER NOR MANUFACTURER SHALL BE LIABLE FOR ANY INJURY, LOSS, OR DAMAGE, WHETHER DIRECT OR CONSEQUENTIAL, ARISING OUT OF THE USE OF, OR THE INABILITY TO USE, THE PRODUCT.



# Wiring Ducts

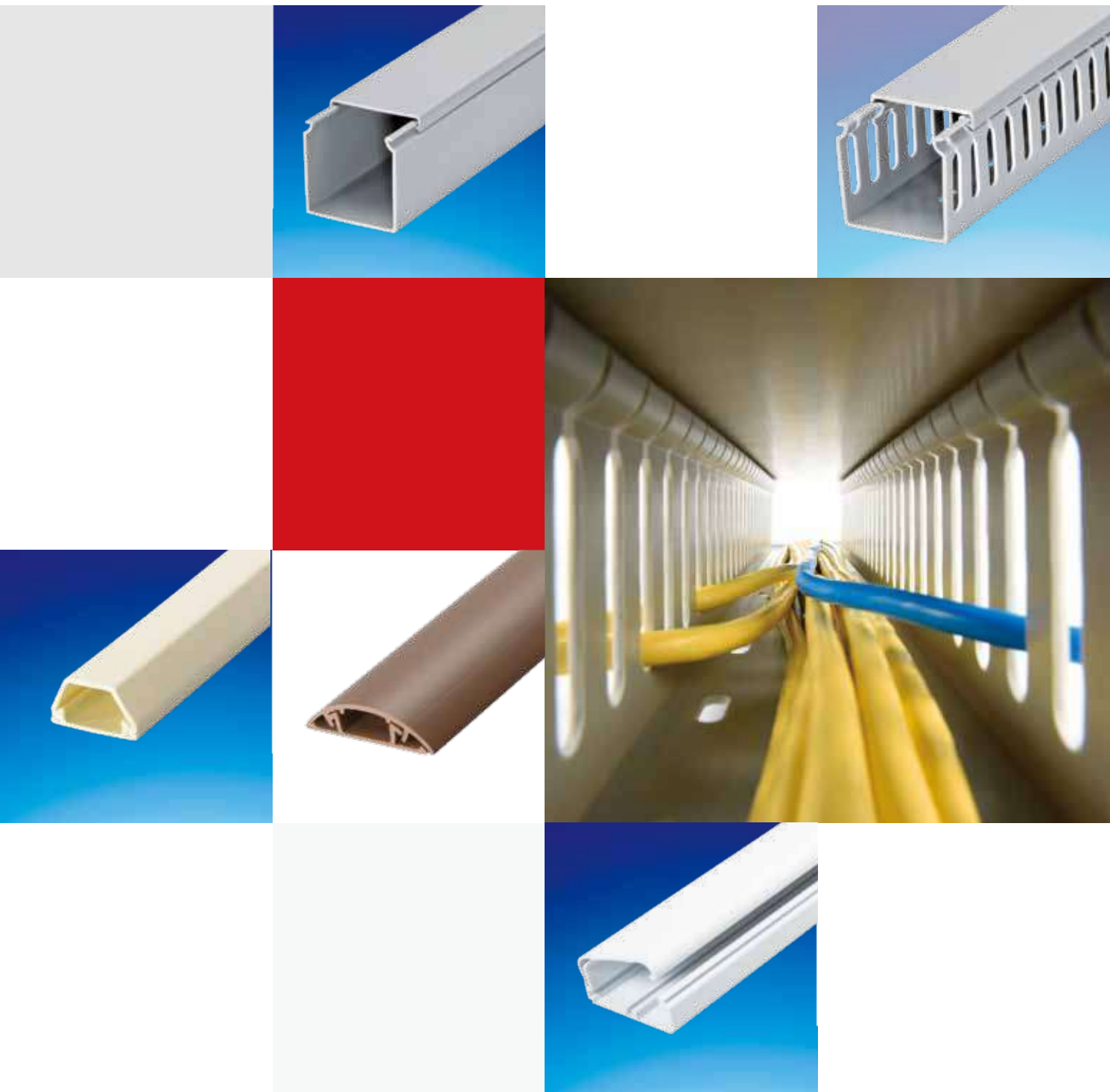

Wiring  
Ducts

Cable  
Markers

Cable  
Ties

Wrapping  
Bands

Cable Clamps  
& Tie Mounts

Glands,  
Bushings

Conduits

Bushings

Wire  
Connectors

Tubes

Cable  
Clips

PCB  
Parts

Fasteners



# Technical Data

## KSS Wiring Duct (Slotted) Wirefill Capacity

Duct Size		Wire Size	0.75mm <sup>2</sup>	1.25mm <sup>2</sup>	2mm <sup>2</sup>	3.5mm <sup>2</sup>	5.5mm <sup>2</sup>	8mm <sup>2</sup>	14mm <sup>2</sup>	22mm <sup>2</sup>	LAN cable	
W	H	O.D. mm	22-20AWG	22-16AWG	16-14AWG	12AWG	12-10AWG	8AWG	6AWG	4AWG	Cat. 5e	Cat. 6
15	25	Wirefill is based on 60% cross-sectional area	30	25	19	14	9	6	3	2	10	5
20	20		32	26	20	15	9	6	4	2	11	6
25	25		51	41	32	23	15	10	6	4	17	9
25	30		61	50	38	28	18	12	7	5	21	11
25	40		82	66	51	37	24	16	10	7	28	15
25	45		92	75	58	42	27	18	11	7	31	17
25	50		102	83	64	46	30	20	12	8	35	18
25	60		123	100	77	56	36	25	15	10	42	22
25	65		133	108	84	60	39	27	16	11	46	24
25	75		154	125	97	70	45	31	19	13	53	28
25	80		164	133	103	75	48	33	20	14	56	30
30	30		74	60	46	33	21	15	9	6	25	13
30	60		148	120	93	67	43	30	18	12	51	27
30	80		197	160	124	90	57	40	24	17	68	36
33	33		89	72	56	40	26	18	11	7	30	16
33	40		108	88	68	49	31	22	13	9	37	19
33	45		122	99	77	55	35	24	15	10	42	22
33	60		162	132	102	74	47	33	20	14	56	29
33	65		176	143	111	80	51	35	22	15	60	32
33	100		271	220	171	123	79	55	34	23	93	49
37.5	100		308	250	194	140	90	62	38	26	106	56
38	25		78	63	49	35	22	15	9	6	26	14
38	50		156	126	98	71	45	31	19	13	53	28
38	75		234	190	147	106	68	47	29	20	80	43
40	20		65	53	41	30	19	13	8	5	22	12
40	40		131	106	83	60	38	26	16	11	45	24
40	60		197	160	124	90	57	40	24	17	68	36
40	65		213	173	134	97	62	43	27	18	73	39
40	80	263	213	166	120	76	53	33	22	90	48	
40	100	329	266	207	150	96	66	41	28	113	60	
45	45	166	135	105	75	48	33	21	14	57	30	
45	65	240	195	151	109	70	48	30	20	82	44	
48	60	237	192	149	108	69	48	29	20	81	43	
48	100	395	320	249	180	115	80	49	34	136	72	
50	50	205	166	129	93	60	41	25	17	70	37	
50	75	308	250	194	140	90	62	38	26	106	56	

# Technical Data

## KSS Wiring Duct (Slotted) Wirefill Capacity

Duct Size		Wire Size	0.75mm <sup>2</sup>	1.25mm <sup>2</sup>	2mm <sup>2</sup>	3.5mm <sup>2</sup>	5.5mm <sup>2</sup>	8mm <sup>2</sup>	14mm <sup>2</sup>	22mm <sup>2</sup>	LAN cable	
W	H		22-20AWG	22-16AWG	16-14AWG	12AWG	12-10AWG	8AWG	6AWG	4AWG	Cat. 5e	Cat. 6
		O.D. mm	2.7	3.0	3.4	4.0	5.0	6.0	7.6	9.2	4.6	6.3
55	100	Wirefill is based on 60% cross-sectional area	452	366	285	206	132	91	57	38	155	83
60	40		197	160	124	90	57	40	24	17	68	36
60	60		296	240	186	135	86	60	37	25	102	54
60	80		395	320	249	180	115	80	49	34	136	72
60	100		493	400	311	225	144	100	62	42	170	90
65	45		240	195	151	109	70	48	30	20	82	44
65	65		347	281	219	158	101	70	43	29	119	63
70	40		230	186	145	105	67	46	29	19	79	42
70	100		576	466	363	262	168	116	72	49	198	105
72	64		379	307	239	172	110	76	47	32	130	69
75	40		246	200	155	112	72	50	31	21	85	45
75	50		308	250	194	140	90	62	38	26	106	56
75	75		462	375	291	210	135	93	58	39	159	85
75	100		617	500	389	281	180	125	77	53	212	113
80	40		263	213	166	120	76	53	33	22	90	48
80	60		395	320	249	180	115	80	49	34	136	72
80	80		526	426	332	240	153	106	66	45	181	96
80	100		658	533	415	300	192	133	83	56	226	120
100	40		329	266	207	150	96	66	41	28	113	60
100	50		411	333	259	187	120	83	51	35	141	75
100	60		493	400	311	225	144	100	62	42	170	90
100	75		617	500	389	281	180	125	77	53	212	113
100	80		658	533	415	300	192	133	83	56	226	120
100	100		823	666	519	375	240	166	103	70	283	151
120	60		592	480	373	270	172	120	74	51	204	108
120	65		641	520	404	292	187	130	81	55	221	117
120	75		740	600	467	337	216	150	93	63	255	136
120	80		790	640	498	360	230	160	99	68	272	145
150	75		925	750	583	421	270	187	116	79	318	170
150	100		1234	1000	778	562	360	250	155	106	425	226
200	100	1646	1333	1038	750	480	333	207	141	567	302	
200	150	2469	2000	1557	1125	720	500	311	212	850	453	
200	200	3292	2666	2076	1500	960	666	415	283	1134	604	
300	100	2469	2000	1557	1125	720	500	311	212	850	453	

Above chart data is calculated by formula, accurate wirefill capacity may be different.



# Technical Data

## KSS Wiring Duct (Solid) Wirefill Capacity

Duct Size		Wire Size	0.75mm <sup>2</sup>	1.25mm <sup>2</sup>	2mm <sup>2</sup>	3.5mm <sup>2</sup>	5.5mm <sup>2</sup>	8mm <sup>2</sup>	14mm <sup>2</sup>	22mm <sup>2</sup>	LAN cable	
W	H	O.D. mm	22-20AWG	22-16AWG	16-14AWG	12AWG	12-10AWG	8AWG	6AWG	4AWG	Cat. 5e	Cat. 6
			2.7	3.0	3.4	4.0	5.0	6.0	7.6	9.2	4.6	6.3
15	25	Wirefill is based on 50% cross-sectional area	25	20	16	11	7	5	3	2	8	4
16	16		17	14	11	8	5	3	2	1	6	3
20	20		27	22	17	12	8	5	3	2	9	5
25	16		27	22	17	12	8	5	3	2	9	5
25	25		42	34	27	19	12	8	5	3	14	7
33	33		74	60	47	34	21	15	9	6	25	13
33	40		90	73	57	41	26	18	11	7	31	16
33	45		101	82	64	46	29	20	12	8	35	18
38	16		41	33	26	19	12	8	5	3	14	7
38	25		65	52	41	29	19	13	8	5	22	11
40	20		54	44	34	25	16	11	6	4	18	10
40	40		109	88	69	50	32	22	13	9	37	20
40	60		164	133	103	75	48	33	20	14	56	30
40	80		219	177	138	100	64	44	27	18	75	40
45	45		138	112	87	63	40	28	17	11	47	25
45	65		200	162	126	91	58	40	25	17	69	36
50	25		85	69	54	39	25	17	10	7	29	15
50	50		171	138	108	78	50	34	21	14	59	31
50	75		257	208	162	117	75	52	32	22	88	47
60	40		164	133	103	75	48	33	20	14	56	30
60	60		246	200	155	112	72	50	31	21	85	45
60	80		329	266	207	150	96	66	41	28	113	60
65	45		200	162	126	91	58	40	25	17	69	36
65	65		289	234	182	132	84	58	36	24	99	53
75	40		205	166	129	93	60	41	25	17	70	37
75	50		257	208	162	117	75	52	32	22	88	47
75	75		385	312	243	175	112	78	48	33	132	70
80	40		219	177	138	100	64	44	27	18	75	40
80	60		329	266	207	150	96	66	41	28	113	60
80	80		438	355	276	200	128	88	55	37	151	80
80	100	548	444	346	250	160	111	69	47	189	100	
100	40	274	222	173	125	80	55	34	23	94	50	
100	50	342	277	216	156	100	69	43	29	118	62	
100	60	411	333	259	187	120	83	51	35	141	75	
100	75	514	416	324	234	150	104	64	44	177	94	
100	100	685	555	432	312	200	138	86	59	236	125	
150	60	617	500	389	281	180	125	77	53	212	113	
150	75	771	625	486	351	225	156	97	66	265	141	
150	100	1028	833	648	468	300	208	129	88	354	188	
200	100	1371	1111	865	625	400	277	173	118	472	251	
300	100	2057	1666	1297	937	600	416	259	177	708	377	
400	100	2743	2222	1730	1250	800	555	346	236	945	503	
500	100	3429	2777	2162	1562	1000	694	432	295	1181	629	
600	100	4115	3333	2595	1875	1200	833	519	354	1417	755	

Above chart data is calculated by formula, accurate wirefill capacity may be different.

# Technical Data

## Wirefill Capacity

Duct Size		O.D. mm	Wire Area (mm <sup>2</sup> )	Number of Wires (pcs)																		
				1	2	3	4	5	6	7	8	9	10	20	30	40	50	60	70	80	90	100
0.75mm <sup>2</sup>	22-20AWG	2.7	Wire Area (mm <sup>2</sup> )	7	15	22	29	36	44	51	58	66	73	146	219	292	365	437	510	583	656	729
1.25mm <sup>2</sup>	22-16AWG	3.0		9	18	27	36	45	54	63	72	81	90	180	270	360	450	540	630	720	810	900
2.0mm <sup>2</sup>	16-14AWG	3.4		12	23	35	46	58	69	81	92	104	116	231	347	462	578	694	809	925	1040	1156
3.5mm <sup>2</sup>	12AWG	4.0		16	32	48	64	80	96	112	128	144	160	320	480	640	800	960	1120	1280	1440	1600
5.5mm <sup>2</sup>	12-10AWG	5.0		25	50	75	100	125	150	175	200	225	250	500	750	1000	1250	1500	1750	2000	2250	2500
8.0mm <sup>2</sup>	8AWG	6.0		36	72	108	144	180	216	252	288	324	360	720	1080	1440	1800	2160	2520	2880	3240	3600
14.0mm <sup>2</sup>	6AWG	7.6		58	116	173	231	289	347	404	462	520	578	1155	1733	2310	2888	3466	4043	4621	5198	5776
22.0mm <sup>2</sup>	4AWG	9.2		85	169	254	339	423	508	592	677	762	846	1693	2539	3386	4232	5078	5925	6771	7618	8464
LAN cable	Cat. 5e	4.6		21	42	63	85	106	127	148	169	190	212	423	635	846	1058	1270	1481	1693	1904	2116
	Cat. 6	6.3		40	79	119	159	198	238	278	318	357	397	794	1191	1588	1985	2381	2778	3175	3572	3969

Above **wire area** data is calculated by the formula = (Wire O.D.)<sup>2</sup>  
Please calculate the **wire area** based on the actual wires used.

[Slotted Duct]

$$\text{Wire Fill Capacity} = (W \times H) \times 60\%$$

$$\text{Wire Fill Capacity} = \frac{(W \times H) \times 60\%}{(\text{Wire O.D.})^2}$$

[Solid Duct]

$$\text{Wire Fill Capacity} = (W \times H) \times 50\%$$

$$\text{Wire Fill Capacity} = \frac{(W \times H) \times 50\%}{(\text{Wire O.D.})^2}$$

Instruction to choose suitable duct size :

e.g. 12 (8.0mm<sup>2</sup>) + 34 (5.0mm<sup>2</sup>)

Use above chart to get wire area of each e.g. (360 + 72 + 750 + 100)

Add to calculate the total wire area e.g. **1282 mm<sup>2</sup>**

The duct you choose its fill capacity should be equal or larger than your necessary wire area

a.If choose 45x45 Solid wiring duct : 45 x 45 x 50% = 1012 mm<sup>2</sup> ≤ 1282 mm<sup>2</sup> → (NO) Cannot Fit

b.If choose 45x65 Solid wiring duct : 45 x 65 x 50% = 1462 mm<sup>2</sup> ≥ 1282 mm<sup>2</sup> → (YES) Can Fit

## KSS Non-Slip Wiring Duct Cover

Choose of glue contained non-slip duct cover prevent cover slippage during device transportation, tested according to ASTM D1894-14.

Wiring Ducts

Cable Markers

Cable Ties

Wrapping Bands

Cable Clamps & Tie Mounts

Glands, Bushings

Conduits

Bushings

Wire Connectors

Tubes

Cable Clips

PCB Parts

Fasteners

# 0101 KSS WIRING DUCT (SLOTTED)

Wiring Ducts

Cable Markers

Cable Ties

Wrapping Bands

Cable Clamps & Tie Mounts

Glands, Bushings

Conduits

Bushings

Wire Connectors

Tubes

Cable Clips

PCB Parts

Fasteners

- Material: **UL94V-0** and **M1** flame rated, UL approved PVC.
- Color: Grey.
- PVC service temperature: 85°C
- UL Test up to 50°C
- These devices are for routing of wires within devices in factory installations.
- Features parallel holes on both sidewalls to facilitate cutting in wire application.
- Special color, size, length upon request of reasonable quantity.
- ※ The standard wiring duct can be available for non-slip cover, suitable for vertical installations. The item number please specify for example,  
Item no. : MD-2→MQ-2, KD-5.5→KQ-5.5, HD-8→HQ-8  
Non-slip cover for the size less than 20mm width or bigger than 125mm is available upon request.
- ※ Item number with suffix-V for upper score line allows finger removal without tool during the installation when a greater opening is required. For example: MDV-2L



**HD** SLOT : 4mm

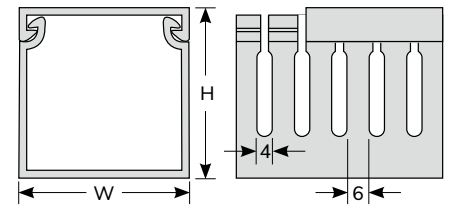

**KD** SLOT : 6mm

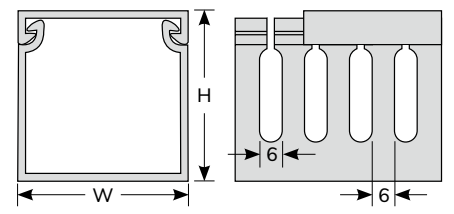

**MD** SLOT : 8mm

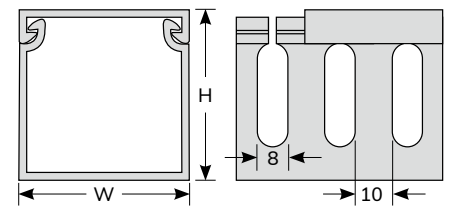

Item No.			W x H	Length
SLOT				
8mm	6mm	4mm	mm	
MD-0.5L		HD-0.5L	15 X 25	2M
MD-0.7L		HD-0.7L	20 X 20	
MD-0L		HD-0L	25 X 25	
MD-1L	KD-1L	HD-1L	25 X 45	
MD-1.1L		HD-1.1L	30 X 30	
MD-1.2L	KD-1.2L	HD-1.2L	33 X 33	
MD-1.5L	KD-1.5L	HD-1.5L	33 X 45	
MD-2L	KD-2L	HD-2L	45 X 45	
MD-2.2L		HD-2.2L	50 X 50	
MD-2.5L	KD-2.5L	HD-2.5L	65 X 45	
MD-3L	KD-3L	HD-3L	33 X 65	
MD-4L	KD-4L	HD-4L	25 X 65	
MD-5L	KD-5L	HD-5L	45 X 65	
MD-5.5L	KD-5.5L	HD-5.5L	60 X 60	
MD-5.7L	KD-5.7L	HD-5.7L	65 X 65	
MD-6L			72 X 64	
MD-6.5L		HD-6.5L	33 X 100	
MD-6.6L			37.5 X 100	
MD-6.7L	KD-6.7L	HD-6.7L	48 X 100	
MD-6.8L			55 X 100	
MD-6.9L			75 X 75	
MD-7L			70 X 100	
MD-7.1L			75 X 100	
MD-7.2L			100 X 50	
MD-7.5L			100 X 75	
MD-8L	KD-8L	HD-8L	100 X 100	
MD-9L			120 X 75	
MD-10L			150 X 75	
MD-12L			150 X 100	
MD-15L			200 X 100	
MD-21L			200 X 150	
MD-22L			200 X 200	
MD-30L			300 X 100	

FIXING SLOT  
For width :  
25mm, 33mm, 40mm,  
45mm, 50mm, 60mm

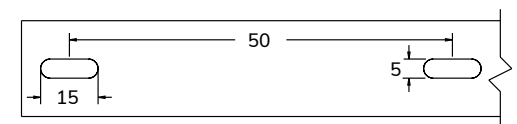

# 0101 KSS WIRING DUCT (SLOTTED)



- Material: **UL94V-0** and **M1** flame rated, UL approved PVC.
- Color: Grey.
- PVC service temperature: 85°C
- UL Test up to 50°C
- These devices are for routing of wires within devices in factory installations.
- Features parallel holes on both sidewalls to facilitate cutting in wire application.
- Special color, size, length upon request of reasonable quantity.

※The standard wiring duct can be available for non-slip cover, suitable for vertical installations. The item number please specify for example,  
 Item no. : VD-8→VQ-8, KVD-8→KVQ-8, HVD-8→HVQ-8  
 Non-slip cover for the size less than 20mm width or bigger than 125mm is available upon request.

Item No.			W x H	Length
SLOT				
8mm	6mm	4mm	mm	
VD-1		HVD-1	25 X 30	2M
VD-1.5		HVD-1.5	30 X 30	
VD-2		HVD-2	25 X 40	
VD-3		HVD-3	33 X 40	
VD-4	KVD-4	HVD-4	40 X 40	
VD-5		HVD-5	60 X 40	
VD-5.5		HVD-5.5	80 X 40	
VD-5.7		HVD-5.7	100 X 40	
VD-6		HVD-6	25 X 60	
VD-7	KVD-7	HVD-7	40 X 60	
VD-8	KVD-8	HVD-8	60 X 60	
VD-9		HVD-9	80 X 60	
VD-9.5		HVD-9.5	100 X 60	
VD-9.6		HVD-9.6	120 X 60	
VD-9.65		HVD-9.65	120 X 65	
VD-9.66		HVD-9.66	25 X 80	
VD-9.7		HVD-9.7	40 X 80	
VD-9.8		HVD-9.8	60 X 80	
VD-10		HVD-10	80 X 80	
VD-10.5		HVD-10.5	100 X 80	
VD-11		HVD-11	120 X 80	
VD-12		HVD-12	40 X 100	
VD-13		HVD-13	60 X 100	
VD-14		HVD-14	80 X 100	
NEW VD-16			120X 100	



**HVD** SLOT : 4mm

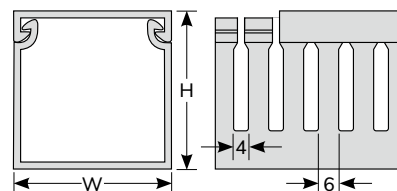

**KVD** SLOT : 6mm

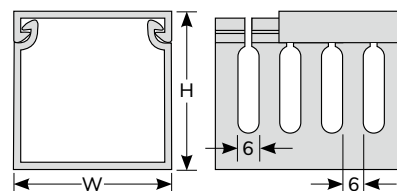

**VD** SLOT : 8mm

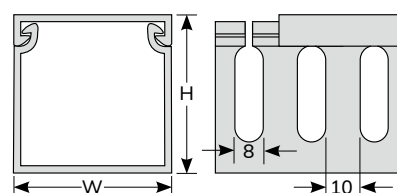

Wiring Ducts

Cable Markers

Cable Ties

Wrapping Bands

Cable Clamps & Tie Mounts

Glands, Bushings

Conduits

Bushings

Wire Connectors

Tubes

Cable Clips

PCB Parts

Fasteners

## 0101A KSS WIRING DUCT CUTTER

Item No : WT-1



Blade length : 62mm

Item No : WT-2



Blade length : 77mm



# 0101 KSS WIRING DUCT (CLOSE SLOTTED)

Wiring Ducts

Cable Markers

Cable Ties

Wrapping Bands

Cable Clamps & Tie Mounts

Glands, Bushings

Conduits

Bushings

Wire Connectors

Tubes

Cable Clips

PCB Parts

Fasteners

- Material: **UL94V-0** and **M1** flame rated, UL approved PVC.
  - Color: Grey.
  - PVC service temperature: 85°C
  - Close slot design facilitate easy installation or removal of cover.
  - LDC series with larger slot is suitable for big wire, and vaporize the heat from cables much quickly.
  - Slot can be cut when enlarge slot is necessary.
- ※The standard wiring duct can be available for non-slip cover, suitable for vertical installations. The item number please specify for example,  
Item no. : VDC-2530→VQC-2530  
Non-slip cover for the size less than 20mm width or bigger than 125mm is available upon request.

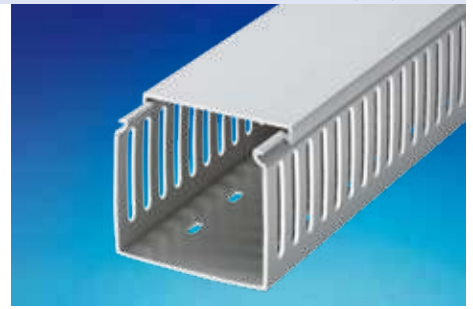

**VDC** SLOT : 8mm

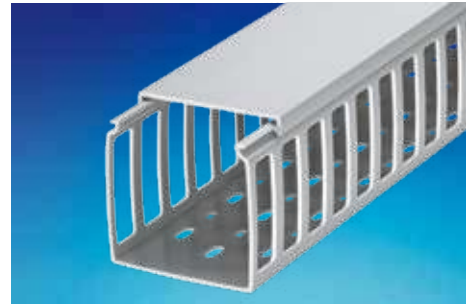
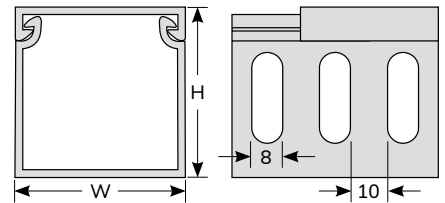

**LDC** SLOT : 17mm

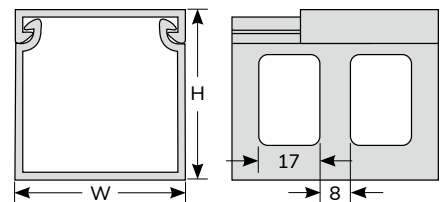

Item No.		W x H	Length
SLOT			
8mm	17mm	mm	
VDC-2530		25 X 30	2M
VDC-4040		40 X 40	
VDC-8040		80 X 40	
VDC-5050		50 X 50	
VDC-2560		25 X 60	
VDC-4060	LDC-4060	40 X 60	
VDC-6060	LDC-6060	60 X 60	
VDC-8060	LDC-8060	80 X 60	
	LDC-3365	33 X 65	
	LDC-4565	45 X 65	
	LDC-6565	65 X 65	
VDC-4080	LDC-4080	40 X 80	
VDC-6080	LDC-6080	60 X 80	
VDC-8080	LDC-8080	80 X 80	
	LDC-33100	33 X 100	
VDC-40100		40 X 100	
	LDC-48100	48 X 100	
VDC-100100	LDC-100100	100 X 100	

# 0101B KSS WIRING DUCT ASSEMBLE TOOL

- Material: UL94V-2 flame rated, UL approved Nylon 66.
- Color: Black
- Application: To interlock the tool hook side with duct lid hook, press lightly the duct side wall and walk the tool blade forward, duct lid will be easily mounted on duct base.
- Function: To cover slotted type wiring duct lid easily with its base.



Item No.	Dimension	Packing
WA-1	As Figure	10PCS



Film

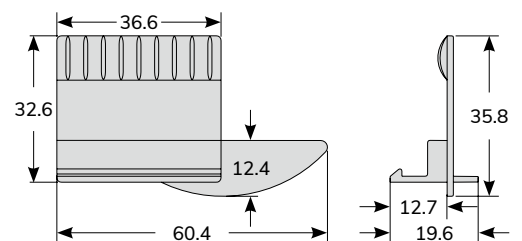



# 0101 KSS WIRING DUCT (SLOTTED)



- Material: **UL94V-0** and **M1** flame rated, UL approved PVC.
- Color: Grey.
- PVC service temperature: 85°C
- UL Test up to 50°C
- These devices are for routing of wires within devices in factory installations.
- Features parallel holes on both sidewalls to facilitate cutting in wire application.

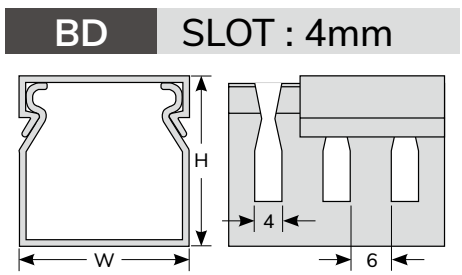

Item No.	W x H	Length
SLOT	mm	
BD-2525	25 X 25	2M
BD-3340	33 X 40	
BD-4040	40 X 40	
BD-3360	33 X 60	
BD-4860	48 X 60	
BD-6060	60 X 60	

# 0101 KSS WIRING DUCT (SLOTTED)



- Material: **UL94V-0** and **M1** flame rated, UL approved PVC.
  - Color: Grey.
  - PVC service temperature: 85°C
  - UL Test up to 50°C
  - 4.5mm SLOT with score line.
- ※The standard wiring duct can be available for non-slip cover, suitable for vertical installations. The item number please specify for example,



Item no. : **GD-3060**→**GQ-3060**

Non-slip cover for the size less than 20mm width or bigger than 125mm is available upon request.

Item No.	W x H	Length
SLOT	mm	
GD-3060	30 X 60	2M
GD-4060	40 X 60	
GD-6060	60 X 60	
GD-8060	80 X 60	
GD-10060	100 X 60	
GD-12060	120 X 60	
GD-3080	30 X 80	
GD-4080	40 X 80	
GD-6080	60 X 80	
GD-8080	80 X 80	
GD-10080	100 X 80	
GD-12080	120 X 80	

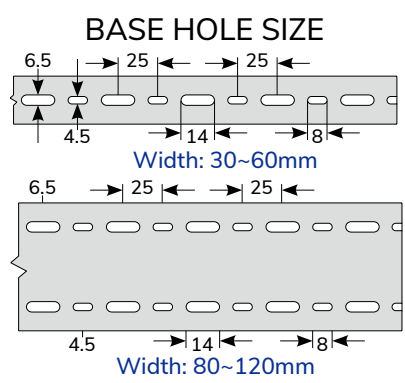
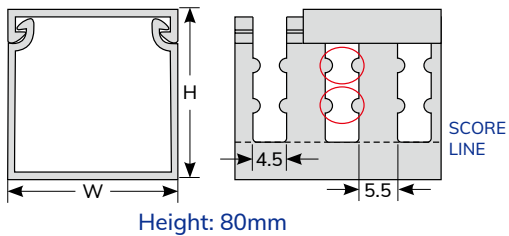
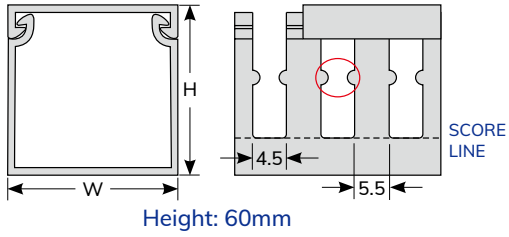

Wiring Ducts  
Cable Markers  
Cable Ties  
Wrapping Bands  
Cable Clamps & Tie Mounts  
Glands, Bushings  
Conduits  
Bushings  
Wire Connectors  
Tubes  
Cable Clips  
PCB Parts  
Fasteners

# 0101 KSS WIRING DUCT (SLOTTED)

- Material: **UL94V-0** and **M1** flame rated, UL approved PVC.
- Color: Grey.
- PVC service temperature: 85°C
- UL Test up to 50°C
- Double Score lines: The restricted slot, sidewall design is scored at the base of each finger and the base of duct. It is easy for the user to break finger from the base to enlarge bundle of wire.
- Pinch Points: To separate the wires from top and bottom to avoid the wires tangled.
- Narrow and Larger Fingers: Both are available to supply the installer for different application.
- Outward sidewall design: Provide the resistance to prevent the cover/lid slipping off.
- ※ The standard wiring duct can be available for non-slip cover, suitable for vertical installations. The item number please specify for example,  
 Item no. : MPD-2550→MPQ-2550, PD-2550→PQ-2550,  
 MID-2530→MIQ-2530, HID-2560→HIQ-2560  
 Non-slip cover for the size less than 20mm width or bigger than 125mm is available upon request.

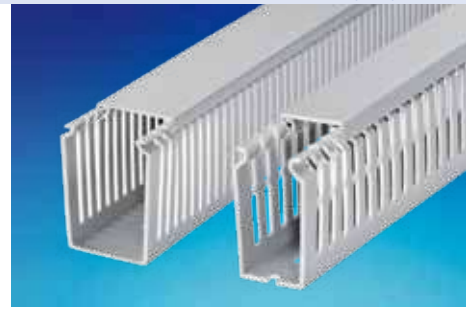

**MPD** SLOT : 8mm

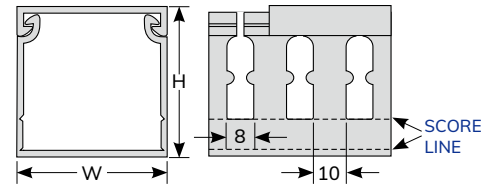

**PD** SLOT : 5mm

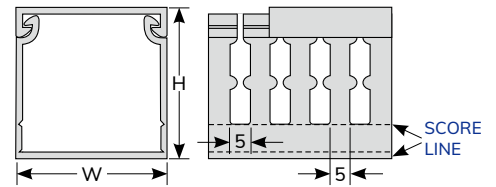

**MID** SLOT : 8mm

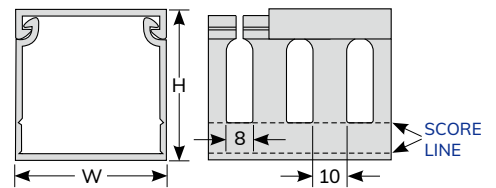

**HID** SLOT : 4mm

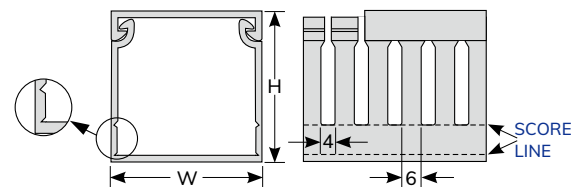

Item No.				W x H	Length
SLOT					
8mm	5mm	8mm	4mm	mm	
		MID-2530		25 X 30	2M
		MID-2540		25 X 40	
MPD-2550	PD-2550			25 X 50	
			HID-2560	25 X 60	
MPD-2575	PD-2575			25 X 75	
			HID-2580	25 X 80	
			HID-4080	40 X 80	
MPD-5050	PD-5050			50 X 50	
MPD-5075	PD-5075			50 X 75	
			HID-6080	60 X 80	
MPD-7575	PD-7575			75 X 75	
MPD-100100	PD-100100			100 X 100	

# 0102 KSS HALOGEN FREE WIRING DUCT

- Material: **UL94V-0** flame rated, UL approved PC/ABS, Halogen FREE.
- Color : Grey.
- PC/ABS service temperature: 100°C
- Features parallel holes on both sidewalls to facilitate cutting in wire application.



**MHF** SLOT : 8mm

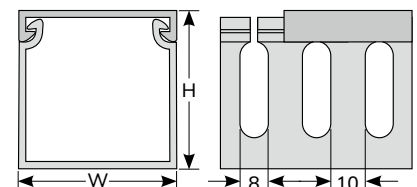

Item No.	W x H	Length
SLOT		
8mm	mm	
MHF-4040	40 X 40	2M

# 0101 KSS WIRING DUCT (SLOTTED)

- Material: **UL94V-0** and **M1** flame rated, UL approved PVC.
- Color: Grey.
- PVC service temperature: 85°C
- UL Test up to 50°C
- These devices are for routing of wires within devices in factory installations.
- Feature: parallel holes on both sidewalls to facilitate cutting in wire application.

※The standard wiring duct can be available for non-slip cover, suitable for vertical installations. The item number please specify for example,

Item no. : AD-1X2▶AQ-1X2, HD-1X2▶HQ-1X2,  
SD-1.5X1▶SQ-1.5X1

Non-slip cover for the size less than 20mm width or bigger than 125mm is available upon request.



**AD** SLOT : 8mm

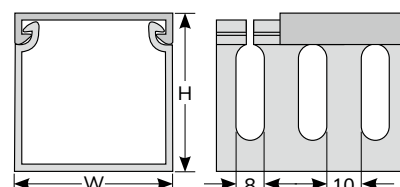

**HD** SLOT : 4mm

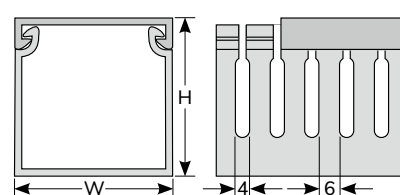

**SD** SOLID

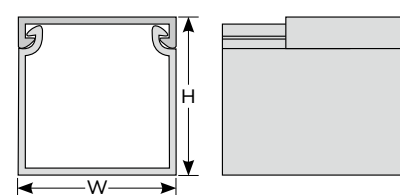

Item No.			W x H mm	Length
SLOT		SOLID		
8mm	4mm			
AD-1 X 2	HD-1 X 2	SD-1 X 2	25 X 50	2M
AD-1 X 3	HD-1 X 3	SD-1 X 3	25 X 75	
AD-1.5 X 1		SD-1.5 X 1	38 X 25	
AD-1.5 X 2	HD-1.5 X 2	SD-1.5 X 2	38 X 50	
AD-1.5 X 3	HD-1.5 X 3	SD-1.5 X 3	38 X 75	
AD-2 X 1	HD-2 X 1	SD-2 X 1	50 X 25	
AD-2 X 2		SD-2 X 2	50 X 50	
AD-2 X 3	HD-2 X 3	SD-2 X 3	50 X 75	
AD-3 X 2	HD-3 X 2	SD-3 X 2	75 X 50	
AD-3 X 3	HD-3 X 3	SD-3 X 3	75 X 75	
AD-3 X 4		SD-3 X 4	75 X 100	

# 0104 KSS FLEXIBLE WIRING DUCT

- Material: UL94V-2 flame rated, UL approved Nylon 66.
- Color: Grey.
- Feature: with connector design at both end, ducts can conjoint each other.



Item No.	W	H	SLOT	Length
	mm	mm	mm	
FD-20	20.4	14.4	8.2	50cm
FD-30	29.0	24.9	8.2	

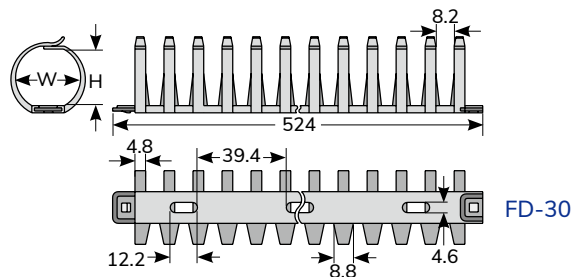
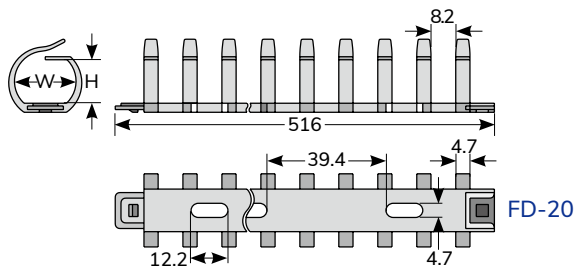

# 0105 KSS WIRING DUCT (SOLID)

SOLID: No slot design, for external wiring or where wire extraction is not necessary.

- Material: **UL94V-0** and **M1** flame rated, UL approved PVC.
- Color: Grey.
- PVC service temperature: 85°C
- UL Test up to 50°C
- These devices are for routing of wires within devices in factory installations.
- Solid type can protect wire from dust or external damage by mouse.
- Special color, size, length upon request at reasonable quantity.

※ The standard wiring duct can be available for non-slip cover, suitable for vertical installations. The item number please specify for example,

Item no. : SD-2525 → SQ-2525

Non-slip cover for the size less than 20mm width or bigger than 125mm is available upon request.

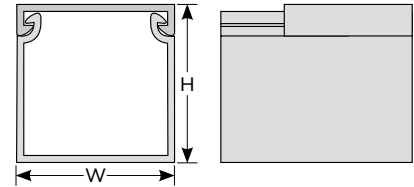
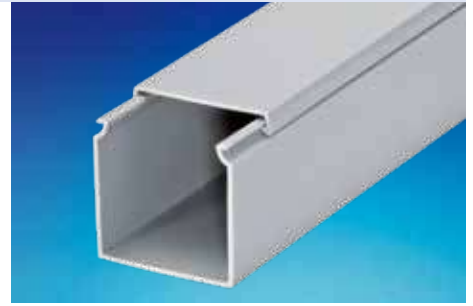

Item No.	W x H		Length	Item No.	W x H		Length
	mm				mm		
SD-1616	16 X 16		2M	SD-7550	75 X 50		2M
SD-2516	25 X 16			SD-10050	100 X 50		
SD-3816	38 X 16			SD-4060	40 X 60		
SD-2020	20 X 20			SD-6060	60 X 60		
SD-4020	40 X 20			SD-8060	80 X 60		
SD-1525	15 X 25			SD-10060	100 X 60		
SD-2525	25 X 25			SD-4565	45 X 65		
SD-3825	38 X 25			SD-6565	65 X 65		
SD-5025	50 X 25			SD-5075	50 X 75		
SD-3333	33 X 33			SD-7575	75 X 75		
SD-3340	33 X 40			SD-10075	100 X 75		
SD-4040	40 X 40			SD-15075	150 X 75		
SD-6040	60 X 40			SD-4080	40 X 80		
SD-7540	75 X 40			SD-6080	60 X 80		
SD-8040	80 X 40			SD-8080	80 X 80		
SD-10040	100 X 40			SD-80100	80 X 100		
SD-3345	33 X 45			SD-100100	100 X 100		
SD-4545	45 X 45			SD-150100	150 X 100		
SD-6545	65 X 45			SD-200100	200 X 100		
SD-5050	50 X 50			SD-200100J	200 X 100		
			SD-300100	300 X 100			

▲ Other types of wiring duct can be customized.

# 0101 KSS NON-SLIP WIRING DUCT COVER

- Material: **UL94V-0** and **M1** flame rated, UL approved PVC with PE copolymer.
- Color: Grey.
- Feature: Neat and stable gluey layer inside duct cover tightens the base and cover more firmly. Cover won't slide easily and stays in place for vertical orientation. Installation will be convenient and safe.

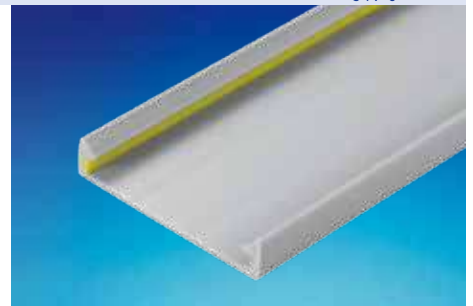
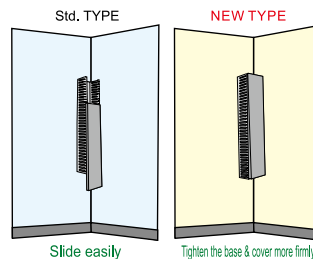

Item No.						Length
DCQ-20L	DCQ-33L	DCQ-50L	DCQ-65L	DCQ-75L	DCQ-120L	2M
DCQ-25L	DCQ-40L	DCQ-55L	DCQ-70L	DCQ-80L	DCQ-125L	
DCQ-30L	DCQ-45L	DCQ-60L	DCQ-72L	DCQ-100L		

# 0105 KSS WIRING DUCT CONNECTOR

- Material: UL94HB flame rated, UL approved ABS.
- Function: Apply with SD type wiring duct to connect ducts easy and neatly.

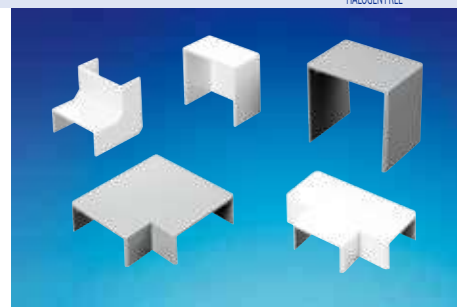

Connectors	Type	Item No.	Used With	Packing	Connectors	Type	Item No.	Used With	Packing		
	MID-WAY CONNECTOR	SDM-1616	SD-1616	20pcs		OUTSIDE CORNER	SDO-1616	SD-1616	20pcs		
		SDM-2516	SD-2516				SDO-2516	SD-2516			
		SDM-3816	SD-3816				<b>NEW</b> SDO-2525	SD-2525			
		SDM-4040	SD-4040				SDO-3816	SD-3816			
		SDM-5050	SD-5050				SDO-4040	SD-4040			
		SDM-7575	SD-7575				SDO-5050	SD-5050			
	"T" TYPE	SDT-1616	SD-1616		20pcs		"L" TYPE	SDL-1616		SD-1616	20pcs
		SDT-2516	SD-2516					SDL-2516		SD-2516	
		<b>NEW</b> SDT-2525	SD-2525					<b>NEW</b> SDL-2525		SD-2525	
		SDT-3816	SD-3816					SDL-3816		SD-3816	
		SDT-4040	SD-4040					SDL-4040		SD-4040	
		SDT-5050	SD-5050					SDL-5050		SD-5050	
	INSIDE CORNER	SDI-1616	SD-1616	20pcs		END PIECE	SDE-1616	SD-1616	20pcs		
		SDI-2210D	SD-2210				SDE-2210	SD-2210			
		SDI-2516	SD-2516				SDE-2516	SD-2516			
		<b>NEW</b> SDI-2525	SD-2525				SDE-3816	SD-3816			
		SDI-3816	SD-3816				SDE-4040	SD-4040			
		SDI-4040	SD-4040				SDE-5050	SD-5050			
		SDI-5050	SD-5050				SDE-7575	SD-7575			
		SDI-7575	SD-7575								

# 0105 KSS MINI TRUNKING

- Material: UL94V-0 and M1 flame rated, UL approved PVC.
- Color : White.
- PVC service temperature: 85°C
- Solid type can protect wire from dust or external damage by mouse.



Item No.	W x H	Length
	mm	
UD-1809WE	18 X 10.2	2M
UD-1616WE	16 X 16	
UD-2516WE	25 X 16	
UD-4016WE	40 X 16	
UD-4025WE	40 X 25	
UD-5025WE	50 X 25	

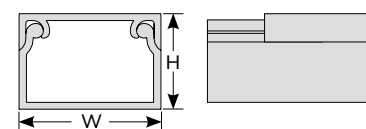
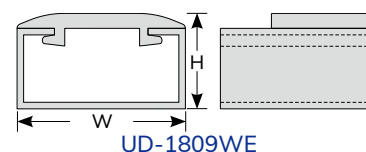

# 0105 KSS WIRING DUCT

- Material: **UL94V-0** and **M1** flame rated, UL approved PVC.
- Color: Grey.
- PVC service temperature: 85°C
- Feature: Special designed hook and slot base, makes installation easier and faster. Apply with L type coupler to connect wiring ducts easily.
- Fixing slot on duct base designs to help cooling cable faster.
- ※ SDH-15060, SDH-150100, SDH-200100 please reference the structure design of P.16

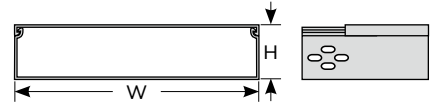

SDH-15060, 150100, 200100, 200100J, 300100

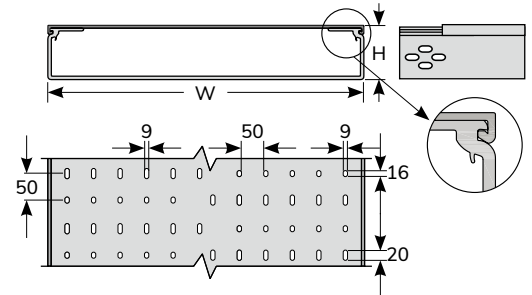
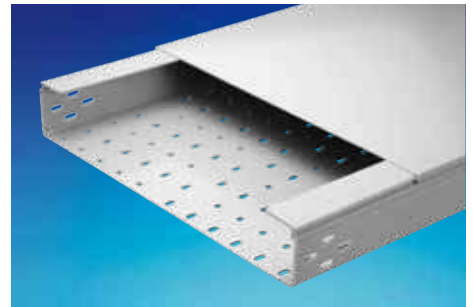

SDH-300100J, 400100, 500100J, 600100

Item No.	W x H		Length
	mm		
<b>NEW</b> SDH-15060	150 X 60		2M (3M available upon request)
<b>NEW</b> SDH-150100	150 X 100		
<b>NEW</b> SDH-200100J	200 X 100		
<b>NEW</b> SDH-200100	200 X 100		
SDH-300100	300 X 100		
SDH-300100J	300 X 100		2M (3M available upon request)
SDH-400100	400 X 100		
SDH-500100J	500 X 100		
SDH-600100	600 X 100		

# 0105 KSS WIRING DUCT

- Material: **UL94V-0** and **M1** flame rated, UL approved PVC.
- Color: Grey.
- PVC service temperature: 85°C
- Feature: light weight, hollow wall design.

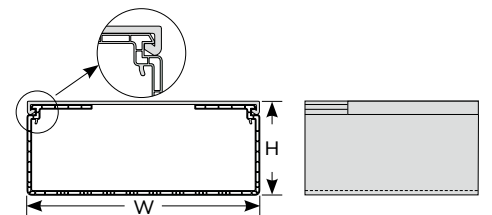

Item No.	W x H		Length
	mm		
ZD-300100	300 X 100		2M (3M available upon request)

Wiring Ducts

Cable Markers

Cable Ties

Wrapping Bands

Cable Clamps & Tie Mounts

Glands, Bushings

Conduits

Bushings

Wire Connectors

Tubes

Cable Clips

PCB Parts

Fasteners

# 0105 KSS WIRING DUCT CONNECTOR

<p><b>(A)</b> Base Without Fixing Hole (2M)</p> <p>SDB</p>	<p><b>(B)</b> Base With Fixing Hole (2M)</p> <p>SDHB</p>	<p><b>(C)</b> Downward Connector (duct cover)</p> <p>45° 90°</p> <p>SDHA SDHO</p>	<p><b>(D)</b> Upward Connector (duct cover)</p> <p>45° 90°</p> <p>SDHV SDHI</p>
<p><b>(E)</b> Connector "L" TYPE (duct cover)</p> <p>90° 45°</p> <p>SDHL SDHF</p>	<p><b>(F)</b> Connector "T" TYPE (duct cover)</p> <p>SDHT</p>	<p><b>(G)</b> Connector "Cross" TYPE (duct cover)</p> <p>SDHX</p>	<p><b>(H)</b> Cover (2M)</p> <p>DC</p>
<p><b>(I)</b> END PIECE</p> <p>SDE</p>	<p><b>(J)</b> T Type Connector Parts</p> <p>DCPT1</p>	<p><b>(K)</b> Reinforce Connector</p> <p>DCP-100A</p>	<p><b>(L)</b> Reinforce Connector &amp; Separator</p> <p>DCP-100</p>
<p><b>(M)</b> Angle Adjuster</p> <p>DCI-100</p>	<p><b>(N)</b> Angle Adjuster</p> <p>DCI-60</p>	<p><b>Other types of wiring duct can be customized.</b>  Connectors <b>(C) (D) (E) (F) (G)</b> includes cover and base. To order base only add a "B" after the model number.  Example: For wiring Duct model no. SDH-400100, full set downward connector no. is SDHA-400100, base model no. is SDHAB-400100, cover model no. is DCA-400100.  Connecting wiring duct and connector require 2 couplers. To fix a single coupler requires 6 screws and nuts.</p>	

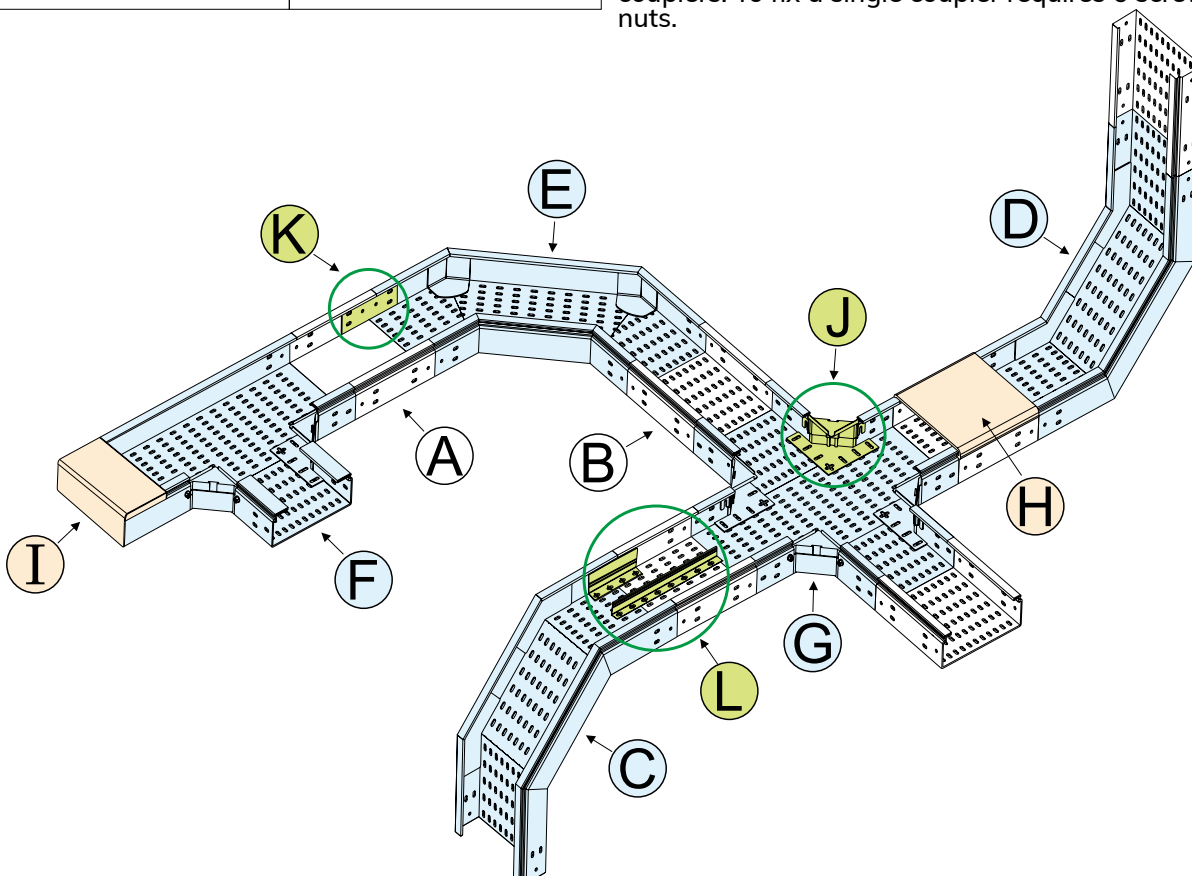

# 0105 KSS WIRING DUCT COUPLER

Wiring Ducts

- Material:UL94HB flame rated, UL approved ABS.
- Color: Grey.
- Application: 1. DCP-100, DCP-60A, DCP-100A: apply 1 coupler on each side and fix with 6 screw and nuts. DCP-100 also functions as divider plate.
- 2. DCI-60, DCI-100:1set includes 2 couplers and screws. Apply 2 couplers each side and fix with 6 screws and nuts to adjust angle.
- 3. DCPT-1:1 set includes cover and base. To connect wiring duct at 90 degree needs to apply 1 set each side.

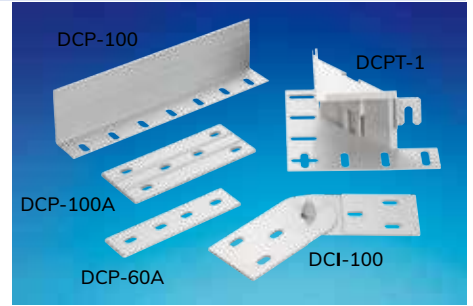

Cable Markers

Cable Ties

▲ DCP-100 UL94V-0 and M1 flame rated, UL approved PVC, service temperature: 85°C.

※Applied with screw PF-823HNGYJ and nut PN-8HNGYJ

Wrapping Bands

Cable Clamps & Tie Mounts

Item No.	H	Length	Used With SDH duct Height	Packing
	mm	mm		
●DCP-100	75.5	350	100 mm	1pcs
DCP-60A	43.0	170	60 mm	
DCP-100A	75.0	184.6	100 mm	
DCP-100B	75.0	269.4	100 mm	
DCI-60	43.0	130	60 mm	1 set
DCI-100	75.0	160	100 mm	(with 2pcs & screw as picture)
DCPT-1	58.5	190	100 mm	1 set (with top & bottom as picture)



(Refer to P.215)

Glands, Bushings

Conduits

Bushings

Wire Connectors

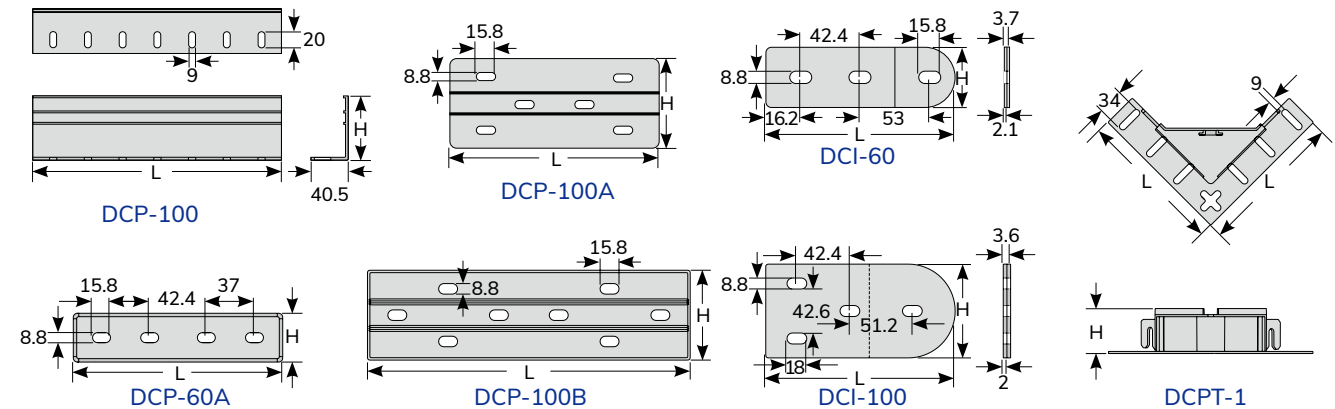

Tubes

# 0106 KSS WIRE RETAINER

- Material: UL94HB flame rated, UL approved ABS.
- Color: Grey.
- Fix wire retainer by adhesive tape first and put wires inside.
- To make wires in good order and neatly.



Cable Clips

PCB Parts

Fasteners

Item No.	W x H	Packing
	mm	
LS-2040	20 X 40	100pcs With Adhesive Tape
LS-4040	40 X 40	
LS-7040	70 X 40	
LS-2065	20 X 65	
LS-4065	40 X 65	
LS-6565	65 X 65	

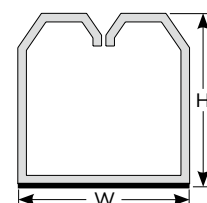



# 0106 KSS WIRE SADDLE

- Material: UL94HB flame rated, UL approved ABS.
- Color: Black.
- Fix wire saddle by screw first and put wires inside.
- To make wires in good order and neatly.



Item No.	W x H	Packing
	mm	
LS-4267	42 X 69	50pcs

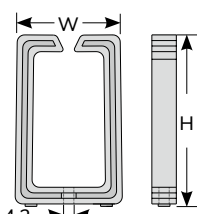

Screw hole dia. 4.2

Wiring Ducts

Cable Markers

Cable Ties

Wrapping Bands

# 1125 KSS SNAP RIVET

- Material: UL94V-2 flame rated, UL approved Nylon 66.
- Color: Black
- Feature: substitute for metal screw, with great insulating property.



Item No.	H1	For		Packing
		Mounting Hole M1	Panel thickness T1	
	mm	mm	mm	
SR-0612K	12.3	6.4	7.0-10.0	1000pcs
SR-0815K	14.0	8.2	7.0-12.0	

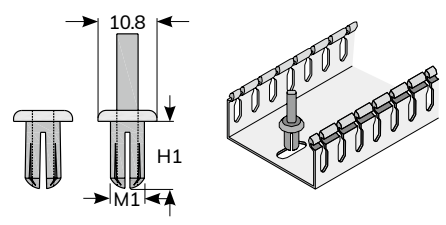

Cable Clamps & Tie Mounts

Glands, Bushings

Conduits

Bushings

# 0107 KSS MULTI-COMPARTMENT WIRING DUCT

- Material: **UL94V-0** and **M1** flame rated, UL approved PVC.
- Color: White
- PVC service temperature: 85°C
- Feature: with divider wall to easy categorize different cables.
- ※ WD-11060WE without divider wall



Item No.	W	H	W1	W2	W3	Length
	mm	mm	mm	mm	mm	
WD-2010-2WE	20	10.3	7.5	7.5		2M
WD-3010-2WE	30	11.2	12.5	12.5		
WD-4010-3WE	40	10.3	11.0	11.5	11.5	
WD-5020-3WE	50.8	20.3	14.8	10.0	14.8	
WD-10040-3WE	100	40.0	32.8	23.2	32.8	
※ WD-11060WE	111	61.4	43.3	16.0	43.3	

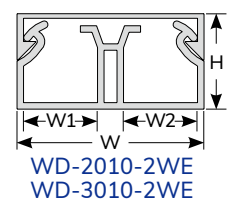

WD-2010-2WE  
WD-3010-2WE

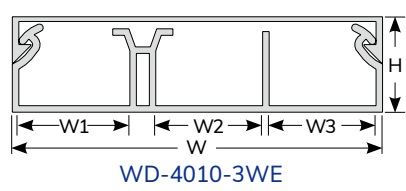

WD-4010-3WE

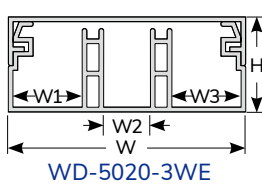

WD-5020-3WE

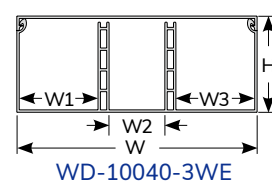

WD-10040-3WE

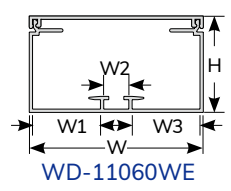

WD-11060WE

Wire Connectors

Tubes

Cable Clips

PCB Parts

Fasteners

# 0108 KSS WIRING DUCT CONNECTOR

- Material: UL94HB flame rated, UL approved ABS.
- Color: White

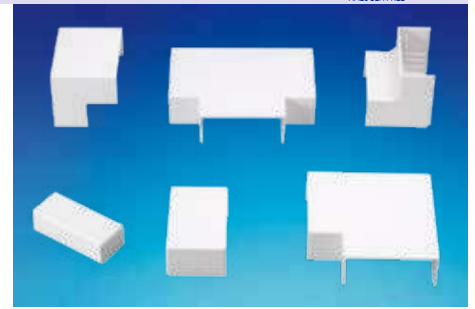

Connectors	Type	Item No.	Used With	Packing	
	MID-WAY CONNECTOR	WDM-2010WE	WD-2010-2WE	20pcs	
		WDM-3010WE	WD-3010-2WE		
		WDM-4010WE	WD-4010-3WE		
		WDM-5020WE	WD-5020-3WE		
	"T" TYPE	WDT-2010WE	WD-2010-2WE		
		WDT-3010WE	WD-3010-2WE		
		WDT-4010WE	WD-4010-3WE		
		WDT-5020WE	WD-5050-3WE		
	INSIDE CORNER	WDI-2010WE	WD-2010-2WE		10pcs
		WDI-3010WE	WD-3010-2WE		
		WDI-4010WE	WD-4010-3WE		
		WDI-5020WE	WD-5020-3WE		
		WDI-11060WE	WD-11060WE		

Connectors	Type	Item No.	Used With	Packing
	OUTSIDE CORNER	WDO-2010WE	WD-2010-2WE	20pcs
		WDO-3010WE	WD-3010-2WE	
		WDO-4010WE	WD-4010-3WE	
		WDO-5020WE	WD-5020-3WE	
		WDO-11060WE	WD-11060WE	
	"L" TYPE	WDL-2010WE	WD-2010-2WE	20pcs
		WDL-3010WE	WD-3010-2WE	
		WDL-4010WE	WD-4010-3WE	
		WDL-11060WE	WD-11060WE	
	END PIECE	WDE-2010WE	WD-2010-2WE	20pcs
		WDE-3010WE	WD-3010-2WE	
		WDE-4010WE	WD-4010-3WE	
		WDE-5020WE	WD-5020-3WE	

# 0112 KSS DECORATION WIRING DUCT CONNECTOR

- Material: UL94HB flame rated, UL approved ABS.
- Color: Grey, Brown(BN), Dark Brown(DB), White(WE), Milk(MW),e.g. TFM-2MW

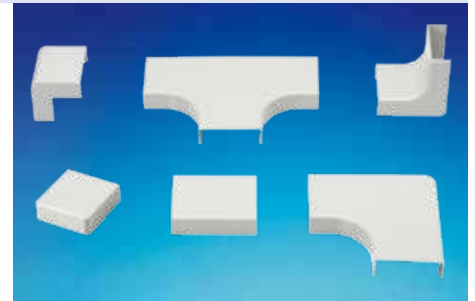

Connectors	Type	Item No.	Used With	Packing
	MID-WAY CONNECTOR	TFM-1	TF-1	20pcs
		TFM-2	TF-2	
		TFM-3	TF-3	
		TFM-4	TF-4	
		TFM-5	TF-5	
		TFM-6	TF-6	
	"T" TYPE	TFT-1	TF-1	
		TFT-2	TF-2	
		TFT-3	TF-3	
		TFT-4	TF-4	
		TFT-5	TF-5	
		TFT-6	TF-6	
	INSIDE CORNER	TFI-1	TF-1	
		TFI-2	TF-2	
		TFI-3	TF-3	
		TFI-4	TF-4	
		TFI-5	TF-5	
		TFI-6	TF-6	

Connectors	Type	Item No.	Used With	Packing
	OUTSIDE CORNER	TFO-1	TF-1	20pcs
		TFO-2	TF-2	
		TFO-3	TF-3	
		TFO-4	TF-4	
		TFO-5	TF-5	
		TFO-6	TF-6	
	"L" TYPE	TFL-1	TF-1	
		TFL-2	TF-2	
		TFL-3	TF-3	
		TFL-4	TF-4	
		TFL-5	TF-5	
		TFL-6	TF-6	
	END PIECE	TFE-1	TF-1	
		TFE-2	TF-2	
		TFE-3	TF-3	
		TFE-4	TF-4	
		TFE-5	TF-5	
		TFE-6	TF-6	

# 0110 KSS DECORATION WIRING DUCT



- Material: **UL94V-0** and **M1** flame rated, UL approved PVC.
- Color: Grey. (Brown, Dark Brown, White, Milk, Light Grained, Dark Grained available.)
- PVC service temperature: 85°C
- UL Test up to 50°C
- Feature: All sizes feature same height in 11mm which are especially designed for flat cables.
- Provides a round fixing hole at the duct base. The duct bottom is with adhesive tape too. Cloth adhesive and foam adhesive are available.



Wiring Ducts

Cable Markers

Cable Ties

Wrapping Bands

Cable Clamps & Tie Mounts

Glands, Bushings

Conduits

Bushings

Wire Connectors

Tubes

Cable Clips

PCB Parts

Fasteners

Item No.		Color	W mm	H mm	L
Without Adhesive Tape	With Adhesive Tape				
TF-1	TF-1T	Grey	12.7 (1/2")	11	2M
TF-2	TF-2T	Grey	19.0 (3/4")	11	
TF-3	TF-3T	Grey	25.4 (1")	11	
TF-4	TF-4T	Grey	31.8 (1 1/4")	11	
TF-5	TF-5T	Grey	38.1 (1 1/2")	11	
TF-6	TF-6T	Grey	50.8 (2")	11	
TF-11	TF-11T	Grey	12.7 (1/2")	11	1M
TF-11BN	TF-11TBN	Brown			
TF-11DB	TF-11TDB	Dark Brown			
TF-11WE	TF-11TWE	White			
TF-11MW	TF-11TMW	Milk			
TF-11BK	TF-11TBK	Black			
TF-11LX	TF-11TLX	Light Grained			
TF-11DX	TF-11TDX	Dark Grained			
TF-21	TF-21T	Grey			
TF-21BN	TF-21TBN	Brown			
TF-21DB	TF-21TDB	Dark Brown			
TF-21WE	TF-21TWE	White			
TF-21MW	TF-21TMW	Milk			
TF-21BK	TF-21TBK	Black			
TF-21LX	TF-21TLX	Light Grained			
TF-21DX	TF-21TDX	Dark Grained			
TF-31	TF-31T	Grey			
TF-31BN	TF-31TBN	Brown			
TF-31DB	TF-31TDB	Dark Brown			
TF-31WE	TF-31TWE	White			
TF-31MW	TF-31TMW	Milk			
TF-31BK	TF-31TBK	Black			
TF-31LX	TF-31TLX	Light Grained			
TF-31DX	TF-31TDX	Dark Grained			

Item No.		Color	W mm	H mm	L
Without Adhesive Tape	With Adhesive Tape				
TF-41	TF-41T	Grey	31.8 (1 1/4")	11	1M
TF-41BN	TF-41TBN	Brown			
TF-41DB	TF-41TDB	Dark Brown			
TF-41WE	TF-41TWE	White			
TF-41MW	TF-41TMW	Milk			
TF-41BK	TF-41TBK	Black			
TF-41LX	TF-41TLX	Light Grained			
TF-41DX	TF-41TDX	Dark Grained			
TF-51	TF-51T	Grey			
TF-51BN	TF-51TBN	Brown			
TF-51DB	TF-51TDB	Dark Brown			
TF-51WE	TF-51TWE	White			
TF-51MW	TF-51TMW	Milk			
TF-51LX	TF-51TLX	Light Grained			
TF-51DX	TF-51TDX	Dark Grained			
TF-61	TF-61T	Grey			
TF-61BN	TF-61TBN	Brown			
TF-61DB	TF-61TDB	Dark Brown			
TF-61WE	TF-61TWE	White			
TF-61MW	TF-61TMW	Milk			
TF-61LX	TF-61TLX	Light Grained			
TF-61DX	TF-61TDX	Dark Grained			

● The color cards are for reference only.

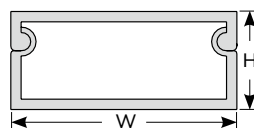

### ■ Double-Sided Tape :

Adhesive Type	Usage Feature	Temperature	Suitable Adhere to
Acrylic Base Adhesvie	To absorb the shock and good resistance to heat	80°C	Tile, Marble, Painted board, board, Stainless steel, Iron Plate, Painted Plate, PP, PE, EVA
Rubber Base Adhesvie	with excellent adhesion and holding power	50°C	

● A Usage Instruction : Adhere/stick surface need to be without dust, wax, oil and water.

## 0113 KSS ONE PIECE WIRING DUCT



- Material: **UL94V-0** and **M1** flame rated, UL approved PVC.
- Color: Ivory.
- PVC service temperature: 85°C
- One piece design. Combines duct base together with its lip. Easy for application and save working time.
- With adhesive tape. Cloth adhesive and foam adhesive are available.

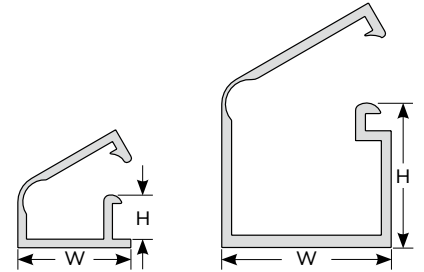

Item No.		W	H	Length
Without Tape	With adhesive Tape	mm	mm	
TF-0905IY	TF-0905TIY	9.2	2.9	2M
TF-1313IY	TF-1313TIY	13.2	10.8	

## 0113 KSS ONE PIECE WIRING DUCT



- Material: **UL94V-0** and **M1** flame rated, UL approved PVC.
- Color: White.
- PVC service temperature: 85°C
- One piece surface raceway is a single channel designed to route, protect and conceal video or power cabling, can be opened and closed repeatedly without cracking.
- Factory applied adhesive backing speeds installation.
- With adhesive tape. Cloth adhesive and foam adhesive are available.

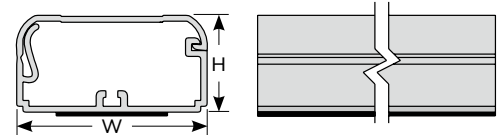
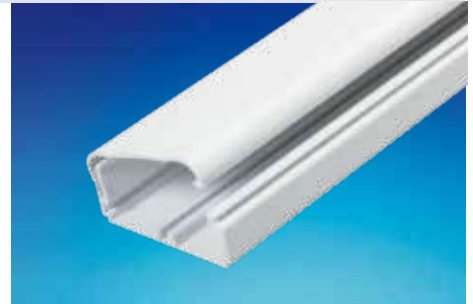

Item No.	W	H	Length
	mm	mm	
OS-2012TWE	20.3	11.9	1.83M with adhesive tape
OS-4020TWE	38.8	19.3	
OS-6322TWE	62.8	22.0	

## 0113 KSS ONE PIECE WIRING DUCT



- Material: **UL94V-0** and **M1** flame rated, UL approved PVC.
- Color: White.
- PVC service temperature: 85°C
- One piece surface raceway is a single channel designed to route, protect and conceal video or power cabling, can be opened and closed repeatedly without cracking.
- With adhesive tape. Cloth adhesive and foam adhesive are available.

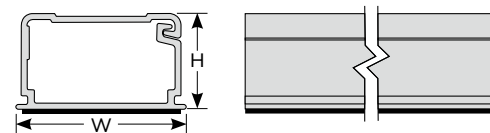

Item No.		W	H	Length
Without Tape	With adhesive Tape	mm	mm	
<b>NEW</b> OP-1714WE	OP-1714TWE	16.9	14.2	1.83M
OP-2013WE	OP-2013TWE	19.5	13.8	
OP-3220WE	OP-3220TWE	31.8	19.6	
OP-4527WE	OP-4527TWE	45.1	27.0	

# 0113 KSS ONE PIECE WIRING DUCT CONNECTOR

- Material: UL94HB flame rated, UL approved ABS.
- Color: White.



Connectors	Type	Item No.	Used With	Packing
	MID-WAY CONNECTOR	<b>NEW</b> OPM-1714WE2	OP-1714WE	5pcs
		OPM-2013WE2	OP-2013WE	
		OPM-3220WE2	OP-3220WE	
		OPM-4527WE2	OP-4527WE	
	"T" TYPE	<b>NEW</b> OPT-1714WE2	OP-1714WE	
		OPT-2013WE2	OP-2013WE	
		OPT-3220WE2	OP-3220WE	
		OPT-4527WE2	OP-4527WE	
	INSIDE CORNER	<b>NEW</b> OPI-1714WE2	OP-1714WE	
		OPI-2013WE2	OP-2013WE	
		OPI-3220WE2	OP-3220WE	
		OPI-4527WE2	OP-4527WE	
	DROP CEILING	OPC-2013WE2	OP-2013WE	
		OPC-3220WE2	OP-3220WE	
		OPC-4527WE2	OP-4527WE	

Connectors	Type	Item No.	Used With	Packing
	OUTSIDE CORNER	<b>NEW</b> OPO-1714WE2	OP-1714WE	5pcs
		OPO-2013WE2	OP-2013WE	
		OPO-3220WE2	OP-3220WE	
		OPO-4527WE2	OP-4527WE	
	"L" TYPE	<b>NEW</b> OPL-1714WE2	OP-1714WE	
		OPL-2013WE2	OP-2013WE	
		OPL-3220WE2	OP-3220WE	
		OPL-4527WE2	OP-4527WE	
	END PIECE	<b>NEW</b> OPE-1714WE2	OP-1714WE	
		OPE-2013WE2	OP-2013WE	
		OPE-3220WE2	OP-3220WE	
		OPE-4527WE2	OP-4527WE	

# 0114 KSS ELECTRICAL BOX

- Material: UL94HB flame rated, UL approved ABS.
- Color: White
- Measurement lines on four sides of base and cover.
- Designed upper cover and base with score lines outside provide the installation solution for wiring duct.



Item No.	Thread	Suitable Wiring Duct W X H	Packing
		mm	
ELBF-1WE1	UNC #6-32	OS-2012TWE、UD-4016、 UD-4025、TF-2、TF-4	1 Set
ELBF-2WE1	W 1/8-40	TF-5	

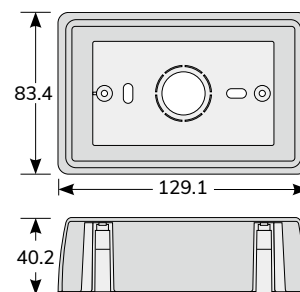

Wiring Ducts

Cable Markers

Cable Ties

Wrapping Bands

Cable Clamps & Tie Mounts

Glands, Bushings

Conduits

Bushings

Wire Connectors

Tubes

Cable Clips

PCB Parts

Fasteners

# 0115 KSS TELEPHONE WIRING DUCT

- Material: **UL94V-0** and **M1** flame rated, UL approved PVC.
- Color: Grey. (Brown, Dark Brown, White, Milk, Light Grained, Dark Grained available.)
- PVC service temperature: 85°C
- UL Test up to 50°C
- Length: 1M (2M available upon request)
- Function: Suitable for telecommunications, surveillance systems and other special environment.
- With adhesive tape. Cloth adhesive and foam adhesive are available.

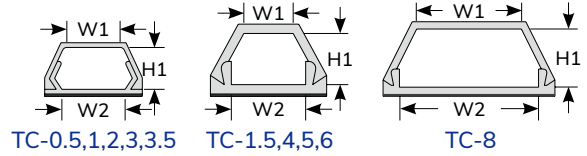

UNIT : mm

Item No.	Color	W1	W2	H1	Length
		mm	mm	mm	
TC-0.5	Grey	7.0	5.0	4.5	1M With Adhesive Tape
TC-0.5BN	Brown				
TC-0.5MW	Milk				
TC-1	Grey	6.0	7.0	4.0	
TC-1BN	Brown				
TC-1DB	Dark Brown				
TC-1WE	White				
TC-1MW	Milk				
TC-1BK	Black	6.0	8.0	7.4	
TC-1.5LX	Light grained				
TC-1.5DX	Dark grained				
TC-2	Grey				
TC-2BN	Brown				
TC-2DB	Dark Brown	8.0	8.0	6.0	
TC-2WE	White				
TC-2MW	Milk				
TC-2BK	Black				
TC-2LX	Light grained				
TC-2DX	Dark grained	10.0	10.0	7.0	
TC-3	Grey				
TC-3BN	Brown				
TC-3DB	Dark Brown				
TC-3WE	White				
TC-3MW	Milk	9.5	14.5	9.5	
TC-3BK	Black				
TC-3LX	Light grained				
TC-3DX	Dark grained				
TC-3.5	Grey				
TC-3.5BN	Brown	9.5	14.5	9.5	
TC-3.5DB	Dark Brown				

Item No.	Color	W1	W2	H1	Length
		mm	mm	mm	
TC-3.5WE	White	9.5	14.5	9.5	1M With Adhesive Tape
TC-3.5MW	Milk				
TC-3.5LX	Light grained				
TC-3.5DX	Dark grained	12.0	15.0	10	
TC-4	Grey				
TC-4BN	Brown				
TC-4DB	Dark Brown				
TC-4WE	White				
TC-4MW	Milk	10.0	17.0	13	
TC-4BK	Black				
TC-4LX	Light grained				
TC-4DX	Dark grained				
TC-5	Grey				
TC-5BN	Brown	11.0	19.0	16	
TC-5DB	Dark Brown				
TC-5WE	White				
TC-5MW	Milk				
TC-5BK	Black				
TC-5LX	Light grained	30.0	37.0	16	
TC-5DX	Dark grained				
TC-6	Grey				
TC-6BN	Brown				
TC-6DB	Dark Brown				
TC-6WE	White	30.0	37.0	16	
TC-6MW	Milk				
TC-6BK	Black				
TC-6LX	Light grained				
TC-6DX	Dark grained				
TC-8	Grey	30.0	37.0	16	
TC-8BN	Brown				
TC-8WE	Dark Brown				
TC-8MW	Milk				
TC-8LX	Light grained				
TC-8DX	Dark grained				

■ The above color cards are for reference only.

# 0116 KSS TELEPHONE WIRING DUCT CONNECTOR



- Material: UL94HB flame rated, UL approved ABS.
- Color: Grey, Brown(BN), Dark Brown(DB), White(WE), Milk(MW).e.g. TCM-2MW



Connectors	Type	Item No.	Used With	Packing
	MID-WAY CONNECTOR	TCM-1	TC-1	20pcs
		TCM-2	TC-2	
		TCM-3	TC-3	
		TCM-4	TC-4	
		TCM-5	TC-5	
		TCM-6	TC-6	
	"T" TYPE	TCT-1	TC-1	
		TCT-2	TC-2	
		TCT-3	TC-3	
		TCT-4	TC-4	
		TCT-5	TC-5	
		TCT-6	TC-6	
	INSIDE CORNER	TCI-1	TC-1	
		TCI-2	TC-2	
		TCI-3	TC-3	
		TCI-4	TC-4	
		TCI-5	TC-5	
		TCI-6	TC-6	

Connectors	Type	Item No.	Used With	Packing
	OUTSIDE CORNER	TCO-1	TC-1	20pcs
		TCO-2	TC-2	
		TCO-3	TC-3	
		TCO-4	TC-4	
		TCO-5	TC-5	
		TCO-6	TC-6	
	"L" TYPE	TCL-1	TC-1	
		TCL-2	TC-2	
		TCL-3	TC-3	
		TCL-4	TC-4	
		TCL-5	TC-5	
		TCL-6	TC-6	
	END PIECE	TCE-1	TC-1	
		TCE-2	TC-2	
		TCE-3	TC-3	
		TCE-4	TC-4	
		TCE-5	TC-5	
		TCE-6	TC-6	

# 0116 KSS TELEPHONE WIRING DUCT CONNECTOR



- Material: UL94HB flame rated, UL approved ABS.
- Color: Grey, Brown(BN), Dark Brown(DB), White(WE), Milk(MW).e.g. TCM-0.5MW

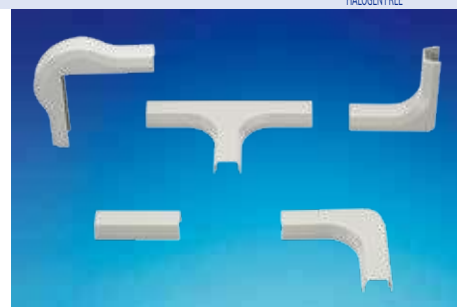

Connectors	Type	Item No.	Used With	Packing
	MID-WAY CONNECTOR	TCM-0.5	TC-0.5	20pcs
	"T" TYPE	TCT-0.5	TC-0.5	
	INSIDE CORNER	TCI-0.5	TC-0.5	
	OUTSIDE CORNER	TCO-0.5	TC-0.5	
	"L" TYPE	TCL-0.5	TC-0.5	

# 0118 KSS TELEPHONE WIRING DUCT (SELF-ADHESIVE)



- Material: **UL94V-0** and **M1** flame rated, UL approved PVC.
- Color: Grey. (Milk, White, Brown available on request)
- PVC service temperature: 85°C
- With adhesive tape. Cloth adhesive and foam adhesive are available.
- Length: 1M (2M available upon request)
- Application: Designed to protect wire on floor

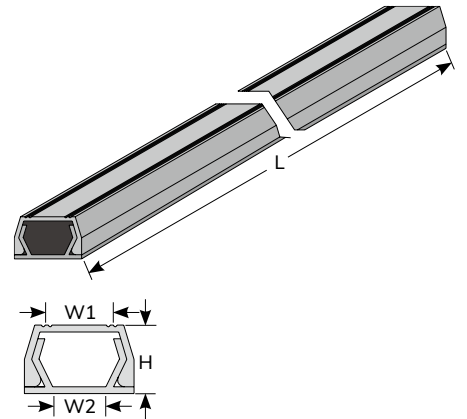

CONNECTORS TYPE :  
**MID-WAY CONNECTOR** : JDM-1    **"L" TYPE** : JDL-1  
**OUTSIDE CORNER** : JDO-1    **INSIDE CORNER** : JDI-1  
**"T" TYPE** : JDT-1

Item No.	Color	W1	W2	H1	L	Connector	Standard Color
		mm	mm	mm			
JD-1	Grey	10.4	8.6	8.0	1M With Adhesive Tape	JDT-1,JDM-1 JDI-1,JDO-1 JDL-1,JDE-1	Grey For Color add Code MW:Milk WE:White BN:Brown DB:Dark Brown
JD-1BN	Brown						
JD-1WE	White						
JD-1MW	Milk						
JD-2	Grey	14.5	11.5	8.0		JDT-2,JDM-2 JDI-2,JDO-2 JDL-2,JDE-2	
JD-2BN	Brown						
JD-2WE	White						
JD-2MW	Milk						
JD-3	Grey	18.8	16.4	10.8		JDT-3,JDM-3 JDI-3,JDO-3 JDL-3,JDE-3	
JD-3BN	Brown						
JD-3WE	White						
JD-3MW	Milk						
JD-4	Grey	23.5	19.5	12.2		JDT-4,JDM-4 JDI-4,JDO-4 JDL-4,JDE-4	
JD-4BN	Brown						
JD-4WE	White						
JD-4MW	Milk						

The above color cards are for reference only.

# 0119 KSS ADHESIVE TAPE



- Duct tape with high-performance adhesive to secure surface installation.
- Designed to meet all industry demands and applications.



Item No.	Width	Packing
	mm	
DT-8	8	100M
DT-12	12	
DT-14	14	
DT-18	18	
DT-23	23	

# 0119 KSS DOUBLE-COATED FOAM TAPE



- Duct tape with high-performance adhesive to secure surface installation.
- Designed to meet all industry demands and applications.



Item No.	Width	Packing
	mm	
DF-8	8	50M
DF-13	13	
DF-18	18	
DF-23	23	
DF-28	28	30M



## 0120 KSS U TYPE WIRING DUCT

RoHS

- Material: Transparent PVC
- Application: Peel off the adhesive tape and stick to clean, oil-free surface. Snap wire into the duct with fingertip pressure.

Item No.	W	W1	H	H1	Length
	mm	mm	mm	mm	
TD-1	8.2	6.6	5.0	4.2	2M with adhesive tape

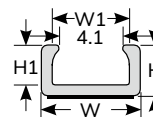

Wiring  
Ducts

Cable  
Markers

Cable  
Ties

Wrapping  
Bands

## 0121 KSS ROUND INSULATING CONDUIT

94V-0 RoHS

- Material: UL94V-0 and M1 flame rated, UL approved PVC.
- Color : Ivory
- PVC service temperature: 85°C

Item No.	ID	OD	Length
	mm	mm	
OD-16SIY	14.0	16	2M
OD-20SIY	17.6	20	
OD-20IY	16.2	20	
OD-25SIY	22.4	25	
OD-25IY	21.0	25	
OD-32SIY	29.0	32	
OD-40SIY	36.4	40	

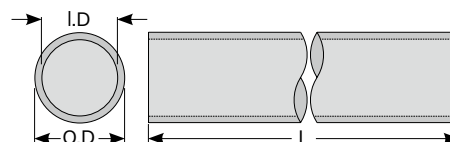

Cable Clamps  
& Tie Mounts

Glands,  
Bushings

Conduits

Bushings

Wire  
Connectors

## 0122 KSS OVAL INSULATING CONDUIT

94V-0 RoHS

- Material: UL94V-0 and M1 flame rated, UL approved PVC.
- Color : Ivory
- PVC service temperature: 85°C

Item No.	W	H	Length
	mm	mm	
OV-13IY	11.0	5.9	2M
OV-16IY	14.9	7.9	
OV-20IY	20.6	9.8	
OV-25IY	25.2	11.8	

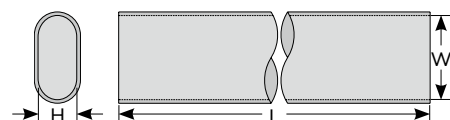

Tubes

Cable  
Clips

PCB  
Parts

Fasteners

# 0124 KSS WIRING DUCT

- Material: **UL94V-0** and **M1** flame rated, UL approved PVC.
- Color : Grey
- PVC service temperature: 85°C
- Snap the design lock into the stand aluminum frame.
- For containing wire inside professionally.



Item No.	A	B	C	D	Length
	mm	mm	mm	mm	
EX-1	10.9	20.4	21.6	28.2	2M
EX-2	5.0	14.4	9.5	16.6	

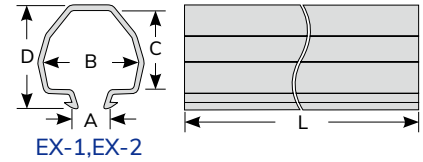
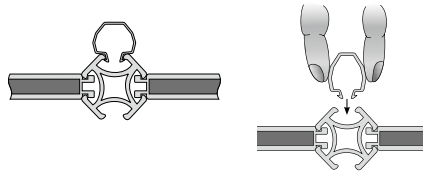

Wiring Ducts

Cable Markers

Cable Ties

Wrapping Bands

Cable Clamps & Tie Mounts

# 0124 KSS CABLE CLIP

- Material :PE
- Applied on alum pole of exhibition. EX-8 to fix cable and EX-9 to fix poster or used as hook.



Item No.	A	B	C	D	Packing
	mm	mm	mm	mm	
EX-8	15.1	6.0	16.8	23.0	100pcs
EX-9	13.0	5.0	15.0	21.5	

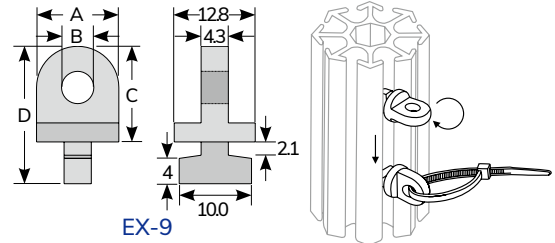
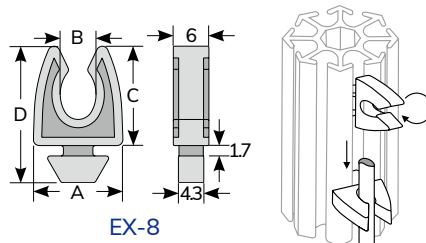

Glands, Bushings

Conduits

Bushings

Wire Connectors

Tubes

Cable Clips

PCB Parts

Fasteners

# 0125 KSS ROUND TYPE WIRING DUCT



- Material: **UL94V-0** and **M1** flame rated, UL approved PVC.
- Color: Grey. (Brown, Milk, Light Grained, Dark Grained available on request)
- PVC service temperature: 85°C
- Backed with high quality double sided tape for permanent stick. Good for floor wiring to facilitate trolley pass and to avoid trips.
- Special grooves design to avoid slips. Shining cover facilitate for decoration and suitable for department store, supermarket, shopping mall, station, hotel, hospital, office and any other public area.

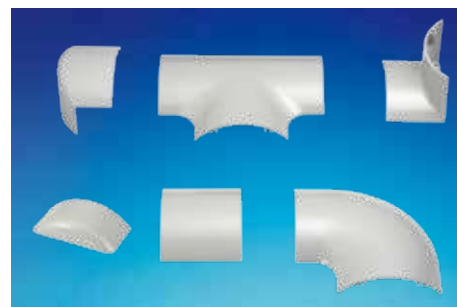

CONNECTOR COVER



CONNECTOR BASE

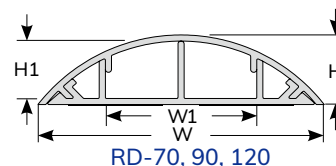
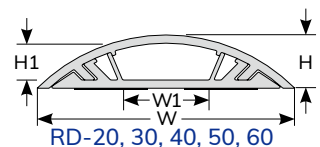

CONNECTOR COVER TYPE :	
MID-WAY CONNECTOR	: RDM-20
"L" TYPE	: RDL-20
OUTSIDE CORNER	: RDO-20
INSIDE CORNER	: RDI-20
"T" TYPE	: RDT-20
END PIECE	: RDE-20

CONNECTOR BASE TYPE :	
"L" TYPE	: RBL-60
"T" TYPE	: RBT-60



OLD TYPE



NEW TYPE

Item No.	Color	W	W1	H	H1	L	Connector lid Item No.	Connector base Item No.
		mm	mm	mm	mm	mm		
RD-20	Grey	20	8	6.0	4	1M With Adhesive Tape	RDT-20,RDM-20	RBL-20 RBT-20
RD-20BN	Brown							
RD-20MW	Milk							
RD-20LX	Light Grained							
RD-20DX	Dark Grained							
RD-30	Grey	30	11	8.0	6		RDT-30,RDM-30	RBL-30 RBT-30
RD-30BN	Brown							
RD-30MW	Milk							
RD-30LX	Light Grained							
RD-30DX	Dark Grained							
RD-40	Grey	40	16	9.5	7		RDT-40,RDM-40	RBL-40 RBT-40
RD-40BN	Brown							
RD-40MW	Milk							
RD-40LX	Light Grained							
RD-40DX	Dark Grained							
RD-50	Grey	50	20	11.0	8		RDT-50,RDM-50	RBL-50 RBT-50
RD-50BN	Brown							
RD-50MW	Milk							
RD-50LX	Light Grained							
RD-50DX	Dark Grained							
RD-60	Grey	60	30	13.0	9	RDT-60,RDM-60	RBL-60 RBT-60	
RD-60BN	Brown							
RD-60MW	Milk							
RD-60LX	Light Grained							
RD-60DX	Dark Grained							
RD-70	Grey	70	40	15.0	10	RDT-70,RDM-70	RBL-70 RBT-70	
RD-70BN	Brown							
RD-70MW	Milk							
RD-70LX	Light Grained							
RD-70DX	Dark Grained							
RD-90	Grey	90	45	19.0	15	RDT-90,RDM-90	RBL-90 RBT-90	
RD-90BN	Brown							
RD-90MW	Milk							
RD-90LX	Light Grained							
RD-90DX	Dark Grained							
RD-120	Grey	120	70	25.0	21	RDT-120,RDM-120	RBL-120 RBT-120	
RD-120BN	Brown							
RD-120MW	Milk							
RD-120LX	Light Grained							
RD-120DX	Dark Grained							

■ The above color cards are for reference only.

# 0126 KSS ROUND TYPE WIRING DUCT

- Material: **UL94V-0** and **M1** flame rated, UL approved PVC.
- Color: Grey. (Brown, Milk available)
- PVC service temperature: 85°C
- Backed with high quality double sided tape for permanent stick. Good for floor wiring to facilitate trolley pass and to avoid trips.

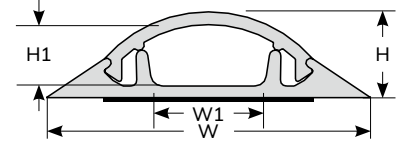
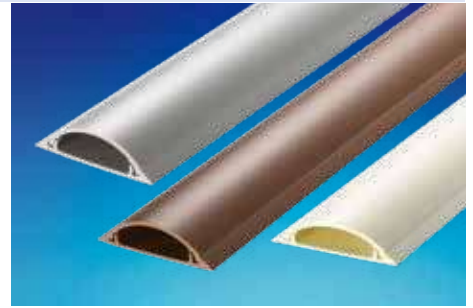

Item No.	Color	W	W1	H	H1	Length
		mm	mm	mm	mm	
RDA-30	Grey	28.8	11.0	7.4	5.2	1M With Adhesive Tape
RDA-30BN	Brown					
RDA-30MW	Milk					
RDA-40	Grey	38.5	18.8	11.5	8.5	
RDA-40BN	Brown					
RDA-40MW	Milk					
RDA-50	Grey	50.0	23.3	12.3	8.8	
RDA-50BN	Brown					
RDA-50MW	Milk					
RDA-60	Grey	60.0	33.3	13.8	10.7	
RDA-60BN	Brown					
RDA-60MW	Milk					
RDA-70	Grey	70.0	44.0	17.0	13.0	
RDA-70BN	Brown					
RDA-70MW	Milk					
RDA-90	Grey	87.5	57.5	21.0	16.5	
RDA-90BN	Brown					
RDA-90MW	Milk					
RDA-120	Grey	118.5	85.5	30.0	26.5	
RDA-120BN	Brown					
RDA-120MW	Milk					

※ This product has similar function with 0125 RD-duct except for some difference in outlook appearance.

■ The above color cards are for reference only.

# 0130 KSS SOFT SPLIT- INSERT WIRING DUCT

- Material: The wiring duct base is rigid PVC, and the two sides are flexible PVC.
- Hard base extruded PVC supplied with double sided adhesive base.
- Split insert design of duct body (soft) for easy insertion and removal of wire application.
- Suitable for wire dia. under 10mm.



Item No.	Color	W	W1	H	H1	Length
		mm	mm	mm	mm	
RSD-8WE	White	12	8.0	10.8	7.0	1M With Adhesive Tape
RSD-10BN	Brown	15	10.5	13.8	9.8	

■ The above color cards are for reference only.

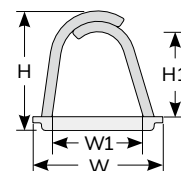

# 0127 KSS ROUND TYPE WIRING DUCT WITH ALUMINUM COVER

- Material : **UL94V-0** and **M1** flame rated, UL approved PVC with Aluminum alloy cover.
- PVC service temperature: 85°C
- Construct : Set of cover and base, self-adhesive tape backed on base for easy installation.
- Function : Suitable for telecommunication, networking, security system, computer system, monitor and other wiring application.
- Feature :
  - 1.High-impact aluminum cover to protect network communication from disconnection due to strong collision.
  - 2.Firm round cover design suitable for floor wiring application to facilitate trolley pass and avoid trips.
  - 3.Special streak design cover to avoid slip. Shining cover facilitate for decoration and suitable for department store, supermarket, shopping mall, station, hotel, hospital, office and any other public area.

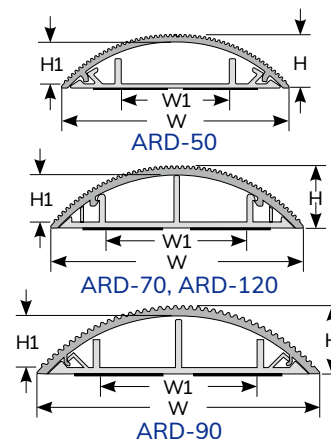

Item No.	W	W1	H	H1	Length
	mm	mm	mm	mm	
ARD-50	51.0	19.5	12.6	9.8	1M with adhesive tape
ARD-70	68.6	37.0	17.5	14.5	
ARD-90	88.0	45.0	17.7	14.5	
ARD-120	117.0	68.0	23.4	19.3	

# 0131 KSS COVERING DUCT

- Material: **UL94V-0** and **M1** flame rated, UL approved PVC.
- Color: Yellow.
- PVC service temperature: 85°C
- Function : Put wires inside the duct and fix the duct on the floor or wall.
- Feature : Can install wires before duct application. To protect wires from damage.



Item No.	W	W1	H	H1	Length
	mm	mm	mm	mm	
CD-3820YW1	67.2	38	22.3	19.8	1.2M

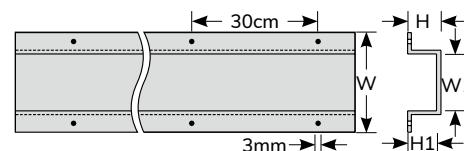

# 0128 KSS SOFT WIRING DUCT

- Material: Flexible PVC.
- Color: Grey. (Brown, Milk, Black available)
- Flexible pvc products, packed in roll for easy storage.
- Cut to required length for temporary wiring or permanent application. With adhesive tape, cloth adhesive and foam adhesive are available.

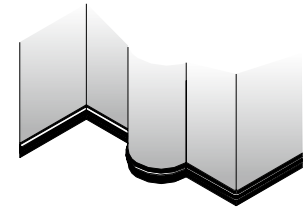
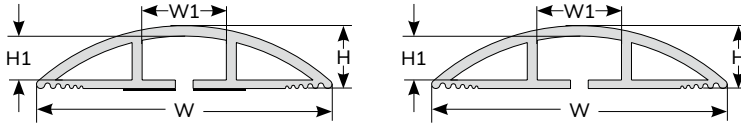

Item No.		Color	W	W1	H	H1
1M With Adhesive Tape	6 Feet (183 cm) Supplied With Adhesive Tape		mm	mm	mm	mm
SRD-251	SRD-25	Grey	25.4	7.4	5.8	3.8
SRD-251BN	SRD-25BN	Brown				
SRD-251MW	SRD-25MW	Milk				
SRD-251BK	SRD-25BK	Black				
SRD-501	SRD-50	Grey	50.8	14.8	11.6	7.8
SRD-501BN	SRD-50BN	Brown				
SRD-501MW	SRD-50MW	Milk				
SRD-501BK	SRD-50BK	Black				
SRD-651	SRD-65	Grey	66.0	19.0	15.3	10.9
SRD-651BN	SRD-65BN	Brown				
SRD-651MW	SRD-65MW	Milk				
SRD-651BK	SRD-65BK	Black				
SRD-751	SRD-75	Grey	76.2	22.0	17.4	11.6
SRD-751BN	SRD-75BN	Brown				
SRD-751MW	SRD-75MW	Milk				
SRD-751BK	SRD-75BK	Black				
SRD-1001	SRD-100	Grey	101.6	29.4	23.2	15.4
SRD-1001BN	SRD-100BN	Brown				
SRD-1001MW	SRD-100MW	Milk				
SRD-1001BK	SRD-100BK	Black				

■ The above color cards are for reference only.

# 0132 KSS MODULAR CABLE HOLDER



NEW

- Material : UL94HB flame rated, UL approved ABS.
  - Color : Black(BK), White(WE), Brown(BN), Yellow(YW), Blue(BE), Silver(SL) .
  - Application :
    - 1.It can be used for sorting out wires in the office, exhibition,store, house, etc.
    - 2.Assemble the clips before pushing the wires in through the split opening.
  - Feature :
    - 1.Adjust length and flex easily without tool.
    - 2.Split opening contributes to the installation and exchange of wires.
    3. Reusable and help heat dissipation of wires and keep wires in order.
- ※ The length is about 55cm after assembling 15 pieces in this pack.

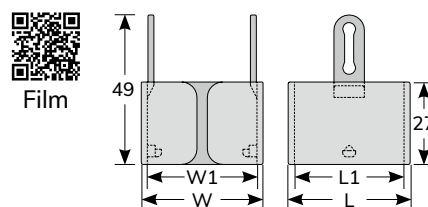

Item No.	Color	W mm	W1 mm	L mm	L1 mm	Packing
DB15MCC31WE	White					
DB15MCC31BN	Brown					
DB15MCC31YW	Yellow					
DB15MCC31BE	Blue					
DB15MCC31SL	Silver	40	36	40	36.5	
DB15MCC36BK	Black					
DB15MCC36WE	White					
DB15MCC36BN	Brown					
DB15MCC36YW	Yellow					
DB15MCC36BE	Blue					
DB15MCC36SL	Silver					

■ The above color cards are for reference only.

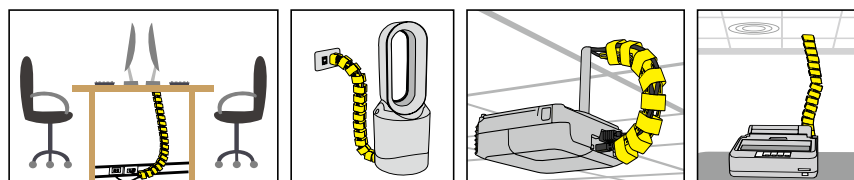

# 0133 KSS ONE PIECE WIRING DUCT



- Material: **UL94V-0** and **M1** flame rated, UL approved PVC.
- Color : White.
- PVC service temperature: 85°C
- Feature: One piece design to facilitate application and time saving.

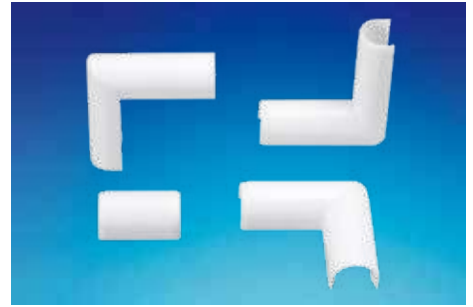

Item No.	W	W1	H	H1	Length mm	Connector	Connector Packing
	mm	mm	mm	mm			
RTF-10WE	13.1	11.6	10.8	8.2	1.5M With Adhesive Tape	L TYPE : RTFL-10WE INSIDE : RTFI-10WE OUTSIDE : RTFO-10WE MID-WAY : RTFM-10WE	20pcs

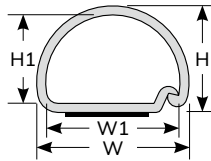

# 0140 KSS MOSAIC TRUNKING



- Material: **UL94V-0** and **M1** flame rated, UL approved PVC.
- Color : White.
- PVC service temperature: 85°C
- Feature: Mosaic design to mount switch/socket 45x45mm direct onto duct, hollow wall design.

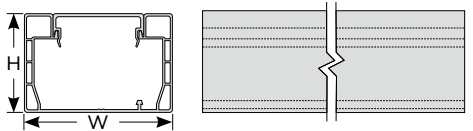

Item No.	W	H	Length
	mm	mm	
DX-7550WE	75	50	2M

# 0140 KSS MOSAIC TRUNKING CONNECTOR



- Material: **UL94HB** flame rated, UL approved ABS.
- Function: Apply with DX type mosaic trunking to connect trunkings easy and neatly.

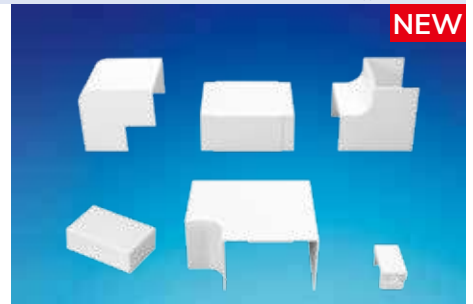

Type		Item No.	Used With	Packing
	MID-WAY CONNECTOR	DXM-7550WE2	DX-7550WE	5pcs
	INSIDE CORNER	DXI-7550WE2	DX-7550WE	
	OUTSIDE CORNER	DXO-7550WE2	DX-7550WE	

Type		Item No.	Used With	Packing
	"L" TYPE	DXL-7550WE2	DX-7550WE	5pcs
	END PIECE	DXE-7550WE2	DX-7550WE	
	COVER JOINT	DXJ-7550WE2	DX-7550WE	



# Cable Markers

Wiring  
Ducts

**Cable  
Markers**

Cable  
Ties

Wrapping  
Bands

Cable Clamps  
& Tie Mounts

Glands,  
Bushings

Conduits

Bushings

Wire  
Connectors

Tubes

Cable  
Clips

PCB  
Parts

Fasteners

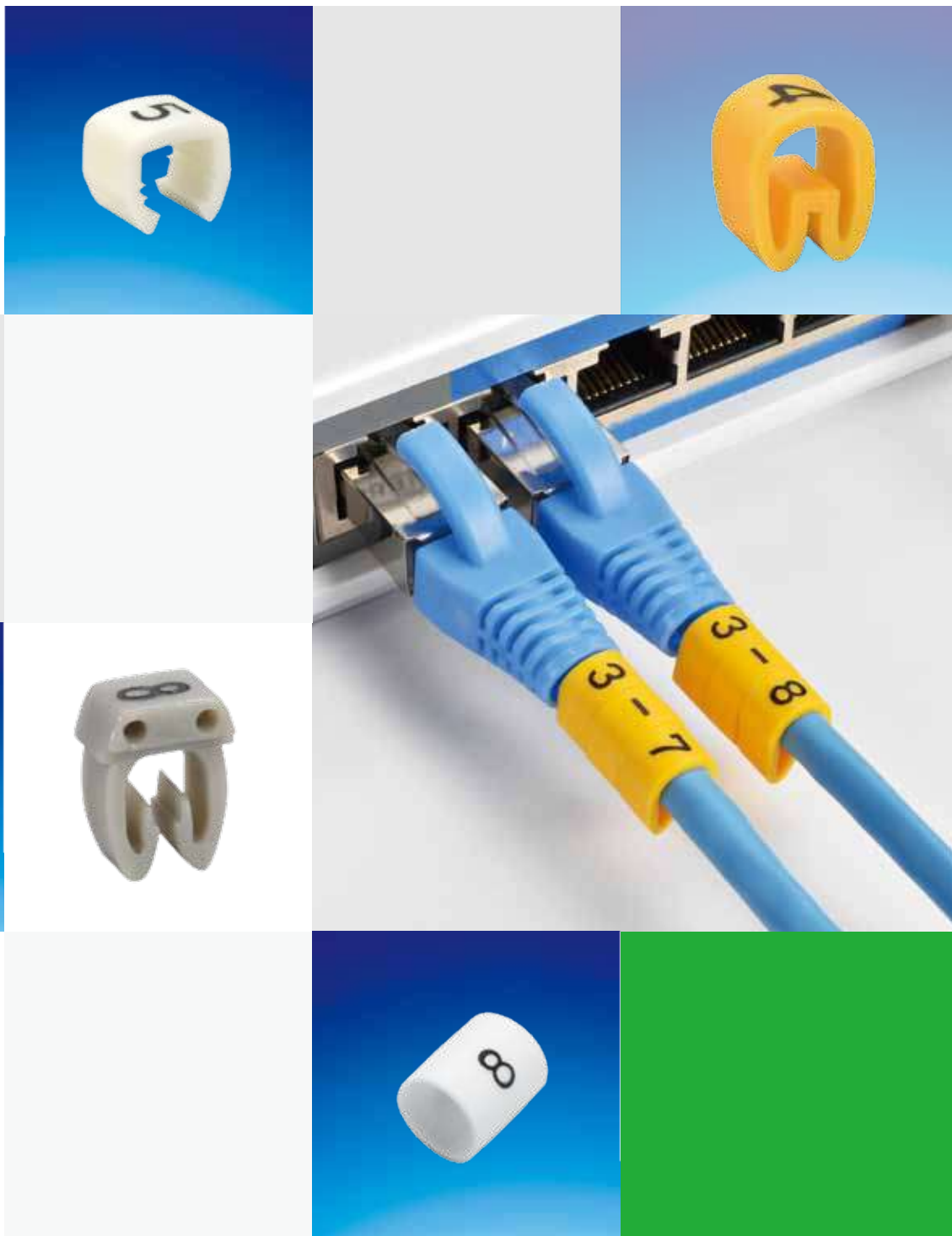

## Technical Data

### To pick the right cable marker

Cable marker will help organizing cables systematically. KSS provides several options on markers: slide on type, clip on type, sticker type, and plate type.

	Product Category	Description	Item No.
slide on		For wire w/o wire connector attached	EC, ECA, ECP, FM, OM, OMR, OMK, OMJ, OMT, FMR
clip on		For wire with wire connector attached	OC, MB, UM, SM
sticker		Apply marker sticker on cable directly	WM, WMB
plate		Could be use on cable all sizes with suitable cable tie.	MS, MT, MC

### Advantage of KSS cable marker

With clear marking, water proof and durable.  
No odor. No PFOS, PFOA, VOCs toxicant.  
Various options in size and color.

## 0201 KSS EC TYPE CABLE MARKER

● Material: Flexible PVC.

● Description:

1. KSS EC type cable marker features high quality flexible interior to fit various cable diameters.
2. The half cut marker packed on a roller and can be despatched easily when needed.
3. Bold print on yellow body to show your codes distinguishly. Any numbers can be composed by arranging letters and numbers in sequence to provide the necessary codes.
4. To be fitted before the terminal is attached or solder connection made and grip cable firmly in position.

Shape	Item No.	Suitable Wire		Suitable Range I.D.	L	Std. Markings	Packing
		sq	AWG	mm	mm		
Plain Cut	EC-0	0.12~0.75	26~18	2.0~3.2	4.0	Solid number or letter roll for 0~9, A~Z, /, +, -, =, blank ※a~z available as special request	1000pcs / Roll
	EC-1	0.75~3.5	18~12	3.0~4.2			1000pcs / Roll
	EC-2	3.5~8	12~8	3.6~7.4	5.0		500pcs / Roll
	EC-3	8~22	8~4	5.2~10.0	5.5		250pcs / Roll
Chevron Cut	ECA-02	0.12~0.75	26~18	2.0~3.2	4.0	Solid number or letter roll for 0~9, A~Z, /, +, -, =, blank ※a~z available as special request	1000pcs / Roll
	ECA-1	0.75~3.5	18~12	3.0~4.2			1000pcs / Roll
	ECA-2	3.5~8	12~8	3.6~7.4	5.0		500pcs / Roll
	ECA-3	8~22	8~4	5.2~10.0	5.5		250pcs / Roll

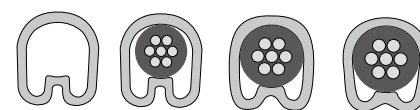

Marker tongue spans to fit various cable diameters and retracts to hold wires firmly in position.

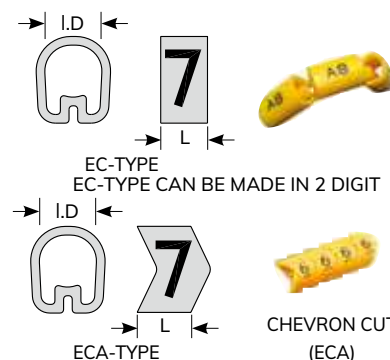

## 0201 KSS ECP TYPE CABLE MARKER

● Material : Flexible PVC.

● Description :

1. KSS ECP type cable marker features high quality flexible interior to fit various cable diameters.
2. The half cut marker packed on a roller and can be despatched easily when needed.
3. Bold print on yellow body to show your codes distinguishly. Any numbers can be composed by arranging letters and numbers in sequence to provide the necessary codes.
4. Chevron cut design to keep marking in line consistently.

Shape	Item No.	Suitable Wire		Suitable Range I.D.	L	Std. Markings	Packing
		sq	AWG	mm	mm		
Chevron Cut	ECP-02	0.2~1.25	24~16	1.3~3.0	3.0	Solid number or letter roll for 0~9, A~Z, /, +, -, =, blank	1000pcs / Roll
	ECP-1	0.5~5.5	20~10	2.5~5.1	3.0		1000pcs / Roll
	ECP-2	2.0~14.0	14~6	3.6~7.6	4.0		250pcs / Roll
	ECP-3	8.0~60.0	8~1/0	6.2~16.0	6.0		100pcs / Bag

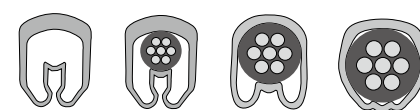

Marker tongue spans to fit various cable diameters and retracts to hold wires firmly in position.

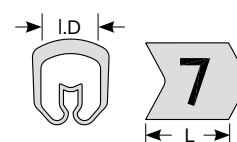

# 0201 KSS COLOR CODED CABLE MARKER

● Ordering Information: Add color code to the original Size & No.



● For Example : EC1- 0 BK

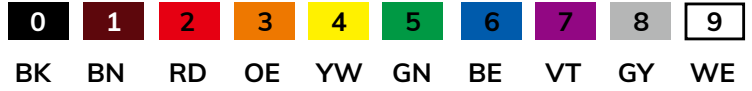
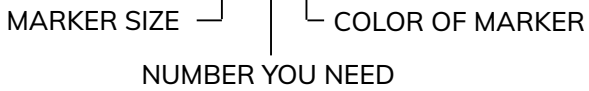

Marker Size	Item No. Color Coded	Marker Size	Item No. Color Coded	Marker Size	Item No. Color Coded	Marker Size	Item No. Color Coded	Marker Size	Item No. Color Coded
EC-0	EC0-0BK	EC-1	EC1-0BK	EC-2	EC2-0BK	EC-3	EC3-0BK	FM-1	FM1-0BK
	EC0-1BN		EC1-1BN		EC2-1BN		EC3-1BN		FM1-1BN
	EC0-2RD		EC1-2RD		EC2-2RD		EC3-2RD		FM1-2RD
	EC0-3OE		EC1-3OE		EC2-3OE		EC3-3OE		FM1-3OE
	EC0-4YW		EC1-4YW		EC2-4YW		EC3-4YW		FM1-4YW
	EC0-5GN		EC1-5GN		EC2-5GN		EC3-5GN		FM1-5GN
	EC0-6BE		EC1-6BE		EC2-6BE		EC3-6BE		FM1-6BE
	EC0-7VT		EC1-7VT		EC2-7VT		EC3-7VT		FM1-7VT
	EC0-8GY		EC1-8GY		EC2-8GY		EC3-8GY		FM1-8GY
	EC0-9WE		EC1-9WE		EC2-9WE		EC3-9WE		FM1-9WE

■ The above color cards are for reference only.

## 0201A KSS MARKER BOX

● To keep and verify cable marker in rolls and improve wire application. Suitable for outside wire/application by carrying one box with various markers inside.

Item No.	Available loaded quantity of EC Cable Marker	Material
ECB-1	13 pcs	Acrylic



## 0202 KSS FLAT CABLE MARKER

● Material : Flexible PVC.  
 ● FLAT CABLE MARKER with its unique oval shape design provide  
 1.slip over cable directly (for small cable)  
 2.slip onto marker strip (for larger cable or cable bundles)

Item No.	Suitable Wire		Suitable Range	L	Std. Markings	Packing
	sq	AWG	mm	mm		
FM-1	2~8	14~8	3.5~6.0	5.0	Solid number or letter roll for 0 ~ 9 , A ~ Z , / , + , - , ± , blank	500pcs / Roll



## 0203 KSS MARKER STRIP

- Material :UL94V-2 flame rated, UL approved Nylon 66.
- Color: Black
- Nylon 66 plate with cable tie fastening hole to accommodate marker pieces for easy identification of cable runs.

Item No.	L	W	T	Available loaded quantity of FM-1 Cable Marker	Packing
	mm	mm	mm		
MS-65	66	9	6.7	9 pcs	100pcs
MS-100	100	9	6.95	16 pcs	
MS-135	135	9	7	23 pcs	
MS-135L	135	9	13	21 pcs	
MS-170	170	9	7	30 pcs	

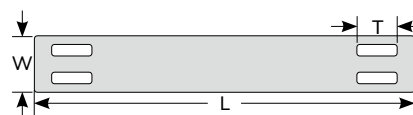
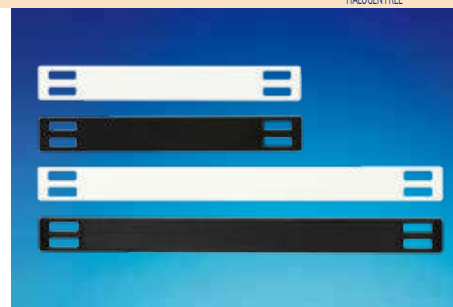

## 0205 KSS O TYPE CABLE MARKER

- Material :Flexible PVC.
- Color: White.
- Sleeve on design.
- Apply before wire termination.
- ◆ Special marking is available upon request.

- AC-110     L OUT     AUDIO IN     VIDEO OUT  
 DC-12     123     567-80     KSS-1

Item No.	Suitable Wire		I.D.	L	Std. Markings	Packing
	sq	AWG	mm	mm		
OM-22S			1.3	10	Special specification is available upon request	100pcs
OM-20S			1.5			
OM-18S			1.8			
OM-16S			1.9			
OM-0.75	0.75	18	3.0		0 ~ 100 , A ~ Z /,+, -, ⊕, blank	
OM-1.25	1.25	16	3.2			
OM-2.0	2.0	14	3.6			
OM-3.5	3.5	12	4.2			
OM-5.5	5.5	10	5.1			
OM-8	8.0	8	6.2			
OM-14	14.0	6	7.6	0 ~ 9 , A ~ Z /,+, -, ⊕, blank		
OM-22	22.0	4	9.4			

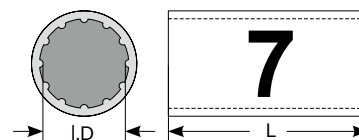

# 0207 KSS O TYPE MARKER TUBE

- Material :Flexible PVC.
- Color: White.
- Feature : Air filled tubing with 12 rifling lines inside the tube helps keep it shape and is not easily twisted. Suitable for various typing machines.



OMR Small Spool Pack



OMR Large Spool Pack

Item No.	Packing	Item No.	Packing	Suitable Wire		Wire Dia. I.D.	
				sq	AWG	mm	
OMR-0.75	100M	Small Spool Pack	OMR-0.75-10M	10M	0.75	18	3.0
OMR-1.25	100M		OMR-1.25-10M	10M	1.25	16	3.2
OMR-2.0	100M		OMR-2.0-10M	10M	2.0	14	3.6
OMR-3.5	100M		OMR-3.5-10M	10M	3.5	12	4.2
OMR-5.5	100M		OMR-5.5-10M	10M	5.5	10	5.1
OMR-8	50M		OMR-8-10M	10M	8.0	8	6.2
NEW OMR-8L	50M		OMR-8L-10M	10M	Cat.6A		7.2

Item No.	Suitable Wire		Wire Dia. I.D.	Packing
	sq	AWG	mm	
OMR-0.75-500M	0.75	18	3.0	500M
OMR-1.25-550M	1.25	16	3.2	550M
OMR-2.0-500M	2.0	14	3.6	500M
OMR-3.5-400M	3.5	12	4.2	400M
OMR-5.5-200M	5.5	10	5.1	200M

- Material :Flexible PVC.
- Color: White.
- Feature : 1. Air filled tubing with 12 rifling lines inside the tube helps keep it shape and is not easily twisted. Suitable for various typing machines.  
2.Packed in box to keep tube clean for printing. Good storage with 1000M per box.



OMK

Item No.	Suitable Wire		Wire Dia. I.D.	Packing
	sq	AWG	mm	
OMK-0.75	0.75	18	3.0	1000M / Box
OMK-1.25	1.25	16	3.2	
OMK-2.0	2.0	14	3.6	

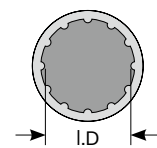
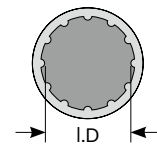

## 0207 KSS O TYPE MARKER TUBE

- Material: Flexible PVC
- Color: White.
- OMT Feature : Air filled tubing with smooth design, good for various printing machines.
- OMT-6.2 suitable for Cat.5e \ Cat.6 wires.  
OMT-7.1 suitable for Cat.6A wires.

Item No.	Suitable Wire		Wire Dia. I.D.	Packing	
	sq	AWG	mm		
OMT-2.5	0.5	20	2.5	200M / Roll	Small Spool Pack
OMT-3.0	0.75	18	3.0		
OMT-3.2	1.25	16	3.2		
OMT-3.5	2.0	14	3.5		
OMT-4.0	2.0	14	4.0		
OMT-4.5	3.5	12	4.5		
OMT-5.0	5.5	10	5.0	100M / Roll	
OMT-5.5	5.5	10	5.5		
OMT-6.2	8.0	8	6.2	50M / Roll	
OMT-6.7			6.7		
OMT-7.1	Cat.6A		7.1		
OMT-2.5-800M	0.5	20	2.5	800M / Roll	Large Spool Pack
OMT-3.0-600M	0.75	18	3.0	600M / Roll	
OMT-3.2-650M	1.25	16	3.2	650M / Roll	
OMT-3.5-550M	2.0	14	3.5	550M / Roll	
OMT-4.0-450M	2.0	14	4.0	450M / Roll	
OMT-4.5-400M	3.5	12	4.5	400M / Roll	
OMT-5.0-350M	5.5	10	5.0	350M / Roll	
OMT-5.5-250M	5.5	10	5.5	250M / Roll	

※ Bright colors available in stock, please add suffix "BS" on part no.  
e.g.OMT2.5BS : bright white OMT2.5BSYW : bright yellow

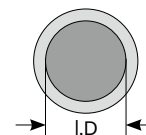

OMT Small Spool Pack



OMT Large Spool Pack

## 0208 KSS FLAT MARKER TUBE

- Material : Flexible PVC.
- Color: White.
- Feature : Flat design and good for printing machine.

Item No.	Dimension (mm)				Packing
	D	d1	I.D.	t	
FMR-3	3.65	1.75	2.0	0.35	100M / Roll
FMR-4	5.10	1.90	3.0	0.40	
FMR-6	6.70	2.80	4.2	0.50	
FMR-8	7.60	3.30	5.0	0.58	
FMR-11	10.45	3.85	6.6	0.73	
FMR-13	12.30	4.80	8.0	0.75	
FMR-18	17.10	5.60	11.0	0.80	50M / Roll

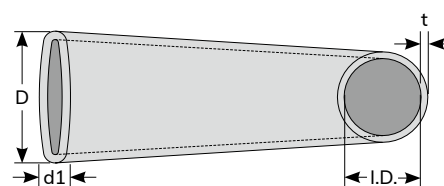
 Wiring  
Ducts

 Cable  
Markers

 Cable  
Ties

 Wrapping  
Bands

 Cable Clamps  
& Tie Mounts

 Glands,  
Bushings

Conduits

Bushings

 Wire  
Connectors

Tubes

 Cable  
Clips

 PCB  
Parts

Fasteners

# 0210 KSS MARKER PLATE

- Material : UL94V-2 flame rated, UL approved Nylon 66.
- Color : White
- Used to mark cable bundles for permanent identification.
- Secured with KSS cable ties extensively from CV-075 to CV-432 in variety of ways.
- For tie width : less than 4.8 mm

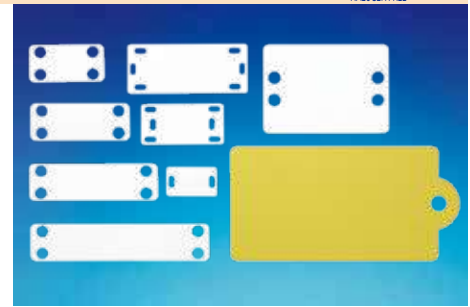

Item No.	L	W	Thickness	Packing
	mm	mm	mm	
MT-1	26.0	15.2	1.2	100pcs
MT-2	42.2	21.2	1.2	
MT-3	60.8	25.2	1.2	
MT-4	62.2	51.5	1.3	
<b>NEW</b> MT-5	75.0	55.0	1.3	
<b>NEW</b> MT-6	100.0	55.0	1.3	
MT-3819	38.5	19.1	0.4	
MT-4419	45.3	19.1	0.4	
MT-5019	50.5	19.1	0.4	
MT-6319	65.0	19.1	0.4	
MT-6344	63.8	44.8	0.4	
MT-8819	90.0	19.1	0.4	
<b>NEW</b> MT-13518	135.0	18.0	1.0	

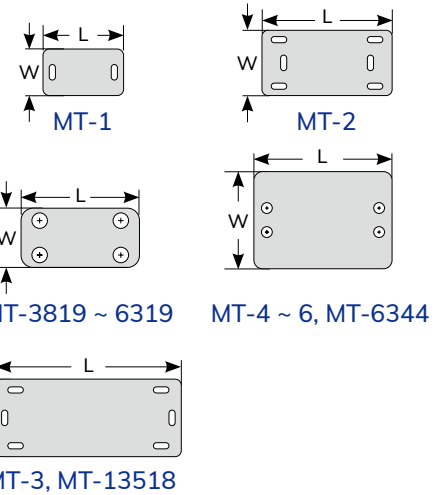

- Material : UL approved Nylon 66
- Color : Yellow (colors are available upon request).
- Used to mark cable bundles for permanent identification.
- Secured with KSS cable ties extensively from CV-075 to CV-432 in variety of ways.
- For tie width : less than 4.8 mm

Item No.	L	W	Thickness	Packing
	mm	mm	mm	
MT-16080YW	160.0	80.0	0.6	100pcs

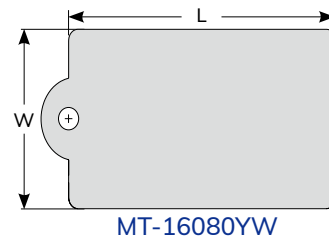

# 0212 KSS MARKER BOX

- Material : PE
- Color : Natural
- Using Method : Cut the paper in a suitable size and mark with numbers or letters you want.
- Put the paper into marker box and tie up with cable tie.
- For tie width : less than 4.8 mm



Item No.	W	L	H	W1	Marking pad	Packing
	mm	mm	mm	mm	mm	
MC-1	32.6	11.5	3.0	5.0	30×9.5	100pcs
MC-2	43.5	19.1	4.6	5.1	40×17	

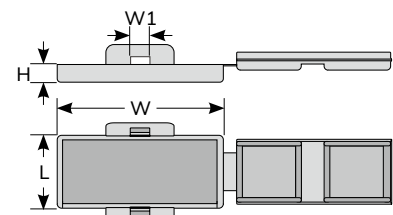



# 0215 KSS SELF ADHESIVE WIRE MARKER

- Material : Nylon taffeta with adhesive.
- Stick to wires for permanent identification.
- Used extensively for cable diameters after or before terminal is attached.
- For your orders, please specify solid or consecutive and what letter (s), number (s) you need.
- ※WMB-5 content please reference WMB-2、WMB-3、WMB-4
- ※WM-1 has 4 pieces/sheet. WMB-1, WMB-2, WMB-3, WMB-4 and WMB-5 have 7 pieces/sheet.



BOOK SIZE: L:143 W:82

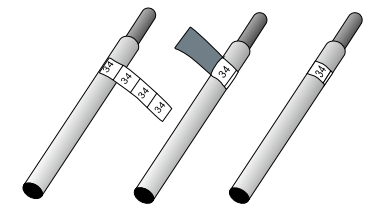

Item No.	L	W	Std. Markings	Packing
	mm	mm		
WM-1	25	6.0	Solid : 0,1,2,3,...100 A,B,C,...Z,+,-,≡ Consecutive Number : 0~9	4 pcs/Leaf , 80 Leaf/Sheet 50 Sheet/Box
		7.0	Consecutive Number : 1~34, 35~67, 68~100, A~Z	4 pcs/Leaf , 68 Leaf/Sheet 50 Sheet/Box
WM-2	25	6.5	blank	80 Leaf/Sheet
WM-3	10	40.0		30 Leaf/Sheet
WMB-1	33	5.6	0~9 @ 1 page	10 Sheet/Box 45 Leaf/Sheet
WMB-2	33	5.6	(A~Z,/,+,-,0~15) X 1 page	
WMB-3	33	5.6	(1~45) X 1 page	
WMB-4	33	5.6	(46~90) X 1 page	
WMB-5	33	5.6	(1~45) X 4 page、(46~90) X 4 page (A~Z,/,+,-,0~15) X 2 page	

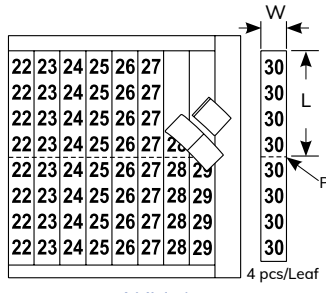

WM-1

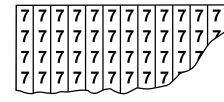

SOLID NUMBER



SOLID LETTERS

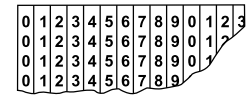

CONSECUTIVE NUMBERS(0~9)

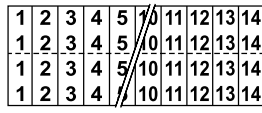

CONSECUTIVE NUMBERS (1~34)

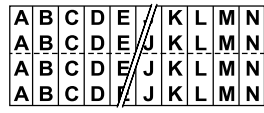

CONSECUTIVE LETTERS(A~Z)

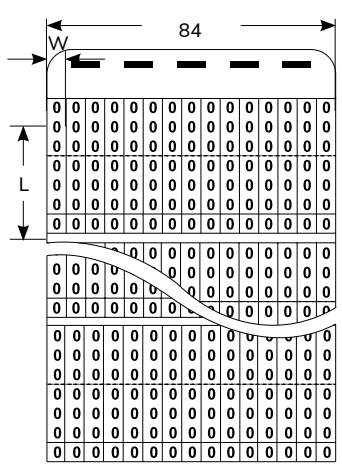

WMB-1

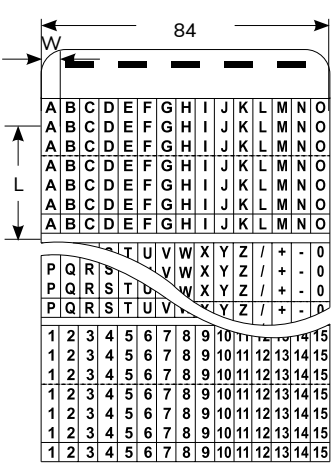

WMB-2

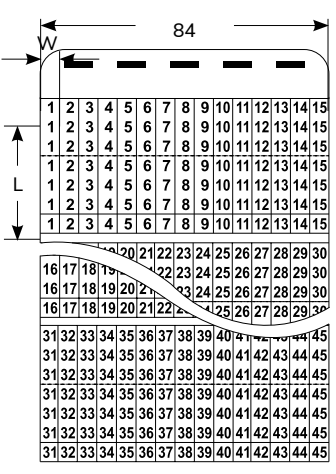

WMB-3

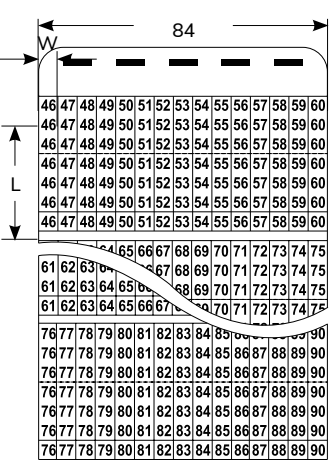

WMB-4

Wiring Ducts

Cable Markers

Cable Ties

Wrapping Bands

Cable Clamps & Tie Mounts

Glands, Bushings

Conduits

Bushings

Wire Connectors

Tubes

Cable Clips

PCB Parts

Fasteners

# 0225 KSS OC TYPE CABLE MARKER

- Material : **UL94V-0** flame rated, UL approved PVC.
- Standard color: White body marker in black.
- PVC service temperature: 85°C
- Description:
  1. To be fitted after termination. The marker can be removed without breaking the terminal connection.
  2. O shape design benefit to grip the wire/cable tight.
  3. Clip on design enable it to grip wire/cable firmly in position after termination attached.
  4. Each marker will accommodate multiple wire sizes.



※OC-2L has wider entrance.

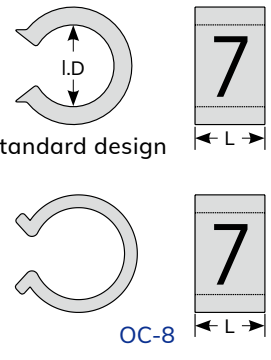

Item No.	Suitable Wire		Suitable Range mm	L mm	Std. Markings	Packing
	sq	AWG				
OC-1	0.5~0.75	20~18	2.5~3.0	4	Solid number or letter roll for 0 ~ 9, A ~ Z /, +, -, ÷, blank	1000pcs / Roll
OC-2	1.25~2.0	16~14	3.2~3.6			
※OC-2L	1.25~2.0	16~14	3.2~3.6			
OC-3	3.5~5.5	12~10	4.2~5.1			500pcs / Roll
OC-4	5.5~8.0	10~8	5.1~6.2			
OC-8	14	6	7.5~8.0	6.0	300pcs / Roll	

Wiring Ducts

Cable Markers

Cable Ties

Wrapping Bands

Cable Clamps & Tie Mounts

Glands, Bushings

Conduits

Bushings

Wire Connectors

Tubes

Cable Clips

PCB Parts

Fasteners

# 0234 KSS MB TYPE CABLE MARKER

- Material : UL94HB flame rated Nylon 6.
- Color : Yellow, White
- Features :
  1. One size MB cable marker is suitable for different cable dia.
  2. Fast, snap-on installation.
  3. Flexible design, not easy to transfigure.
  4. High quality hot-foil stamped.
  5. Special inside stop point design makes MB marker keep in same direction, not overturn, marker read easily.

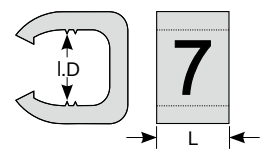

Item No.		Suitable Wire				Suitable Range I.D.	L	Std Markings	Packing
Yellow	White	sq	AWG	Fiber-optic	LAN cable	mm	mm		
MB-0	MB-0WE	0.75	18	2.0		2.2	4.0	Solid number or letter roll for 0 ~ 9, A ~ Z /, +, -, ÷, blank	100pcs
MB-1	MB-1WE	1.25~2.0	16-14	3.0		3.0~3.4			
MB-2	MB-2WE	3.5-5.5	12-10		CAT.5e	4.0~5.0			
MB-3	MB-3WE	8	8		CAT.6	5.2~6.0			
MB-4	MB-4WE				CAT.6	5.8~7.0			
MB-5	MB-5WE	14	6		CAT.6A	7.0~8.1	6.0		

## 0235 KSS U TYPE CABLE MARKER

- Material: PP
- Color: Pink(PK1), Blue(BE1), Yellow(YW1), Green(GN1),Purple(VT1).
- Different colors for easy identification.

Item No.	Suitable Wire		L mm	H mm	W mm	I.D. mm	Packing
	sq	AWG					
UM-1	1.25~2.0	16~14	12.6	4.3	4.4	3.0	100pcs

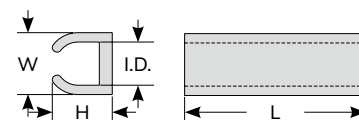

Wiring Ducts

Cable Markers

Cable Ties

Wrapping Bands

Cable Clamps &amp; Tie Mounts

Glands, Bushings

## 0236 KSS SM TYPE CABLE MARKER

- Material : UL94V-2 flame rated, UL approved Nylon 66.
- Color : Yellow
- Yellow body with black printing

Item No.	Packing	Item No.	Packing	Suitable Wire		Suitable Range I.D. mm	L mm	Std. Markings
				mm <sup>2</sup>	AWG			
SM-0	1000pcs (25pcsX40strips)	P-SM0	250pcs (25pcsX10strips)	0.12~0.5	26~20	1.2~2.0	2.3	0 ~ 9 A ~ Z /,+,- ±,blank
SM-1	1200pcs (30pcsX40strips)	P-SM1	300pcs (30pcsX10strips)	0.5~1.5	20~18	2.2~2.8	2.9	
SM-2	1200pcs (30pcsX40strips)	P-SM2	300pcs (30pcsX10strips)	1.5~2.5	16~14	3.0~3.6	2.8	
SM-3	800pcs (20pcsX40strips)	P-SM3	200pcs (20pcsX10strips)	4~6	12~10	4.2~5.1	2.9	

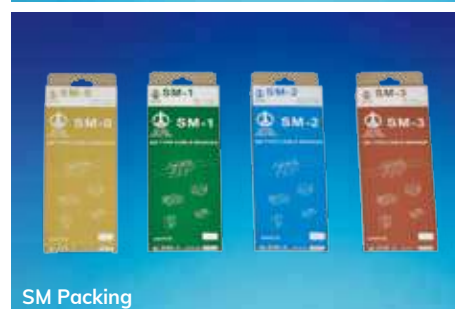
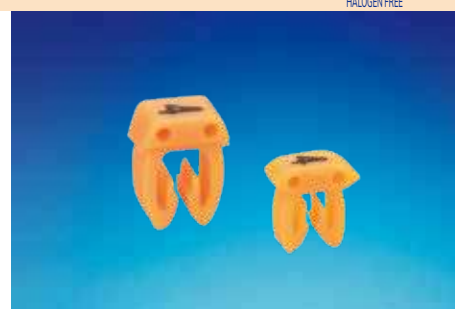

SM Packing

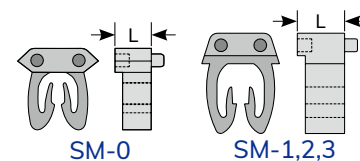

Conduits

Bushings

Wire Connectors

Tubes

Cable Clips

PCB Parts

Fasteners

# 0236 KSS SM TYPE COLOR CODED CABLE MARKER



- Material: UL94V-2 flame rated, UL approved Nylon 66.
- Feature :
  1. More effective in marker assembly. It can be applied after completing of terminal assembly to the wire.
  2. Not easy to transfigure and beautiful ,clear printing and longer lasting (not fade easily).
  3. Strip off from the cutting point easily when used. Continuously SM type cable markers is string type and each one is connected.



SM Packing



PB-SM Packing

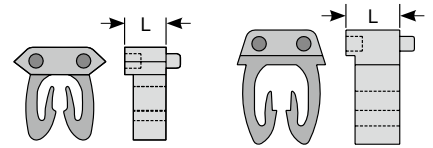

SM-0

SM-1,2,3

- Ordering Information: Add color code to the original Size & No.

- For Example : SM1- 0 BK

MARKER SIZE    NUMBER YOU NEED    COLOR OF MARKER

0	1	2	3	4	5	6	7	8	9
BK	BN6	RD	OE	YW2	GN	BEC	VT	GY	WE

Marker Size	Item No. Color Coded	Marker Size	Item No. Color Coded	Marker Size	Item No. Color Coded	Marker Size	Item No. Color Coded
SM-0	SM0-0BK	SM-1	SM1-0BK	SM-2	SM2-0BK	SM-3	SM3-0BK
	SM0-1BN6		SM1-1BN6		SM2-1BN6		SM3-1BN6
	SM0-2RD		SM1-2RD		SM2-2RD		SM3-2RD
	SM0-3OE		SM1-3OE		SM2-3OE		SM3-3OE
	SM0-4YW2		SM1-4YW2		SM2-4YW2		SM3-4YW2
	SM0-5GN		SM1-5GN		SM2-5GN		SM3-5GN
	SM0-6BEC		SM1-6BEC		SM2-6BEC		SM3-6BEC
	SM0-7VT		SM1-7VT		SM2-7VT		SM3-7VT
	SM0-8GY		SM1-8GY		SM2-8GY		SM3-8GY
SM0-9WE	SM1-9WE	SM2-9WE	SM3-9WE				

■ The above color cards are for reference only.

- Wiring Ducts
- Cable Markers
- Cable Ties
- Wrapping Bands
- Cable Clamps & Tie Mounts
- Glands, Bushings
- Conduits
- Bushings
- Wire Connectors
- Tubes
- Cable Clips
- PCB Parts
- Fasteners

# Cable Ties

Wiring  
Ducts

Cable  
Markers

**Cable  
Ties**

Wrapping  
Bands

Cable Clamps  
& Tie Mounts

Glands,  
Bushings

Conduits

Bushings

Wire  
Connectors

Tubes

Cable  
Clips

PCB  
Parts

Fasteners



# Technical Data

## How to pick a right cable tie

1. Suitable material
2. Tensile strength

3. Maximum Bundle Diameter

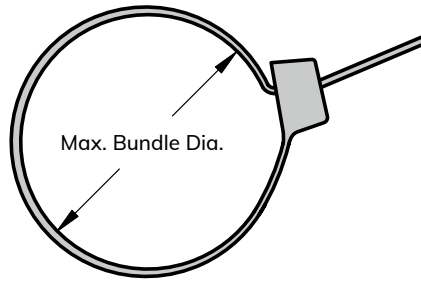

## Nylon 66 Cable tie

With excellent mechanical characteristics, durable, great impact resistance, great damping capacity, great wear resistance, low coefficient of friction.

## Loop Tensile Strength Test according to UL62275

KSS Cable Ties have been tested and certified according to UL62275. Loop Tensile Strength is the one of the most important test for cable tie. KSS Cable Ties' Loop Tensile Strength is proved by the following test:

1. Installing Cable Tie on a test mandrel as figure.
2. Applying pulling force  $25 \pm 2.5$ mm/min until the load equivalent to declared Loop Tensile Strength.
3. The load should be maintain at least 60 sec.
4. After test The Cable Tie shall not break and slippage (above 1.6mm) shall not occur.

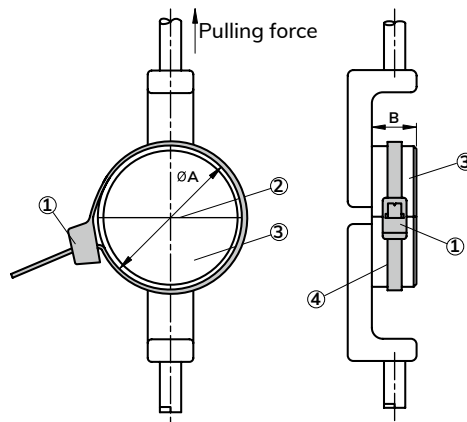

Figure1. Installation for standard cable tie

- ① Head of Cable Tie ② Split line ③ Mandrel ④ Cable tie

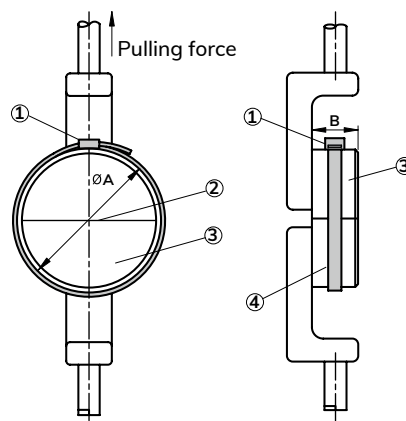
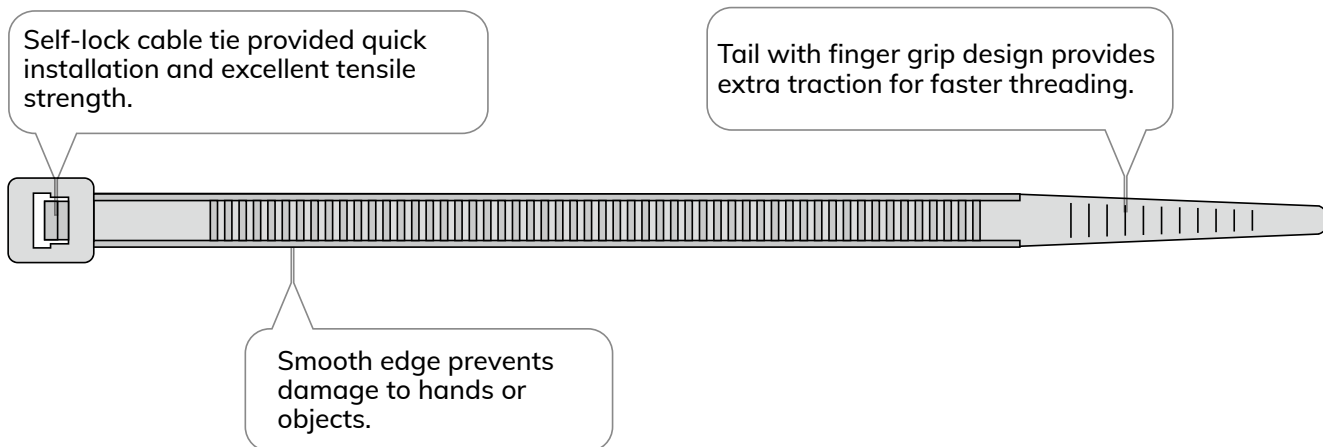

Figure2. Installation for parallel entry cable tie

- ① Head of Cable Tie ② Split line ③ Mandrel ④ Cable tie

## Technical Data

### KSS Cable tie features :



### UL181B-C (Mechanical Fasteners For Use With Flexible Air Ducts)

KSS Cable Tie is approved by UL181B-C to assure KSS Cable Tie's reliability in air ducts application.

Installation instruction of cable ties shows below:

1. Roll back outer cover and slide inner liner over air duct connector.
2. Fix inner liner with cable tie.
3. Recover the outer cover.
4. Fix outer cover with another cable tie.

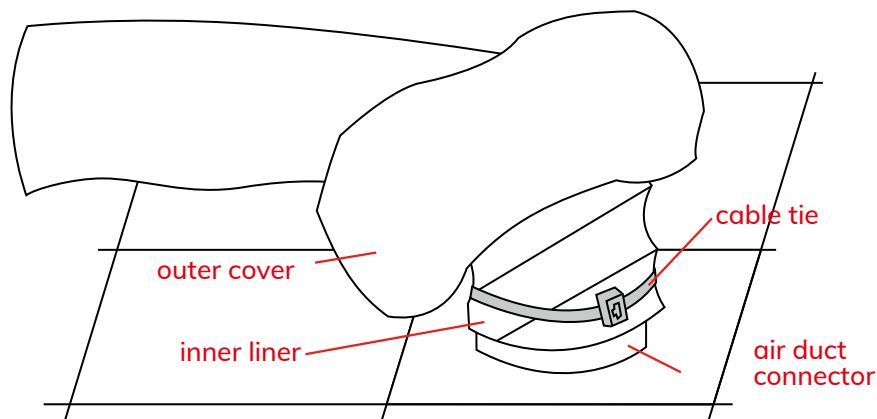

Figure1.

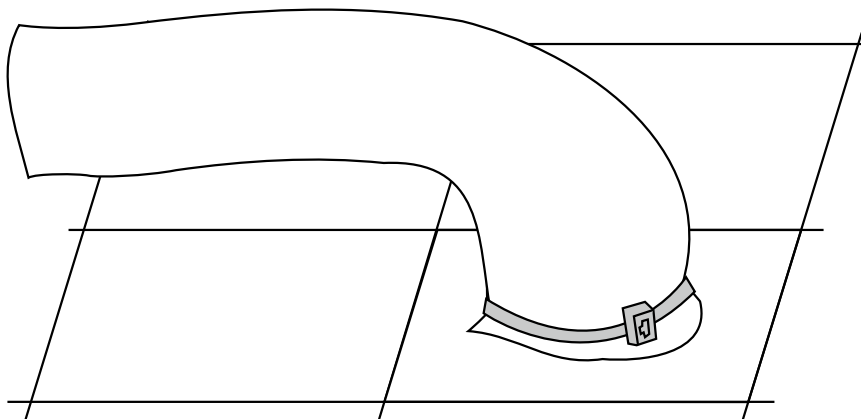

Figure2.

## Technical Data

### KSS Safety Certification :

	UL Recognized Product Marks for USA & Canada
	UL Recognized Component Marks for USA & Canada
	VDE Prüf- und Zertifizierungsinstitut
	Lloyd's Register Marine and Shipping
	Det Norske Veritas & Germanischer Lloyd
	American Bureau of Shipping
	European Conformity
	UK Conformity Assessed

### KSS Storage and Application :

KSS Cable ties are made by high quality Nylon 66 resin. The property of this material is absorb and release of moisture. Cable ties require to be contained the moisture and packed in the sealed packaging to maintain optimal performance. Hence, the conditions for keeping the packaging of cable ties are very important.

#### APPLICATION:

	The ideal storage temperature is around 23°C with the humidity over 50 %
	Do not open the bag before use. Please try to finish the whole package of cable ties shortly once it's opened. Seal the bag for remaining pieces to keep quality.
	Do not expose directly under sunlight except UV resistant cable ties.
	Avoid storing cable ties next to warm objects like heaters.



## Technical Data

### KSS cable tie is EN45545-2 certified

EN45545-2 is a safety requirement set up by EU for fire protection of railway vehicles. With complicated and massive cable system equip on railway vehicle, material performance on burning behavior, heat release rate, smoke density and toxicity is utmost important to ensure safety. For cable ties application area respectively to internal R22 and external R23, and assigning degrees of fire hazard from low to high as HL1, HL2 and HL3.



### KSS cable tie is certificated with level below:

Application Area	UV Resistant (CV-W)	Heat Stabilized (CV-HS)	Flame Retardant (CV-V0)
R22	HL2	HL2	HL1
R23	HL2	HL2	HL2

### KSS Cable Tie Standard Bag

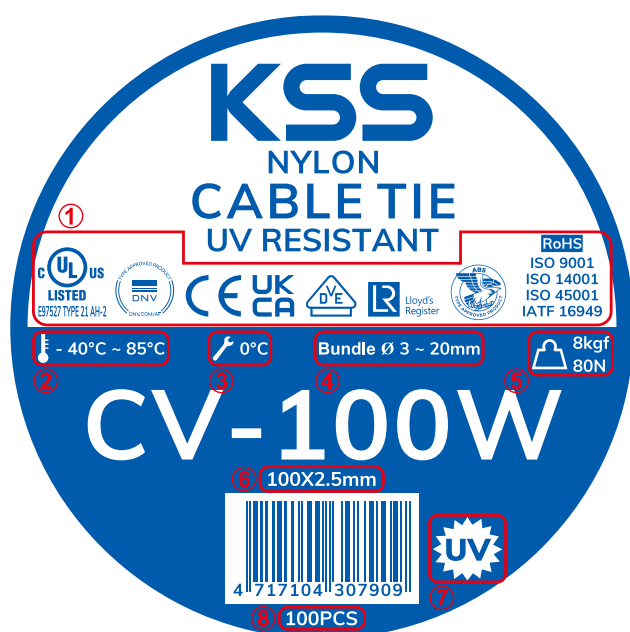

- ① Certificates- See page 247 for detail info.
- ② Operating temp.- Sustainable temp. range after installation.
- ③ Min. installation temp.- Minimum temp. when installation.
- ④ Bundle diameter range
- ⑤ Min. loop tensile strength- Test according to UL62275
- ⑥ Dimension- Length x Width
- ⑦ UV resistant
- ⑧ packing quantity

# 0301 KSS NYLON CABLE TIE



- Material: UL94V-2 flame rated, UL approved Nylon 66.
- Color: Standard color is natural, black, other special colors are available upon request.
- Feature: Low Smoke and Halogen Free cable tie suitable for various industry, also household DIY and gardening.  
Max. operating temperature up to 85°C
- Application: One piece self-lock cable tie save the time and make effective for installation.

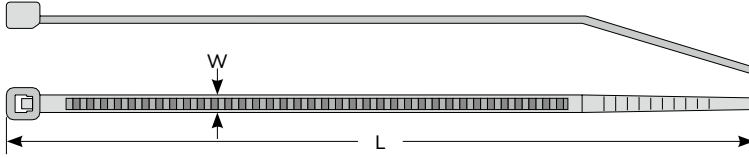

Item No.				Length		W	Max. Bundle Dia.	Min. Loop Tensile Strength		
Natural		Black		mm	inch			lbs	kgs	
100pcs	1000pcs	100pcs	1000pcs							
※CVT-070	CVT-070K	CVT-070B	CVT-070KB	71	2 13/16"	1.6	11	7	3	MINIATURE
※CVT-100	CVT-100K	CVT-100B	CVT-100KB	103	4"	1.95	22	11	5	
CV-060	CV-060K	CV-060B	CV-060KB	63.7	2 1/2"	2.4	11	18	8	
CV-075	CV-075K	CV-075B	CV-075KB	75	3"	2.4	15			
CV-080	CV-080K	CV-080B	CV-080KB	80	3 1/8"	2.5	16			
CV-094	CV-094K	CV-094B	CV-094KB	96	3 3/4"	2.5	21			
CV-100	CV-100K	CV-100B	CV-100KB	100	4"	2.5	22			
CV-120S	CV-120SK	CV-120SB	CV-120SKB	120	4 3/4"	2.5	28			
CV-140S	CV-140SK	CV-140SB	CV-140SKB	142	5 1/2"	2.5	35			
CV-150S	CV-150SK	CV-150SB	CV-150SKB	155	6 1/8"	2.5	39			
CV-165	CV-165K	CV-165B	CV-165KB	165	6 1/2"	2.5	43			
CV-200M	CV-200MK	CV-200MB	CV-200MKB	203	8"	2.5	55			
CV-250S	CV-250SK	CV-250SB	CV-250SKB	250	10"	2.5	68			
CV-300M		CV-300MB		300	11 7/8"	2.5	80			
CV-400S		CV-400SB		400	15 3/4"	2.5	116			
CV-120	CV-120K	CV-120B	CV-120KB	120	4 3/4"	3.2	27	40	18	
CV-140	CV-140K	CV-140B	CV-140KB	142	5 1/2"	3.2	34			
CV-150	CV-150K	CV-150B	CV-150KB	150	6"	3.6	36			
CV-180	CV-180K	CV-180B	CV-180KB	180	7"	3.6	46			
※CV-180T	CV-180TK	CV-180TB	CV-180TKB	180	7"	3.6	46			
CV-200S	CV-200SK	CV-200SB	CV-200SKB	203	8"	3.2	53			
CV-200A	CV-200AK	CV-200AB	CV-200AKB	203	8"	3.6	52			
CV-250M	CV-250MK	CV-250MB	CV-250MKB	250	10"	3.6	68			
CV-265	CV-265K	CV-265B	CV-265KB	265	10 1/2"	3.6	73			
CV-292	CV-292K	CV-292B	CV-292KB	292	11 1/2"	3.6	82			
CV-330		CV-330B		330	13"	3.6	93			
CV-368S		CV-368SB		368	14 1/2"	3.6	105			
CV-120L	CV-120LK	CV-120LB	CV-120LKB	120	4 3/4"	4.8	27	50	22	
CV-160L	CV-160LK	CV-160LB	CV-160LKB	160	6 1/4"	4.8	39			
CV-190	CV-190K	CV-190B	CV-190KB	190	7 1/2"	4.8	49			
※CV-190T	CV-190TK	CV-190TB	CV-190TKB	190	7 1/2"	4.8	49			
CV-200	CV-200K	CV-200B	CV-200KB	203	8"	4.6	52			
CV-200D	CV-200DK	CV-200DB	CV-200DKB	203	8"	4.8	52			

※ CVT-070 doesn't have minimum bundle diameter. ※ CV-200T Tail ※ CV-180T Tail CV-190T

# 0301 KSS NYLON CABLE TIE



Item No.				Length		W	Max. Bundle Dia.	Min. Loop Tensile Strength		
Natural		Black		mm	inch			lbs	kgs	
100pcs	1000pcs	100pcs	1000pcs							
※CV-200T	CV-200TK	CV-200TB	CV-200TKB	203	8"	4.6	52	50	22	STANDARD
CV-250	CV-250K	CV-250B	CV-250KB	250	10"	4.8	68			
CV-280	CV-280K	CV-280B	CV-280KB	280	11"	4.8	77			
CV-300S		CV-300SB		300	11 7/8"	4.8	83			
CV-310		CV-310B		310	12"	4.8	86			
CV-350		CV-350B		350	13 3/4"	4.6	98			
CV-368		CV-368B		368	14 1/2"	4.8	105			
CV-385		CV-385B		385	15 3/16"	4.8	110			
CV-400		CV-400B		400	15 3/4"	4.6	116			
CV-432		CV-432B		432	17"	4.8	125			
CV-450M		CV-450MB		450	17 3/4"	4.8	131			
CV-500		CV-500B		500	19 11/16"	4.8	147			
CV-550S		CV-550SB		550	21 11/16"	4.8	162			
CV-610S		CV-610SB		610	24"	4.8	181			
CV-635S		CV-635SB		635	25"	4.8	189			
NEW CV-730S		CV-730SB		730	28 3/4"	4.8	219			
CV-914S		CV-914SB		914	36"	4.8	278			
CV-380S		CV-380SB		380	15"	6.4	108	100	45	
CV-750		CV-750B		750	29 1/2"	7.5	223	120	55	HEAVY DUTY
CV-120LL	CV-120LLK	CV-120LLB	CV-120LLKB	120	4 3/4"	7.6	22			
CV-150L	CV-150LK	CV-150LB	CV-150LKB	150	6"	7.6	32			
CV-200L	CV-200LK	CV-200LB	CV-200LKB	203	8"	7.6	52			
CV-240L	CV-240LK	CV-240LB	CV-240LKB	240	9 7/16"	7.6	61			
CV-250L		CV-250LB		250	10"	7.6	64			
CV-280L	CV-280LK	CV-280LB	CV-280LKB	280	11"	7.6	74			
CV-300		CV-300B		300	11 7/8"	7.6	80			
CV-340		CV-340B		340	13 1/2"	7.6	92			
CV-360		CV-360B		360	14 3/16"	7.6	99			
CV-370		CV-370B		370	14 9/16"	7.6	101			
CV-380		CV-380B		380	15"	7.6	105			
CV-610M		CV-610MB		610	24"	7.6	177			
CV-380L		CV-380LB		380	15"	8.0	105			
CV-450		CV-450B		450	17 3/4"	8.0	128			
CV-500L		CV-500LB		500	19 11/16"	8.0	143			
CV-550		CV-550B		550	21 11/16"	8.0	160			
CV-450L		CV-450LB		450	17 3/4"	9.0	128			
CV-550D		CV-550DB		550	21 11/16"	9.0	160			
CV-610		CV-610B		610	24"	9.0	177			
CV-685		CV-685B		685	27"	9.0	202			
CV-710		CV-710B		710	28"	9.0	209			
CV-762		CV-762B		762	30"	9.0	227			
CV-812		CV-812B		812	32"	9.0	243			
CV-914		CV-914B		914	36"	9.0	275			
CV-940		CV-940B		940	37"	9.0	284			
CV-1168		CV-1168B		1168	46"	9.0	356			
CV-1219		CV-1219B		1219	48"	9.0	372			
CV-1500		CV-1500B		1500	59"	9.0	462			
CV-550L		CV-550LB		550	21 11/16"	12.7	159	250	114	

- Wiring Ducts
- Cable Markers
- Cable Ties
- Wrapping Bands
- Cable Clamps & Tie Mounts
- Glands, Bushings
- Conduits
- Bushings
- Wire Connectors
- Tubes
- Cable Clips
- PCB Parts
- Fasteners

# 0301 KSS SUPER STRENGTH NYLON CABLE TIE



- Material: UL94V-2 flame rated, UL approved Nylon 66.
- Color: Standard color is natural, black, other special colors are available upon request.
- Feature: Low Smoke and Halogen Free cable tie suitable for various industry, also household DIY and gardening. Max. operating temperature up to 85°C
- Application: One piece self-lock cable tie save the time and make effective for installation.

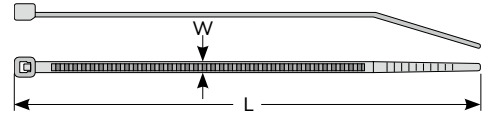

Item No.				Length		W	Max. Bundle Dia.	Min. Loop Tensile Strength	
Natural		Black		mm	inch	mm	mm	lbs	kgs
100pcs	1000pcs	100pcs	1000pcs	200	8"	4.6	48	75	34
CV-200Z	CV-200ZK	CV-200ZB	CV-200ZKB	280	11"	4.8	70		
CV-280Z	CV-280ZK	CV-280ZB	CV-280ZKB	300	11 7/8"	4.8	74		
CV-300SZ		CV-300SZB		368	14 1/2"	4.8	94		
CV-368Z		CV-368ZB							
※CV-300STZ		CV-300STZB		300	11 7/8"	4.8	83	80	36



# 0301 KSS NYLON CABLE TIE



## HVAC Duct Straps

UL 181B-C for use with UL non-metallic air ducts and air connectors. Recommended for use with R-6 and R-8 flex duct.

- Material: UL94V-2 flame rated, UL approved Nylon 66.
- Color: Standard color is natural, black, other special colors are available upon request.
- Feature: Low Smoke and Halogen Free cable tie suitable for various industry, also household DIY and gardening. Max. operating temperature up to 85°C
- Application: One piece self-lock cable tie save the time and make effective for installation.

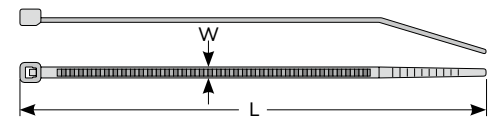

Item No.			Length		W	Max. Bundle Dia.	Min. Loop Tensile Strength	
Natural	Black	Weather Resistant	mm	inch	mm	mm	lbs	kgs
100pcs	100pcs	100pcs						
CV-914	CV-914B	CV-914W	914	36"	9	275	175	80
CV-940	CV-940B	CV-940W	940	37"	9	284		
CV-1219	CV-1219B	CV-1219W	1219	48"	9	372		

## 0301 KSS METAL DETECTABLE CABLE TIE



- Material: UL94HB flame rated Nylon 66 with metal powder.
- Color: Blue, Special color upon request.
- Application: One piece self-lock cable tie for quick installation.
- Feature: Apply for Food and Medical industrial, FDA standard, can be detected by Metal sensor.

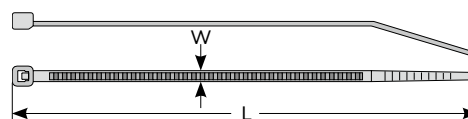

Item No.	Length		W mm	Max. Bundle Dia. mm	Min. LoopTensile Strength		Packing
	mm	inch			lbs	kgs	
CV-100MD	100	4"	2.5	22	14	6	100pcs
CV-150MD	150	6"	3.6	36	25	11	
CV-200MD	203	8"	4.6	52	34	15	
CV-200MMD	203	8"	2.5	55	14	6	
CV-250MD	250	10"	4.8	68	34	15	
CV-280MD	280	11"	4.8	77	34	15	
CV-380MD	380	15"	7.6	105	88	39	
CV-385MD	385	15 3/16"	4.8	110	34	15	
CV-400MD	400	15 3/4"	4.6	116	34	15	

## 0301 KSS EXTRA HIGH TEMPERATURE CABLE TIE



- Material: UL94V-2 flame rated, UL approved Nylon 46.
- Color: Light Brown.
- Application: One piece self-lock cable tie save the time and make effective for installation.
- Feature : Designed for extra high-temperature up to 150°C.

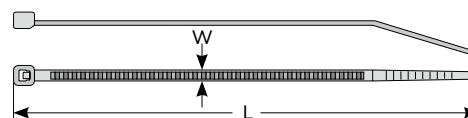

Item No.	Length		W mm	Max. Bundle Dia. mm	Min. LoopTensile Strength		Packing
	mm	inch			lbs	kgs	
CV-100N46	100	4"	2.5	22	18	8	100pcs
CV-150N46	150	6"	3.6	36	40	18	
CV-200N46	203	8"	4.6	52	50	22	
CV-300SN46	300	11 7/8"	4.8	83	50	22	
CV-380N46	380	15"	7.6	105	120	55	
CV-385N46	385	15 3/16"	4.8	110	50	22	

# 0301 KSS HEAT STABILIZED CABLE TIE

- Material: UL94V-2 flame rated, UL approved Nylon 66.
- Color: Light green (standard), black color available.
- Feature: Designed for high-temperature up to 105°C.

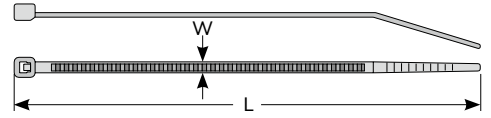

Item No.		Length		W	Max. Bundle Dia.	Min. LoopTensile Strength		Packing
Light green (standard)	Black	mm	inch	mm	mm	lbs	kgs	
CV-100HS	CV-100HSBK	100	4"	2.5	22	18	8	100pcs
CV-140SHS	CV-140SHSBK	142	5 1/2"	2.5	35	18	8	
CV-150HS	CV-150HSBK	150	6"	3.6	36	40	18	
CV-200MHS	CV-200MHSBK	203	8"	2.5	55	18	8	
CV-200HS	CV-200HSBK	203	8"	4.6	52	50	22	
CV-250HS	CV-250HSBK	250	10"	4.8	68	50	22	
CV-300SHS	CV-300SHSBK	300	11 7/8"	4.8	83	50	22	
CV-300HS	CV-300HSBK	300	11 7/8"	7.6	80	120	55	
CV-368HS	CV-368HSBK	368	14 1/2"	4.8	105	50	22	
CV-380HS	CV-380HSBK	380	15"	7.6	105	120	55	

# 0301 KSS NYLON 612 CABLE TIE

- Material: UL94HB flame rated Nylon 612.
- Color: Black
- Application: UV Resistant, Chemical Resistant (zinc chloride, hydrocarbons, salts, bases, acid rain, etc.)
- Feature: Suitable for solar industry (wiring management for galvanized surfaces), and for the environment requiring resistance to outdoors aging and corrosion.

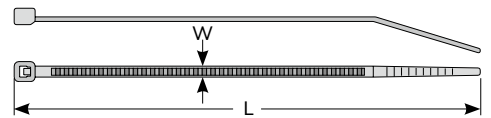

Item No.	Length		W	Max. Bundle Dia.	Min. LoopTensile Strength		Packing
	mm	inch	mm	mm	lbs	kgs	
CV-100N612	100	4"	2.5	22	18	8	100pcs
CV-150N612	150	6"	3.6	36	40	18	
CV-200N612	203	8"	4.6	52	50	22	
CV-250N612	250	10"	4.8	68	50	22	
CV-300SN612	300	11 7/8"	4.8	83	50	22	
CV-368N612	368	14 1/2"	4.8	105	50	22	
CV-370N612	370	14 9/16"	7.6	101	120	55	

## 0301 KSS FLAME RETARDANT CABLE TIE



- Material: **UL94V-0** flame rated, UL approved Nylon 66.
- Color : White (standard), black color available.
- Feature : **94V-0** Flame Retardant.

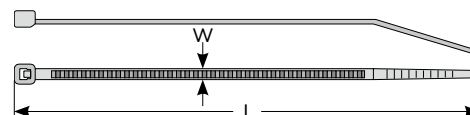

Item No.	Length		W	Max. Bundle Dia.	Min. LoopTensile Strength		Packing
	mm	inch			mm	mm	
CV-100V0	100	4"	2.5	22	18	8	100pcs
CV-150V0	150	6"	3.6	36	40	18	
CV-200MV0	203	8"	2.5	55	18	8	
CV-200V0	203	8"	4.6	52	50	22	
CV-300SV0	300	11 7/8"	4.8	83	50	22	
CV-368V0	368	14 1/2"	4.8	105	50	22	
CV-380V0	380	15"	7.6	105	120	55	

## 0301 KSS POLYPROPYLENE CABLE TIE



- Material: PP.
- Color: Black (natural color upon request)
- Feature: To use at chemical industry, provide better chemical resistant compare with standard cable tie.

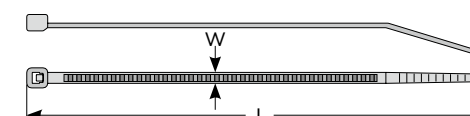

Item No.	Length		W	Max. Bundle Dia.	Min. LoopTensile Strength		Packing
	mm	inch			mm	mm	
CV-150PPBK	150	6"	3.6	36	18	8	100pcs
CV-200PPBK	200	8"	4.6	52	22	10	
CV-240LPPBK	240	9 7/16"	7.6	61	51	23	
CV-250PPBK	250	10"	4.8	68	22	10	
CV-300PPBK	300	11 7/8"	7.6	80	51	23	
CV-380PPBK	380	15"	7.6	105	51	23	
CV-550PPBK	550	21 11/16"	8.0	160	51	23	

# 0301 KSS COLD WEATHER CABLE TIE

- Material: UL94HB flame rated Nylon 66.
- Color: Black.
- Application: One piece self-lock cable tie save the time and make effective for installation.
- Feature: 1. Excellent resistance to low temperature and UV light.  
2. Min. installation temperature: -20°C.  
Min. operating temperature: -40°C.



Item No.	Length		W mm	Max. Bundle Dia. mm	Min. Loop Tensile Strength		Packing
	mm	inch			lbs	kgs	
CV-150CWBK	150	6"	3.6	36	40	18	100pcs
CV-200DCWBK	203	8"	4.8	52	50	22	
CV-250CWBK	250	10"	4.8	68	50	22	
CV-292CWBK	292	11 1/2"	3.6	82	40	18	
CV-300SCWBK	300	11 7/8"	4.8	83	50	22	
CV-368CWBK	368	14 1/2"	4.8	105	50	22	
CV-370CWBK	370	14 9/16"	7.6	101	120	55	
CV-380CWBK	380	15"	7.6	105	120	55	
CV-385CWBK	385	15 3/16"	4.8	110	50	22	
CV-450CWBK	450	17 3/4"	8.0	128	120	55	

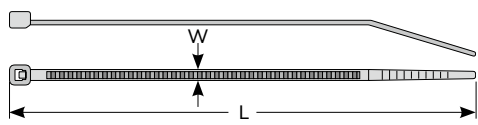

# 0301 KSS EXTRA HEAVY DUTY CABLE TIE



- Material: UL94V-2 flame rated, UL approved Nylon 66.
- Extra heavy duty ties for application where higher tensile strength is needed.

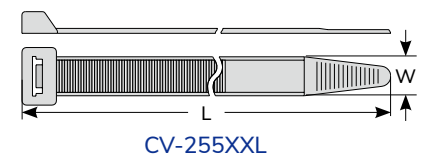
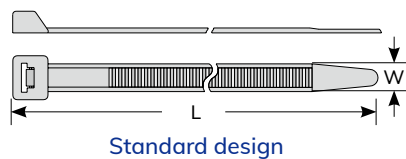

Item No.	Length		W mm	Max. Bundle Dia. mm	Min. Loop Tensile Strength		Packing
	mm	inch			lbs	kgs	
CV-230XL	230	9"	12.7	57	250	114	100 pcs
CV-255XXL	254	10"	17.8	42	120	55	
CV-280XL	280	11"	12.7	73	250	114	
CV-380XL	380	15"	12.7	105	250	114	
CV-480XL	480	18 7/8"	12.7	137	250	114	
CV-550L	550	21 11/16"	12.7	159	250	114	
CV-580XL	580	22 7/8"	12.7	169	250	114	
CV-730XL	730	28 3/4"	12.7	216	250	114	
CV-880XL	880	34 11/16"	12.7	264	250	114	
CV-1030XL	1030	40 1/2"	12.7	312	250	114	
CV-1530XLT	1530	60 1/4"	12.7	473	250	114	

EXTRA HEAVY DUTY





# 0301 KSS UV RESISTANT SUPER STRENGTH NYLON CABLE TIE



- Material: UL94V-2 flame rated, UL approved Nylon 66.
- Color: UV resistant black.
- Carbon black added for excellent resistance to ultra violet in outdoor usage.
- Prolongs useful life of cable tie under sunshine/outdoor application.
- UV resistant cable tie: for outdoor use with UV feature.
- ※ Please make an inquiry if the environment not just UV.

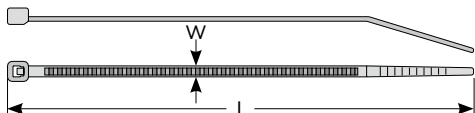

Item No.		Length		W	Max. Bundle Dia.	Min. Loop Tensile Strength	
100pcs	1000pcs	mm	inch	mm	mm	lbs	kgs
CV-200ZW	CV-200ZKW	203	8"	4.6	48	75	34
CV-280ZW	CV-280ZKW	280	11"	4.8	70		
CV-300SZW		300	11 7/8"	4.8	74		
CV-368ZW		368	14 1/2"	4.8	94		
※CV-300STZW		300	11 7/8"	4.8	83	80	36

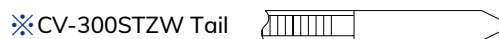

# 0302 KSS TIE GUN

- Economical, pocket type
- Twist to cut surplus tie end after tightening cable. (TG-6)
- Tie gun for stainless steel tie. (TG-20, TG-21)



Item No.	Feature	Suitable Tie Width mm	Weight	Film
TG-3	Automatically cutting when tightens up. Quickly tightens and cuts cable tie tail for one step application. Excellent for industrial assembly. tensile adjustable type.	2.2 ~ 4.8	300 g	
TG-5	Automatically cutting when tightens up. Quickly tightens and cuts cable tie tail for one step application. Excellent for industrial assembly. tensile adjustable type	2.2 ~ 4.8	333 g	
TG-6	Twist tie gun after tighten to cut off cable tie tail manually.	2.5 ~ 5.0	60 g	
TG-7	Automatically cutting when tightens up. Quickly tightens and cuts cable tie tail for one step application. Excellent for industrial assembly. tensile adjustable type.	2.5 ~ 5.0	275 g	
TG-9	Pull the handle to tighten up cable tie. Press to cut off the tail. Designed for cable tie above 5.0mm width.	2.5 ~ 10.0	275 g	
TG-10	Automatically cutting when tightens up. Quickly tightens and cuts cable tie tail for one step application. Excellent for industrial assembly.	4.8 ~ 13.0	320 g	
TG-20	Suitable for stainless steel cable tie. Automatically cutting when tightens up. Quickly tightens and cuts cable tie tail for one step application. Excellent for industrial assembly. tensile adjustable type.	4.5 ~ 7.9	554 g	
TG-21	Suitable for stainless steel cable tie. Pull the handle to tighten up cable tie. Press to cut off the tail.	4.6 ~ 12.0	635 g	



# 0301 KSS UV RESISTANT NYLON CABLE TIE



Wiring Ducts

Cable Markers

Cable Ties

Wrapping Bands

Cable Clamps & Tie Mounts

Glands, Bushings

Conduits

Bushings

Wire Connectors

Tubes

Cable Clips

PCB Parts

Fasteners

- Material: UL94V-2 flame rated, UL approved Nylon 66.
- Color: UV resistant black.
- Carbon black added for excellent resistance to ultra violet in outdoor usage.
- Prolongs useful life of cable tie under sunshine/outdoor application.
- UV resistant cable tie: for outdoor use with UV feature.
- ※Please make an inquiry if the environment not just UV.

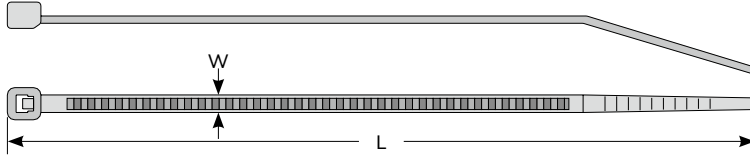

Item No.		Length		W	Max. Bundle Dia.	Min. Loop Tensile Strength		
100pcs	1000pcs	mm	inch	mm	mm	lbs	kgs	
※CVT-070W	CVT-070KW	71	2 13/16"	1.6	16	7	3	MINIATURE
※CVT-100W	CVT-100KW	103	4"	1.95	22	11	5	
CV-060W	CV-060KW	63.7	2 1/2"	2.4	11	18	8	
CV-075W	CV-075KW	75	3"	2.4	15			
CV-080W	CV-080KW	80	3 1/8"	2.5	16			
CV-094W	CV-094KW	96	3 3/4"	2.5	21			
CV-100W	CV-100KW	100	4"	2.5	22			
CV-120SW	CV-120SKW	120	4 3/4"	2.5	28			
CV-140SW	CV-140SKW	142	5 1/2"	2.5	35			
CV-150SW	CV-150SKW	155	6 1/8"	2.5	39			
CV-165W	CV-165KW	165	6 1/2"	2.5	43			
CV-200MW	CV-200MKW	203	8"	2.5	55			
CV-250SW	CV-250SKW	250	10"	2.5	68			
CV-300MW		300	11 7/8"	2.5	80			
CV-400SW		400	15 3/4"	2.5	116			
CV-120W	CV-120KW	120	4 3/4"	3.2	27	40	18	INTERMEDIATE
CV-140W	CV-140KW	142	5 1/2"	3.2	34			
CV-150W	CV-150KW	150	6"	3.6	36			
CV-180W	CV-180KW	180	7"	3.6	46			
※CV-180TW	CV-180TKW	180	7"	3.6	46			
CV-200SW	CV-200SKW	203	8"	3.2	53			
CV-200AW	CV-200AKW	203	8"	3.6	52			
CV-250MW	CV-250MKW	250	10"	3.6	68			
CV-265W	CV-265KW	265	10 1/2"	3.6	73			
CV-292W	CV-292KW	292	11 1/2"	3.6	82			
CV-330W		330	13"	3.6	93			
CV-368SW		368	14 1/2"	3.6	105			
CV-120LW	CV-120LKW	120	4 3/4"	4.8	27	50	22	STANDARD
CV-160LW	CV-160LKW	160	6 1/4"	4.8	39			
CV-190W	CV-190KW	190	7 1/2"	4.8	49			
※CV-190TW	CV-190TKW	190	7 1/2"	4.8	49			
CV-200W	CV-200KW	203	8"	4.6	52			
CV-200DW	CV-200DKW	203	8"	4.8	52			
※CV-200TW	CV-200TKW	203	8"	4.6	52			
CV-250W	CV-250KW	250	10"	4.8	68			

※ CVT-070W doesn't have minimum bundle diameter. ※ CV-200TW Tail  ※ CV-180TW Tail  CV-190TW

# 0301 KSS UV RESISTANT NYLON CABLE TIE



Item No.		Length		W	Max. Bundle Dia.	Min. LoopTensile Strength		
100pcs	1000pcs	mm	inch		mm	lbs	kgs	
CV-280W	CV-280KW	280	11"	4.8	77	50	22	STANDARD
CV-300SW		300	11 7/8"	4.8	83			
CV-310W		310	12"	4.8	86			
CV-350W		350	13 3/4"	4.6	98			
CV-368W		368	14 1/2"	4.8	105			
CV-385W		385	15 3/16"	4.8	110			
CV-400W		400	15 3/4"	4.6	116			
CV-432W		432	17"	4.8	125			
CV-450MW		450	17 3/4"	4.8	131			
CV-500W		500	19 11/16"	4.8	147			
CV-550SW		550	21 11/16"	4.8	162			
CV-610SW		610	24"	4.8	181			
CV-635SW		635	25"	4.8	189			
<b>NEW</b> CV-730SW		730	28 3/4"	4.8	219			
CV-914SW		914	36"	4.8	278			
CV-380SW		380	15"	6.4	108	100	45	HEAVY DUTY
CV-750W		750	29 1/2"	7.5	223	120	55	
CV-120LLW	CV-120LLKW	120	4 3/4"	7.6	22			
CV-150LW	CV-150LKW	150	6"	7.6	32			
CV-200LW	CV-200LKW	203	8"	7.6	52			
CV-240LW	CV-240LKW	240	9 7/16"	7.6	61			
CV-250LW		250	10"	7.6	64			
CV-280LW	CV-280LKW	280	11"	7.6	74			
CV-300W		300	11 7/8"	7.6	80			
CV-340W		340	13 1/2"	7.6	92			
CV-360W		360	14 3/16"	7.6	99			
CV-370W		370	14 9/16"	7.6	101			
CV-380W		380	15"	7.6	105			
CV-610MW		610	24"	7.6	177			
CV-380LW		380	15"	8.0	105			
CV-450W		450	17 3/4"	8.0	128			
CV-500LW		500	19 11/16"	8.0	143			
CV-550W		550	21 11/16"	8.0	160			
CV-450LW		450	17 3/4"	9.0	128			
CV-550DW		550	21 11/16"	9.0	160			
CV-610W		610	24"	9.0	177			
CV-685W		685	27"	9.0	202			
CV-710W		710	28"	9.0	209			
CV-762W		762	30"	9.0	227			
CV-812W		812	32"	9.0	243			
CV-914W		914	36"	9.0	275			
CV-940W		940	37"	9.0	284			
CV-1168W		1168	46"	9.0	356			
CV-1219W		1219	48"	9.0	372			
CV-1500W		1500	59"	9.0	462			
CV-550LW		550	21 11/16"	12.7	159	250	114	

- Wiring Ducts
- Cable Markers
- Cable Ties
- Wrapping Bands
- Cable Clamps & Tie Mounts
- Glands, Bushings
- Conduits
- Bushings
- Wire Connectors
- Tubes
- Cable Clips
- PCB Parts
- Fasteners



# 0305 KSS MOUNTING CABLE TIE

- Material: UL94V-2 flame rated, UL approved Nylon 66.
- Color: Natural (for black. Please add "BK" to Item no.)
- The cable tie can be secured to panel with a single bolt.



Item No.	Length		W	A	Max. Bundle Dia.	Min. LoopTensile Strength		Packing
	mm	inch				lbs	kgs	
TCV-100	110	4 3/8"	2.5	3.2	25	18	8	100pcs
TCV-155	171.5	6 11/16"	3.7	5.0	40	40	18	
TCVS-170	171.5	6 11/16"	3.7	4.0	40	40	18	
TCV-205	219	8 11/16"	4.2	5.0	52	50	22	
TCV-300	300	11 7/8"	4.8	4.8	85	50	22	
TCV-300L	300	12 1/2"	7.8	6.0	80	120	55	
TCV-370	370	14 1/2"	4.8	4.8	102	50	22	
TCV-400	400	15 3/4"	7.9	6.0	112	120	55	

## ● SUPER STRENGTH

Item No.	Length		W	A	Max. Bundle Dia.	Min. LoopTensile Strength		Packing
	mm	inch				lbs	kgs	
<b>NEW</b> TCV-205DZ	219	8 11/16"	4.8	5.0	52	75	34	100pcs

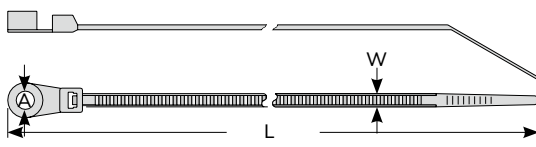

Standard design

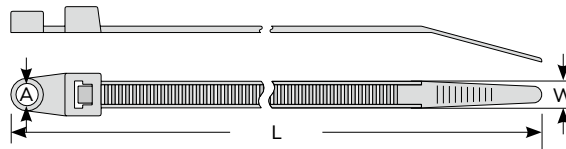

TCV-300L, TCV-400

# 0309 KSS DOUBLE LOOP MOUNTING TIE



- Material: UL94V-2 flame rated, UL approved Nylon 66.
- Color: Black.
- Application: double head design to secure wires, tubing or hoses parallelly separated.
- Feature: two way insertion head design to facilitate fast wire, hoses, tubing bundling from either direction.



Item No.	L		L1		W	Mounting Hole Dia.	Max. Bundle Dia.	Min. LoopTensile Strength		Packing
	mm	inch	mm	inch				lbs	kgs	
DMT-500XLBK	500	19 11/16"	250	10"	12.7	6.2	60	250	114	20pcs

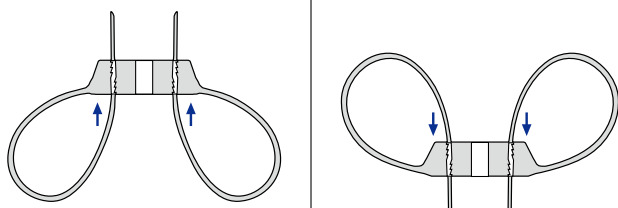

4 way to insertion

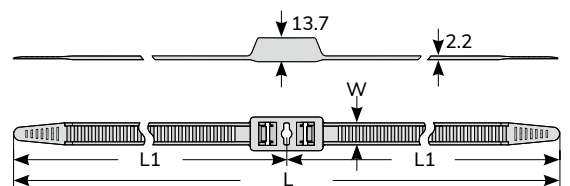
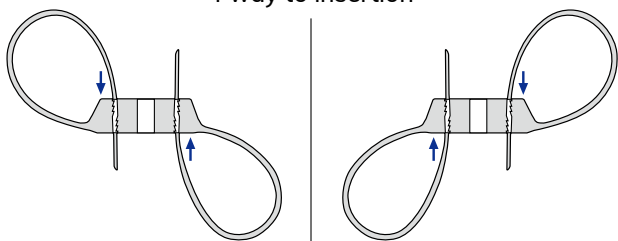

## 0309 KSS DOUBLE HEAD CABLE TIE (UNRELEASABLE)



15-TA1338482-P04 HALOGEN FREE

- Material: UL94V-2 flame rated, UL approved Nylon 66.
- Color: Natural.
- Feature: Double head design, only one tie is needed to bundle two objects.

Item No.	Length		W mm	D1 mm		D2 mm		Min. Loop Tensile Strength		Packing
	mm	inch		MAX.	MIN.	MAX.	MIN.	lbs	kgs	
UNRELEASABLE										
DCV-225	225	8 7/8"	4.8	59	2.5	52	2	50	22	100pcs
DCV-300	300	11 7/8"	4.8	83	2.5	76	2	50	22	
DCV-370	370	14 9/16"	4.8	105	2.5	98	2	50	22	

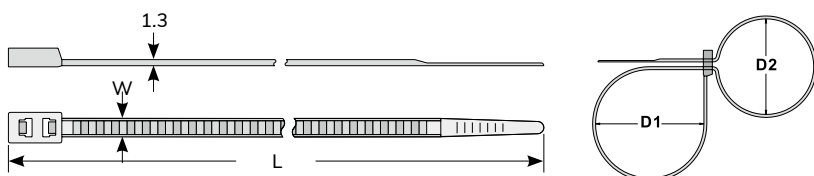

Wiring Ducts

Cable Markers

Cable Ties

Wrapping Bands

Cable Clamps & Tie Mounts

Glands, Bushings

## 0309 KSS DOUBLE HEAD CABLE TIE (RELEASABLE)



15-TA1338482-P04 HALOGEN FREE

- Material: UL94V-2 flame rated, UL approved Nylon 66.
- Color: Natural.
- Feature:
  - Double head design, only one tie is needed to bundle two objects.
  - One of the heads possesses the release design.

Item No.	Length		W mm	D1 mm		D2 mm		Min. Loop Tensile Strength		Packing
	mm	inch		MAX.	MIN.	MAX.	MIN.	lbs	kgs	
RELEASABLE										
RDCV-225	225	8 7/8"	4.8	59	2.5	52	2	50	22	100 pcs
RDCV-300	300	11 7/8"	4.8	83	2.5	76	2	50	22	
RDCV-370	370	14 9/16"	4.8	105	2.5	98	2	50	22	

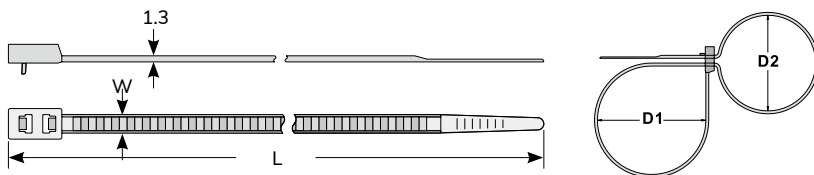

Conduits

Bushings

Wire Connectors

Tubes

Cable Clips

PCB Parts

Fasteners

## 0309 KSS HANDCUFF TIE



- Material: UL94V-2 flame rated, UL approved Nylon 66.
  - Color: Blue.
  - Function: By means of double lock, bind wires or restrict action immediately.
  - Feature: TAIWAN EXCELLENCE 2017 awarded product.
    1. Bundling two things with single tie.
    2. Extra height lock design makes hard to break.
    3. Smoothly inside so it won't hurt hands or wires.
    4. Environmental friendly, wear and impact resistant, easy to carry.
- ※ Special color, length, design, package available on request.



Film

(This Value Pack item No. is VP-10-35NBE)

Item No.	L		L1		W	Max. Bundle Dia.	Min. Loop Tensile Strength		Packing
	mm	inch	mm	inch			lbs	kgs	
DV-900NBE	900	35 1/2"	450	17 3/4"	8.0	127	120	55	10pcs

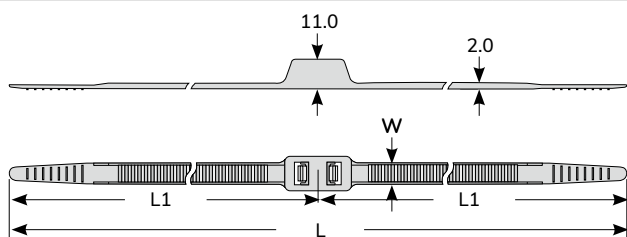

## 0309 KSS TWO WAY CABLE TIE



- Material: UL94V-2 flame rated, UL approved Nylon 66.
- Color: Black, other special colors are available upon request.
- Feature: Special two way lock design allow tie to insert from either side of the head to lock.



Film

TAIWAN EXCELLENCE 2022 awarded product  
(This Value Pack item No. is DP-5-DLC200)

Item No.	Length		W	Max. Bundle Dia.	Min. Loop Tensile Strength		Packing
	mm	inch			lbs	kgs	
DLC-200BK	203	8 "	4.6	50	50	22	100pcs

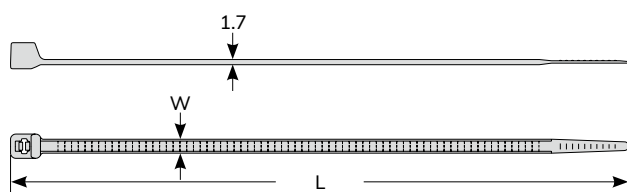

## 0309 KSS TWO WAY RELEASABLE CABLE TIE



HALOGEN FREE

NEW

- Material: UL94V-2 flame rated, UL approved Nylon 66.
- Color: Black.
- Feature:
  1. Special two way lock design allows tie to insert from either side of the head to lock.
  2. Releasable and reusable.

Item No.	Length		W	Max. Bundle Dia.	Min. Loop Tensile Strength		Packing
	mm	inch			lbs	kgs	
RLC-200BK	203	8 "	4.6	50	50	22	100pcs



Film

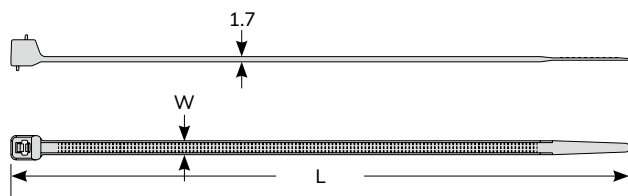

## 0310 KSS BEAD TIE



HALOGEN FREE

- Material: Nylon 66.
- Color: Natural.
- Feature: To secure fire extinguisher pull pin and used as clothing tag tie.

Item No.	Length		W	Max. Bundle Dia.	Min. Loop Tensile Strength		Packing
	mm	inch			lbs	kgs	
TV-130K	145	5 3/4"	1.9	35	11	5	1000pcs

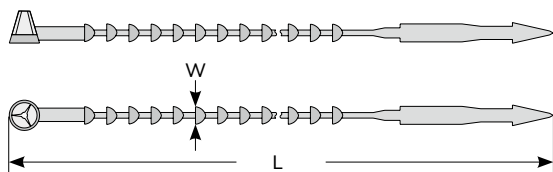



# 0312 KSS RELEASABLE MARKER TIE

- Material: UL94V-2 flame rated, UL approved Nylon 66.
- Color: Natural.
- Tie and identify bundles of cable in one operation. Tag may be imprinted or written on with a Marking Pen.
- Easily assembled by hand or with pliers, remain securely locked until intentionally released by operating the finger catch.

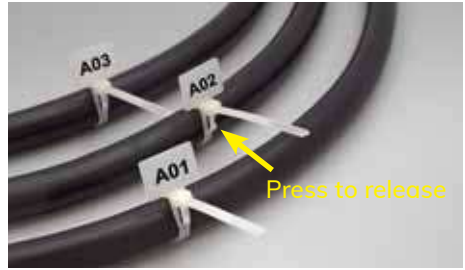

Item No.	Length		W	Max. Bundle Dia.	Min. Loop Tensile Strength		Marking pad A X B	Packing
	mm	inch			lbs	kgs		
MHVC-100	114	4 1/2"	3.6	24	18	8	13 x 19	100pcs
MHVC-200	215	8 1/2"	3.6	50	18	8	13 x 19	

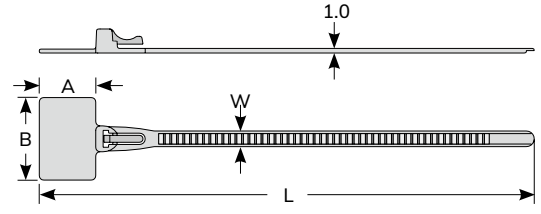

# 0312 KSS MARKER TIE



- Material: UL94V-2 flame rated, UL approved Nylon 66.
- Tie and identify bundles of cable in one operation. Tag may be imprinted or written on with a Marking Pen.

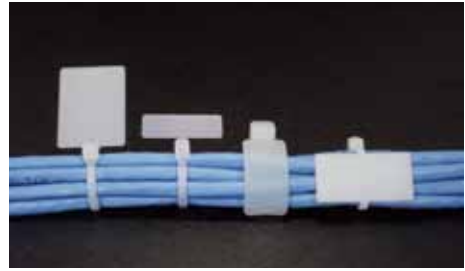

Item No.	Length		W	Max. Bundle Dia.	Min. Loop Tensile Strength		Marking pad A X B	Packing
	mm	inch			lbs	kgs		
MCV-100	100	4"	2.5	23	18	8	8 X 25	100pcs
MCV-100L	130	5 1/8"	2.5	22	18	8	28 X 20	
MCV-110	110	4 3/8"	2.5	20	18	8	8 X 25	
MCV-200	200	8"	4.6	50	50	22	28 X 13	
MCV-200S	200	8"	2.5	50	18	8	15 X 30	
MCV-200SS	200	8"	2.5	50	18	8	8 X 25	
MCV-270	270	11"	4.6	75	50	22	28 X 13	
MCV-300	300	11 7/8"	4.8	82	50	22	54.5 X 13	
MCV-350	350	11 3/4"	4.8	82	50	22	50 X 20	
MCV-370	370	14 9/16"	4.8	105	50	22	54.5 X 13	

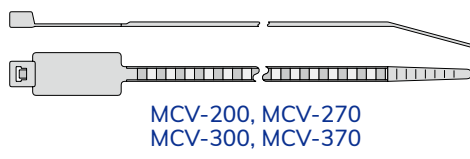
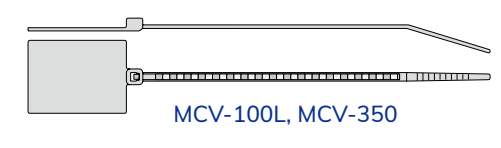
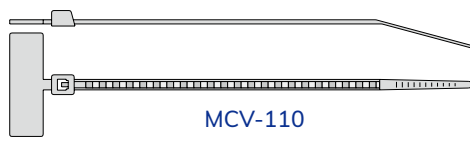
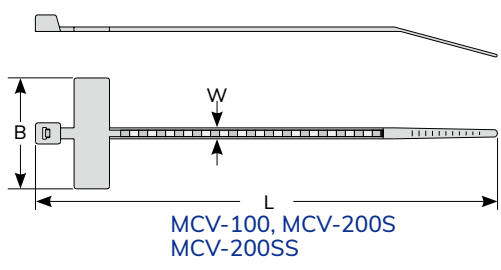



# 0313 KSS SECURITY MARKER TIE

- Material: UL94V-2 flame rated, UL approved Nylon 66.
- Color: Yellow.
- Application: Use to fix fire extinguisher plug, also can be as security lock tie for logistics, transportation, courier service and other similar industrial.



Item No.	Length		W	Max. Bundle Dia.	Marking pad A X B	Packing
	mm	inch				
SCT-190YW	191.5	7 1/2"	2.9	40	23.7 x 17.5	100pcs

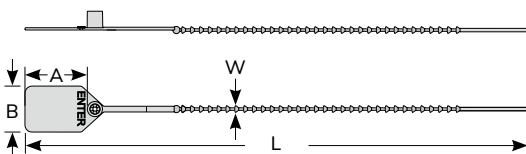

Film

Wiring Ducts

Cable Markers

Cable Ties

Wrapping Bands

Cable Clamps & Tie Mounts

# 0313 KSS SECURITY MARKER TIE

- Material: UL94V-2 flame rated, UL approved Nylon 66.
  - Feature: for the purpose of identification for security service logistics, transportation and courier.
- The size of marker plate could be made or carved LOGO upon customer's request.



Item No.	Length		W	Max. Bundle Dia.	Marking pad A X B	Packing
	mm	inch				
SCT-110	111	4 3/8"	2.6	20	8 X 27.6	100pcs
SCT-250	248.5	10"	3.5	50	36 X 19	
NEW SCT-295	295.4	11 5/8"	3.0	68	40 X 20	
SCT-400	400	15 3/4"	4.8	102	36.5 X 19	

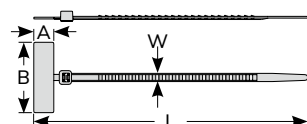

SCT-110

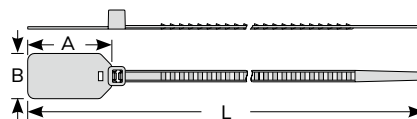

SCT-295

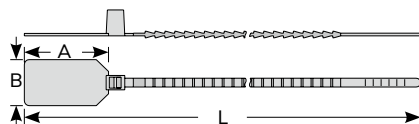

SCT-250

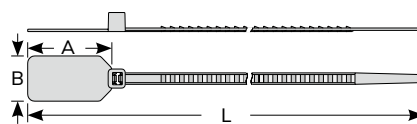

SCT-400

Glands, Bushings

Conduits

Bushings

Wire Connectors

Tubes

Cable Clips

PCB Parts

Fasteners

# 0314 KSS MARKER TIE

- Material : PE.
- Color: Natural.
- Put the marking paper chip into marker box.



Item No.	Length		W	Max. Bundle Dia.	Marking pad A X B	Packing
	mm	inch	mm	mm	mm	
PMT-150	160	6 1/4"	5.0	25	9.2 X 30	100pcs

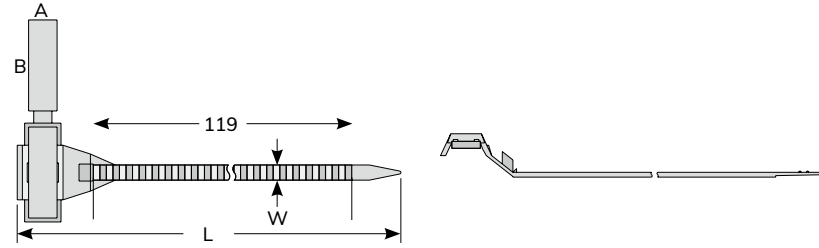

Wiring Ducts

Cable Markers

Cable Ties

Wrapping Bands

# 0315 KSS EASY RELEASABLE CABLE TIE

- Material: UL94V-2 flame rated, UL approved Nylon 66.
- Color: Black.
- Feature: TAIWAN EXCELLENCE 2019 awarded product.
  - 1.Head design provides simple and easy to open the strap with a finger.
  - 2.Outside serrated design helps to protect the wires/cables.
  - 3.Releasable and reusable.



Item No.	Length		W	Max. Bundle Dia.	Min. Loop Tensile Strength		Packing
	mm	inch	mm	mm	lbs	kgs	
HB-200BK	218	8 9/16"	7.5	57	44	20	100pcs
NEW HB-250BK	261.9	10 5/16"	7.5	72	44	20	
NEW HB-300BK	311.9	12 5/16"	7.5	88	44	20	
NEW HB-370BK	381.9	15"	7.5	111	44	20	

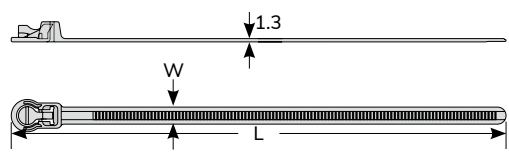

Film

TAIWAN EXCELLENCE 2019 awarded product (This Value Pack item No. is PHB-200BK-10)

Conduits

Bushings

Wire Connectors

# 0315 KSS EASY RELEASABLE CABLE TIE

- Material: UL94V-2 flame rated, UL approved Nylon 66.
- Color: Black.
- Feature:
  1. Easy releasing trigger with round shape design allows opening with only one hand. The excess tail can be neatly tucked away.
  2. Smooth surface to the bundle avoids damage to the object.
  3. Releasable and reusable.



Item No.	Length		W	Max. Bundle Dia.	Min. Loop Tensile Strength		Packing
	mm	inch	mm	mm	lbs	kgs	
HBC-190BK	203.8	8"	7.4	53	44	20	100pcs

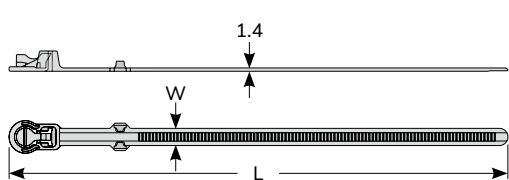

Film

Tubes

Cable Clips

PCB Parts

Fasteners

# 0315 KSS SNAP-LOCK RELEASABLE CABLE TIE



- Material: UL94V-2 flame rated, UL approved Nylon 66.
- Color: Black.
- Feature:
  1. Special head design with high tensile strength.
  2. Sharp tail design for easy insertion.
  3. Releasable and reusable.
  4. Special head top design connects two cable ties together.

Item No.	Length		W	Max. Bundle Dia.	Min. Loop Tensile Strength		Packing
	mm	inch			lbs	kgs	
LHV-200BK	204.5	8"	4.5	50	50	22	100pcs

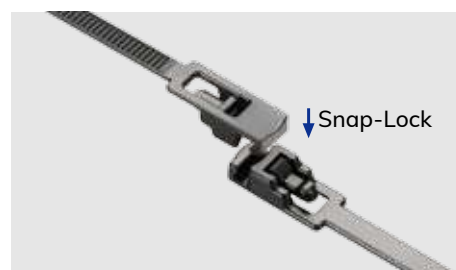
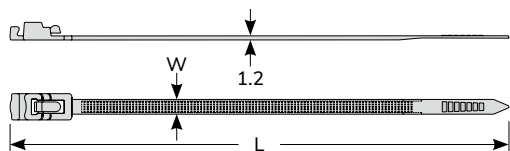

Wiring Ducts

Cable Markers

Cable Ties

Wrapping Bands

# 0315 KSS SNAP-LOCK RELEASABLE CABLE TIE ACCESSORIES



- Material: UL94V-2 flame rated, UL approved Nylon 66.
- Color: Black.
- Application: Assemble the accessories with the slot on top of LHV-200BK. LHT-1BK is suitable for hole diameter 5mm, can be fixed by screw. LHP-1BK is suitable for chassis board with hole width 6mm, and thickness 3mm. With LHC-1BK, the excess tail of LHV-200BK can be tucked neatly away.
- Feature: User can adjust to extend item LHV-200BK, depending on different needs.

Item No.	Type	Suitable Cable Tie	Packing
LHT-1BK	Mounting hole	LHV-200BK	100pcs
LHP-1BK	Push mount		
LHC-1BK	Tuckaway		

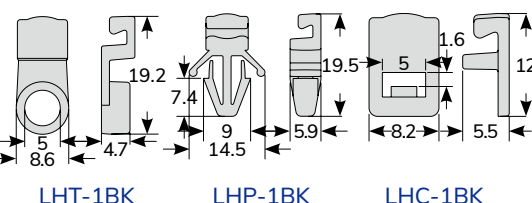
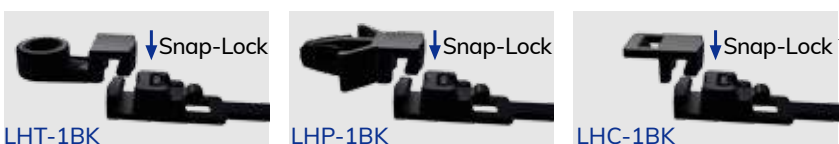

# 0315 KSS RELEASABLE CABLE TIE



- Material: UL94V-2 flame rated, UL approved Nylon 66.
- Color: Black, Natural.
- Feature: TAIWAN EXCELLENCE 2019 awarded product.
  1. Special lock design makes good tensile strength.
  2. Sharp tail for easy installation.
  3. Releasable and reusable.

Item No.		Length		W	Max. Bundle Dia.	Min. Loop Tensile Strength		Packing
Black	Natural	mm	inch			lbs	kgs	
HV-125SBK	HV-125S	125	4 15/16"	4.5	25	50	22	100pcs
HV-150SBK	HV-150S	150	6"	4.5	35	50	22	
HV-200SBK	HV-200S	200	8"	4.5	50	50	22	
HV-250SBK	HV-250S	250	10"	4.5	65	50	22	
HV-300SBK	HV-300S	300	11 7/8"	4.5	80	50	22	

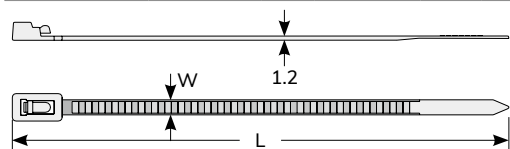

TAIWAN EXCELLENCE 2019 awarded product (This Value Pack item No. is PC-12-HV150S)

Tubes

Cable Clips

PCB Parts

Fasteners

## 0315 KSS RELEASABLE CABLE TIE

- Material: UL94V-2 flame rated, UL approved Nylon 66.
- Color: Black, Natural.
- Easily assembled by hand or with pliers, remain securely locked until intentionally released by operating the finger catch.

Item No.		Length		W	Max. Bundle Dia.	Min. Loop Tensile Strength		Packing
Black	Natural	mm	inch	mm	mm	lbs	kgs	
HV-125BK	HV-125	125	4 15/16"	7.6	30	50	22	100pcs
HV-150BK	HV-150	150	6"	7.6	35	50	22	
HV-200BK	HV-200	203	8"	7.6	50	50	22	
HV-250BK	HV-250	250	10"	7.6	65	50	22	
HV-300BK	HV-300	300	11 7/8"	7.6	80	50	22	
HV-500BK	HV-500	500	19 11/16"	8.5	145	75	34	

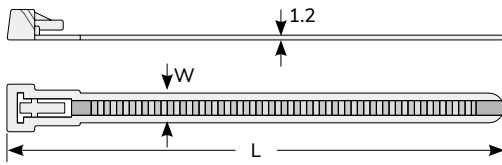

## 0315 KSS RELEASABLE CABLE TIE

- Material: UL94V-2 flame rated, UL approved Nylon 66.
- Color: Black, Natural.
- Easily assembled by hand or with pliers, remain securely locked until intentionally released by operating the finger catch.

Item No.		Length		W	Max. Bundle Dia.	Min. Loop Tensile Strength		Packing
Black	Natural	mm	inch	mm	mm	lbs	kgs	
HVC-125BK	HVC-125	125	4 15/16"	7.6	30	50	22	100pcs
HVC-150BK	HVC-150	150	6"	7.6	41	50	22	
HVC-200BK	HVC-200	203	8"	7.6	58	50	22	
HVC-250BK	HVC-250	250	10"	7.6	73	50	22	
HVC-300BK	HVC-300	300	11 7/8"	7.6	89	50	22	
HVC-370BK	HVC-370	370	14 5/8"	7.6	108	50	22	

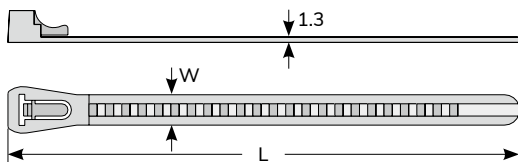

# 0316 KSS RELEASABLE CABLE TIE

- Material: UL94V-2 flame rated, UL approved Nylon 66.
- Finger catch design to release cable tie locking. Ideal for temporary fastening purpose.

✳ RCV-780T Tail



Item No.	Length		W	Max. Bundle Dia.	Min. Loop Tensile Strength		Packing
	mm	inch			lbs	kgs	
RCV-100	102	4"	3.6	25	40	18	100pcs
RCV-150	150	6"	4.6	39	50	22	
RCV-200	200	8"	4.6	55	50	22	
RCV-250	250	10"	4.8	74	50	22	
RCV-300	300	11 7/8"	4.8	88	50	22	
RCV-370	370	14 9/16"	4.8	102	50	22	
NEW ✳ RCV-780T	780	30 3/4"	9.0	230	175	80	
RCV-914	914	36"	9.0	275	175	80	
RCV-1219	1219	48"	9.0	372	175	80	
RCV-230XL	232.5	8 15/16"	12.8	60	250	114	
RCV-290XL	292.5	11 1/2"	12.8	79	250	114	
RCV-405XL	407.5	16"	12.8	116	250	114	
RCV-480XL	482.5	18 7/8"	12.8	140	250	114	
RCV-580XL	576.6	22 7/8"	12.8	172	250	114	

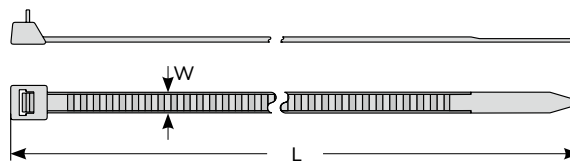
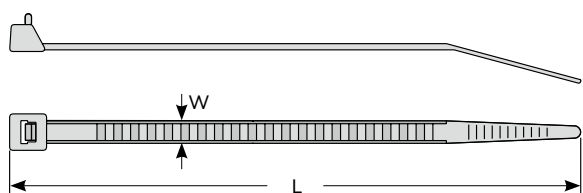

# 0316 KSS RELEASABLE LASHING CABLE TIE

- Material: UL94V-2 flame rated, UL approved Nylon 66.
- Finger catch design to release cable tie locking. Ideal for temporary fastening purpose.

Item No.	Length		W	Max. Bundle Dia.	Min. Loop Tensile Strength		Packing
	mm	inch			lbs	kgs	
HRCV-240XL	240	9 7/16"	12.8	60	250	114	100pcs
HRCV-300XL	300	11 7/8"	12.8	79	250	114	
HRCV-415XL	415	16 5/16"	12.8	116	250	114	
HRCV-490XL	490	19 5/16"	12.8	140	250	114	
HRCV-590XL	590	23 1/4"	12.8	170	250	114	

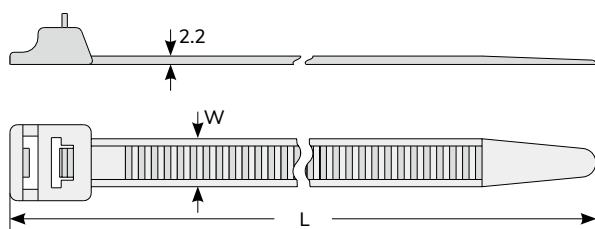

## 0318 KSS PUSH MOUNT COLLECT TIE

- Material: UL94V-2 flame rated, UL approved Nylon 66.
- Application: Drill a 5.4mm diameter round hole near electrical outlet and fix cables to the panel board.
- Function: Suitable for cable binding and fixing on industrial and home electronics.
- Feature: Releasable.

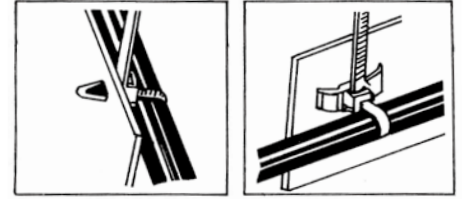

Item No.	Length		W mm	Max. Bundle Dia. mm	Min. Loop Tensile Strength		Packing
	mm	inch			lbs	kgs	
PHV-150	152.5	6"	7.9	37	30	13	100pcs

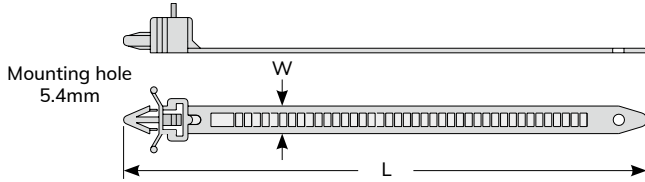

## 0319 KSS SADDLE MOUNTING TIE

- Material: UL94V-2 flame rated, UL approved Nylon 66.
- Application: Fix with the bolt (as Figure) and insert the tie through the locking head.



Item No.	Length		W mm	Packing
	mm	inch		
PMA-150	144.6	5 11/16"	7	100pcs

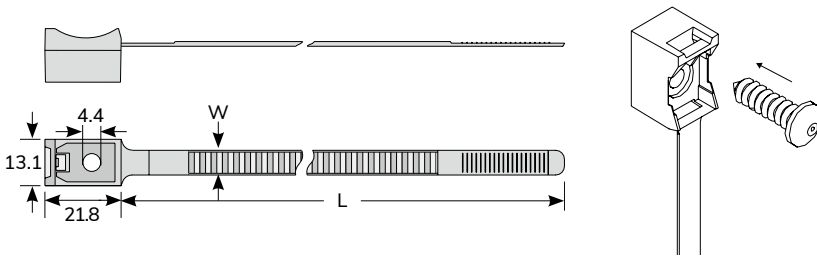

## 0319 KSS SADDLE MOUNTING TIE

- Material: UL94V-2 flame rated, UL approved Nylon 66.
- Color: Natural.
- Application: Drill an 8mm diameter round hole for CWP-38 wall plug (as Figure), insert CWP-38 onto the tie head and fix objects on the wall by locking the tie. The tie can also be fixed on the wall with the bolt.
- Standard color is natural, other special colors are available upon request.



Item No.	Length		W mm	Packing
	mm	inch		
PMB-145	144.6	5 11/16"	7.1	100pcs
PMB-240	238.2	9 3/8"	7.1	

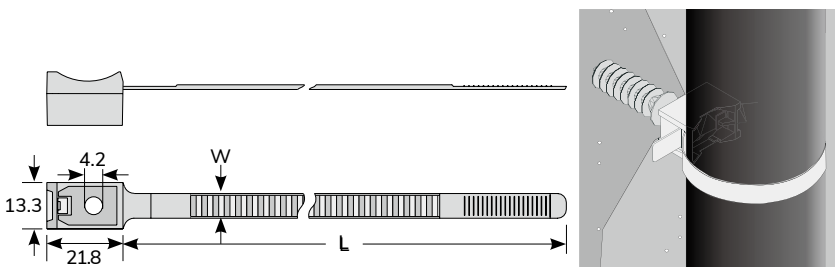

(Refer to P.106)

CWP-38

# 0320 KSS DOUBLE LOCKING CABLE TIE

- Material : UL94V-2 flame rated, UL approved Nylon 66 or UL94HB flame rated, UL approved Nylon 12.
- Color: Natural, Black.
- Single locking head: DL-132, DL-180

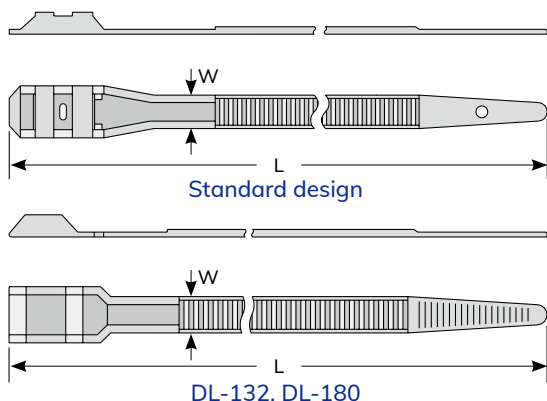

## ◆ NYLON 66 Single locking

Item No.		Length		W	Max. Bundle Dia.	Min. LoopTensile Strength		Packing
Natural	Black	mm	inch	mm	mm	lbs	kgs	
DL-132	DL-132BK	132	5 1/8"	9	25	79	36	100pcs
DL-180	DL-180BK	180	7"	9	40	79	36	

## ◆ NYLON 66 Double locking

Item No.		Length		W	Max. Bundle Dia.	Min. LoopTensile Strength		Packing
Natural	Black	mm	inch	mm	mm	lbs	kgs	
DL-235	DL-235BK	235	9 1/4"	9	53	120	55	100pcs
DL-265	DL-265BK	265	10 1/2"	9	78	120	55	
DL-300	DL-300BK	300	11 7/8"	9	88	120	55	
DL-360	DL-360BK	360	14 1/4"	9	100	120	55	
DL-510	DL-510BK	510	20"	9	150	120	55	
DL-610	DL-610BK	610	24"	9	180	120	55	
DL-760	DL-760BK	760	30"	9	230	120	55	

## ◆ NYLON 12 Single locking

Item No.	Length		W	Max. Bundle Dia.	Min. LoopTensile Strength		Packing
Black	mm	inch	mm	mm	lbs	kgs	
DL-132N12BK	132	5 1/8"	9	25	55	25	100pcs
DL-180N12BK	180	7"	9	40	55	25	

## ◆ NYLON 12 Double locking

Item No.	Length		W	Max. Bundle Dia.	Min. LoopTensile Strength		Packing
Black	mm	inch	mm	mm	lbs	kgs	
DL-235N12BK	235	9 1/4"	9	53	112	51	100pcs
DL-265N12BK	265	10 1/2"	9	78	112	51	
DL-300N12BK	300	11 7/8"	9	88	112	51	
DL-360N12BK	360	14 1/4"	9	100	112	51	
DL-510N12BK	510	20"	9	150	112	51	
DL-610N12BK	610	24"	9	180	112	51	
DL-760N12BK	760	30"	9	230	112	51	

# 0320 KSS DOUBLE LOCKING CABLE TIE

- Material : UL94HB flame rated Nylon 6.
- Color: Black.



Wiring Ducts

Cable Markers

Cable Ties

Wrapping Bands

Cable Clamps & Tie Mounts

Glands, Bushings

Conduits

Bushings

Wire Connectors

Tubes

Cable Clips

PCB Parts

Fasteners

## ◆ NYLON 6 Single locking

Item No.	Length		W mm	Max. Bundle Dia. mm	Min. Loop Tensile Strength		Packing
	mm	inch			lbs	kgs	
DL-180N6BK	180	7"	9	40	80	36	100pcs

## ◆ NYLON 6 Double locking

Item No.	Length		W mm	Max. Bundle Dia. mm	Min. Loop Tensile Strength		Packing
	mm	inch			lbs	kgs	
DL-265N6BK	265	10 1/2"	9	63	120	55	100pcs
DL-360N6BK	360	14 1/4"	9	92	120	55	
DL-510N6BK	510	20"	9	141	120	55	
DL-760N6BK	760	30"	9	220	120	55	

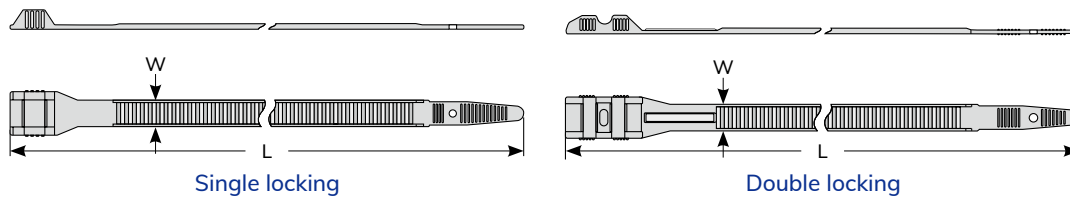

# 0320 KSS DOUBLE LOCKING CABLE TIE

- Material: UL94V-2 flame rated, UL approved Nylon 66.



## ◆ Single locking

Item No.	Length		W mm	Max. Bundle Dia. mm	Min. Loop Tensile Strength		Packing	
	Black	Natural			mm	inch		lbs
DK-132SBK			132	5 1/8"	6	25	50	100pcs
DK-180SBK			180	7"	6	40	50	
DK-180BK			180	7"	9	40	80	
DK-200BK	DK-200		201	8"	9	47	80	

## ◆ Double locking

Item No.	Length		W mm	Max. Bundle Dia. mm	Min. Loop Tensile Strength		Packing	
	Black	Natural			mm	inch		lbs
DK-265BK			265	10 1/2"	9	64	120	100pcs
DK-290BK	DK-290		292	11 1/2"	9	72	120	
DK-360BK			360	14 1/4"	9	95	120	
DK-380BK	DK-380		382	15"	9	100	120	
DK-510BK			510	20"	9	142	120	
DK-610BK	DK-610		610	24"	9	174	120	
DK-760BK			760	30"	9	214	120	

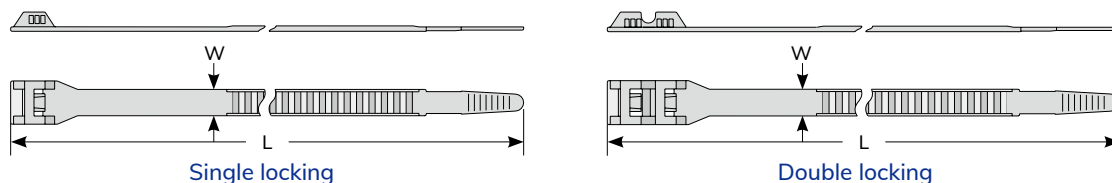



## 0321 KSS IN-LINE CABLE TIE

- Material: UL94V-2 flame rated, UL approved Nylon 66.
- Color : Natural and Black, other colors are available upon request.
- Feature: Flat headed low profile design to be used with playground equipment to avoid harming playing children.



Item No.	Length		W mm	Max. Bundle Dia. mm	Packing
	mm	inch			
FCV-255	255	10"	9	74	100pcs
FCV-391	391	15 1/2"	9	117	

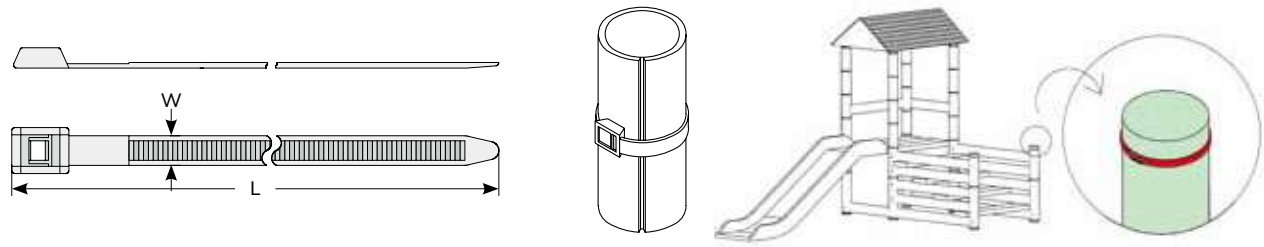

## 0321 KSS OUTSIDE SERRATED CABLE TIE

- Material: UL94V-2 flame rated, UL approved Nylon 66.
- Feature : Reverse-insert design with pawl outside to eliminate the damage of object.



Item No.	Length		W mm	Max. Bundle Dia. mm	Packing
	mm	inch			
RRCV-100	103	4"	2.5	23	100pcs
RRCV-200D	203	8"	4.8	52	

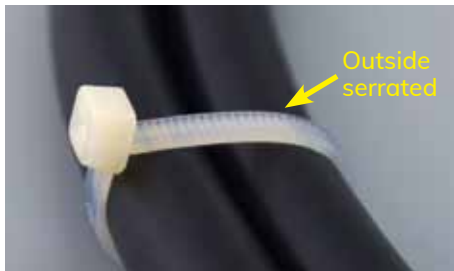
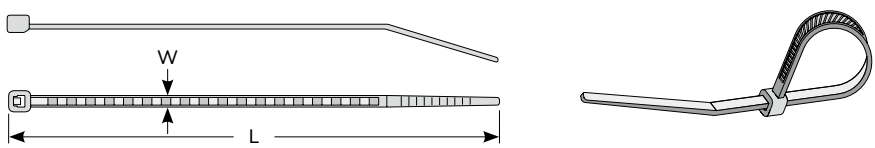

## 0325 KSS KNOT TIE (BEAD TYPE)

- Material: UL94V-2 flame rated, UL approved Nylon 66.
- Color: Natural.
- Easy to install and release.
- Beaded design keeps wires from shifting or slipping.



Item No.	Length		W mm	Max. Bundle Dia. mm	Packing
	mm	inch			
TV-100	103	4"	2.5	25	100pcs
TV-120	120	4 3/4"	2.4	30	
TV-150	150	6"	2.9	39	
TV-180	180	7"	2.9	49	
TV-230	226	8 15/16"	3.8	63	
TV-280	273	11"	3.0	75	

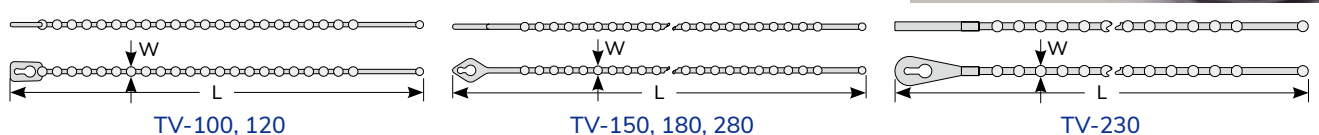

# 0326 KSS DOUBLE HEAD KNOT TIE

- Material :UL94V-2 flame rated, UL approved Nylon 66.
- Easy to install and release.
- Beaded design keeps wires from shifting or slipping.



## ◆ NYLON 66

Item No.		Length		W	Max. Bundle Dia.	Packing
Natural	Black	mm	inch	mm	mm	
KTV-145	KTV-145BK	145	5 3/4"	2.0	35	100pcs
KTV-150	KTV-150BK	150	6"	3.6	38	
KTV-170	KTV-170BK	167	6 9/16"	3.9	41	
KTV-180	KTV-180BK	180	7"	3.6	46	
KTV-230	KTV-230BK	230	8 15/16"	3.6	62	

- Material : PE
- Easy to install and release.
- Beaded design keeps wires from shifting or slipping.

## ◆ PE

Item No.		Length		W	Max. Bundle Dia.	Packing
Natural	Black	mm	inch	mm	mm	
KTV-145E	KTV-145EBK	145	5 3/4"	2.0	35	100pcs
KTV-150E	KTV-150EBK	150	6"	3.6	38	
KTV-170E	KTV-170EBK	167	6 9/16"	3.9	41	
KTV-180E	KTV-180EBK	180	7"	3.6	46	
KTV-230E	KTV-230EBK	230	8 15/16"	3.6	62	

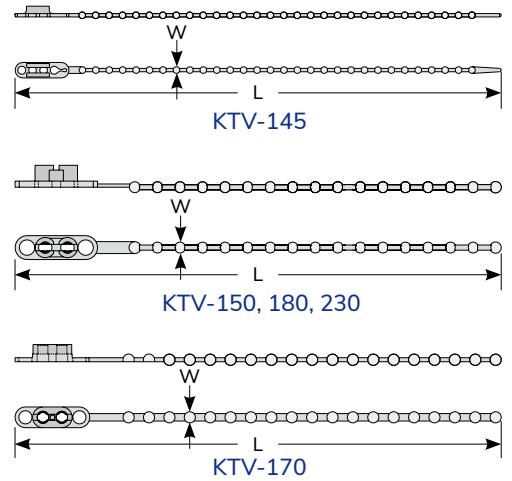

# 0327 KSS KNOT TIE

- Material: UL94V-2 flame rated, UL approved Nylon 66.
- Mounting hole Diameter 6 mm ; chassis thickness 1.6 mm.
- Easy to install and release.
- Beaded design keeps wires from shifting or slipping.

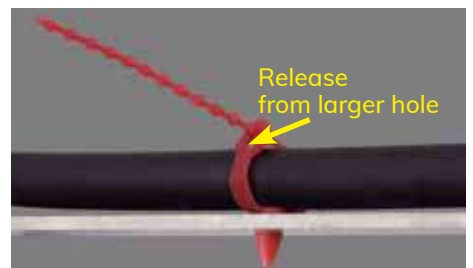

Item No.		Length		W	Max. Bundle Dia.	Packing
Red	Natural	mm	inch	mm	mm	
STV-130RD7	STV-130	130	5 1/8"	3	35	100pcs

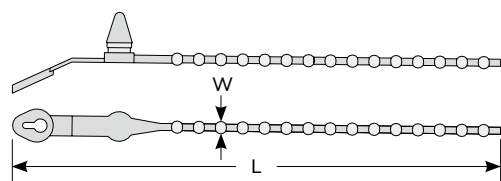

## 0330 KSS WIRE COLLECT TIE

- Material: PE.
- Color: Natural, Black.
- Application: Wrap electrical cords for shipping and packaging.
- Put the wire into A (see the diagram) firstly then roll up the wire and end it by collect tie.

Item No.		Length		W	Max. Bundle Dia.	Packing
Natural	Black	mm	inch	mm	mm	
TL-1	TL-1BK	130	5 1/8"	15.5	35	100pcs
PCT-140	PCT-140BK	142	5 1/2"	9.0	38	
WL-160	WL-160BK	160	6 1/4"	8.5	45	
WLT-230	WLT-230BK	234	9 1/16"	5.5	50	
	WLT-350BK	350	13 3/4"	7.0	100	

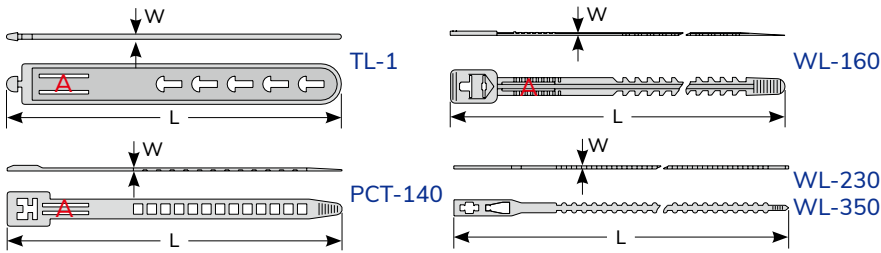

Wiring Ducts

Cable Markers

Cable Ties

Wrapping Bands

Cable Clamps & Tie Mounts

## 0332 KSS WIRE COLLECT TIE

- Material: UL94V-2 flame rated, UL approved Nylon 66.

Item No.		Length		W	Max. Bundle Dia.	Min. Loop Tensile Strength		Packing
Natural	Black	mm	inch	mm	mm	lbs	kgs	
WCT-165	WCT-165BK	165	6 1/2"	7	44	50	22	100pcs

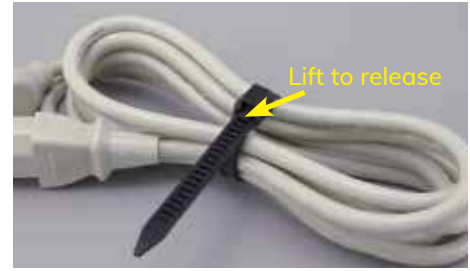
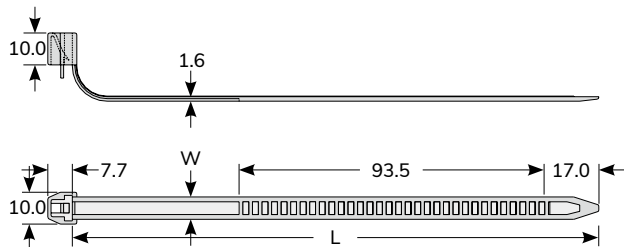

Glands, Bushings

Conduits

Bushings

Wire Connectors

## 0335 KSS RELEASABLE PUSH MOUNT TIE

- Material: UL94V-2 flame rated, UL approved Nylon 66.
- Application: Drill the panel board, insert the tie into the hole and fasten the cable.
- Feature: Releasable.

Item No.	Length		W	Max. Bundle Dia.	Mounting hole diameter	Chassis thickness	Min. Loop Tensile Strength		Packing
	mm	inch	mm	mm	mm	mm	lbs	kgs	
PDV-170BK	169	6 5/8"	5.0	36	7.0	15	40	18	100pcs

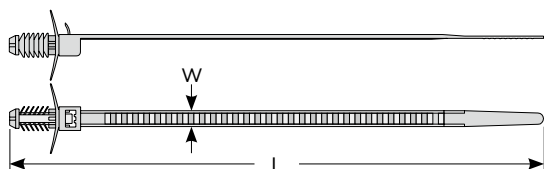

Tubes

Cable Clips

PCB Parts

Fasteners



# 0335 KSS PUSH MOUNT TIE

- Material: UL94V-2 flame rated, UL approved Nylon 66.
- Press the tie into a pre-drilled hole and bind the cord by securing the tie.
- PRVS-130HSBK : UL approved heat stabilized Nylon 66, 94V-2 black.



Using Method

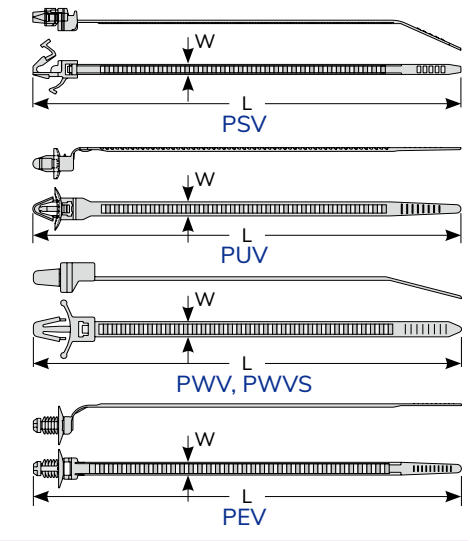
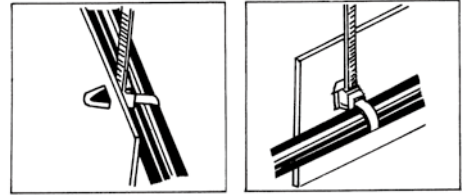

Item No.	Length		W	Max. Bundle Dia.	Mounting hole diameter	Chassis thickness	Min. LoopTensile Strength		Packing
	mm	inch					lbs	kgs	
PCVS-130	132	5 1/8"	4.8	30	4.8	3.0	50	22	100pcs
PCV-155	168	6 1/8"	3.8	40	4.8	3.0	40	18	
PCVS-200	203	8"	4.8	50	4.8	3.0	50	22	
PCV-200	203	8"	4.8	50	6.4	3.0	50	22	
PEV-170BK	170	6 11/16"	5.3	40	6.8	12.0	26	12	
PFVS-130	131	5 1/8"	3.7	30	4.8	2.4	40	18	
PFVS-155	157.5	6 1/8"	3.7	38	4.8	2.4	40	18	
PFVS-200	207	8"	3.7	50	4.8	2.4	40	18	
PGV-100	101	4 1/8"	3.4	25	4.8	2.5	40	18	
PGV-130	135	5 5/16"	3.4	33	4.8	2.5	40	18	
PSV-130	132	5 1/8"	4.8	30	6.4	3.3	50	22	
PSV-200	202	8"	4.8	50	6.4	3.3	50	22	
PUV-170	168.6	6 5/8"	5.4	38	6.8	1.6	50	22	
PWVS-100	112	4 3/8"	2.5	25	4.6	2.6	18	8	
PWVS-130	133	5 1/8"	4.8	30	4.6	4.5	50	22	
PWVS-155	157	6 1/8"	3.5	36	4.6	2.6	40	18	
PWV-130	132	5 1/8"	4.8	30	6.2	2.8	50	22	
PWV-170	170	6 11/16"	4.6	40	6.0	3.0	50	22	
PWV-200	201	8"	4.8	50	6.2	2.8	50	22	
PRVS-130HSBK	134.5	5 1/4"	4.8	30	8.2	5.0	50	22	

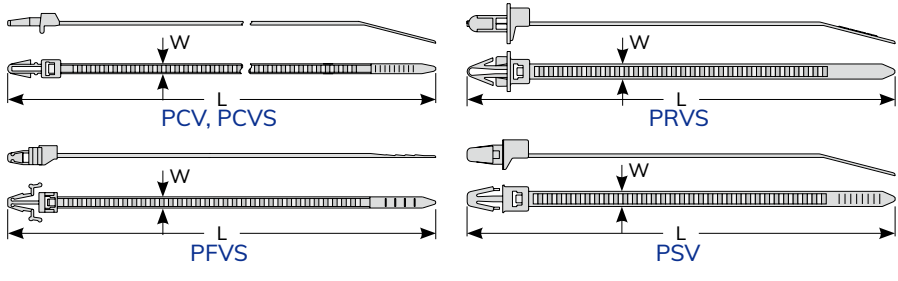

# 0340 KSS CABLE TRAY FIXING TIE

- Material: UL94V-2 flame rated, UL approved Nylon 66.
- Application: 1.Snap the cable tray fixing tie from (A) to separate the head and the tail.  
2.Slot each (B) into either side of the tray and fix both parts by twisting 90 degree.  
3.Secure the cables and wires on dedicated area.
- Suitable slot: 8mm

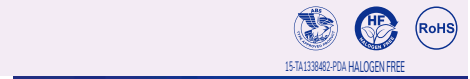

Item No.		Length		L1	L2	W	Min. LoopTensile Strength		Packing
Black	Natural	mm	inch	mm	mm	mm	lbs	kgs	
CTF-320BK	CTF-320	320	12 5/8"	40	278	7.6	120	55	100pcs

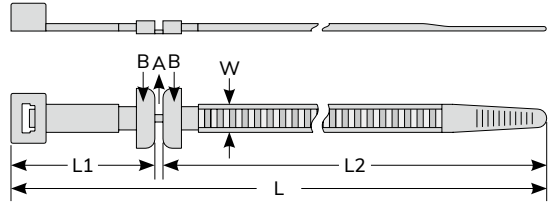

# 0342 KSS CHASSIS TIE

● Material: UL94V-2 flame rated, UL approved Nylon 66.

Item No.	Length		W	Max. Bundle Dia.	Packing
	mm	inch			
KFC-300BK	304	11 7/8"	6.2	85	100pcs
KFC-380BK	380	15"	7.6	100	
KFS-380BK	380	15"	7.6	100	

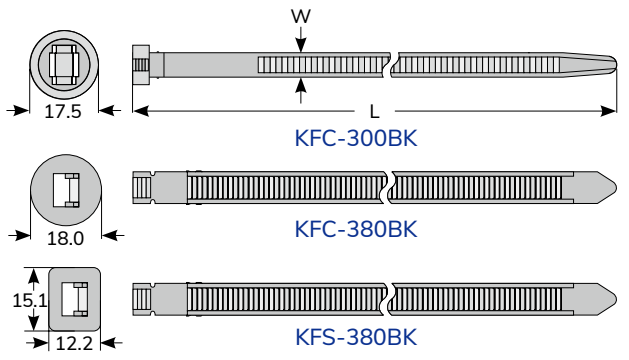

# 0343 KSS MOUNTING ADJUSTABLE TIE

- Material: UL94V-2 flame rated, UL approved Nylon 66.
- Application: Press the tie head against the bolt, which is fixed to the board panel, and fasten the cable by locking the tie.
- Feature: 1. Ladder Design Strap, which is adjustable.  
2. Loose by rotating it counterclockwise.

Item No.	Length		W	Screw	Packing
	mm	inch			
MAT-120BK	120	4 3/4"	10	5.0	100pcs

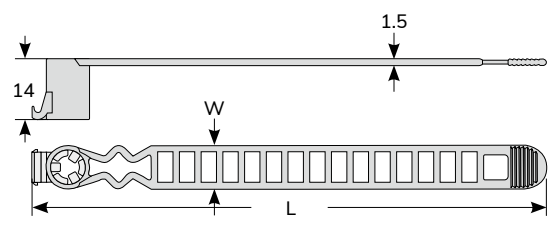

# 0355 KSS NYLON CABLE TIE WITH STOPPER

- Material: UL94V-2 flame rated, UL approved Nylon 66.
- Feature: A stopper built on tie to ensure the minimum bundle loop.

Item No.	Length		W	Max. Bundle Dia.	Min. Loop Tensile Strength		Packing
	mm	inch			lbs	kgs	
CVS-140	142	5 1/2"	3.2	20	40	18	100pcs
CVS-190	190	7 1/2"	4.8	45	50	22	
CVS-380XL	380	15"	12.7	105	250	114	

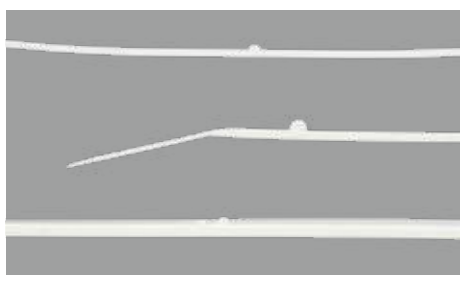
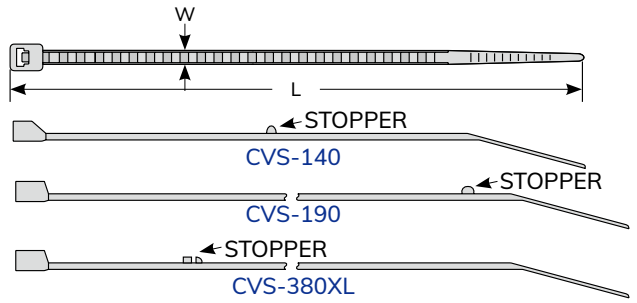

# 0350 KSS MAGIC TIE

- Material: Hook Side: PP, Loop Side: Nylon.
- Color: Black (BK), White (WE), Red (RD), Yellow (YW), Blue (BE), Green (GN).
- Application: Cord and cable management (UTP/STP/FIBER), wire harnesses, prevent interruption to transmission speed when using traditional Nylon cable ties. Reusable and easy to install.

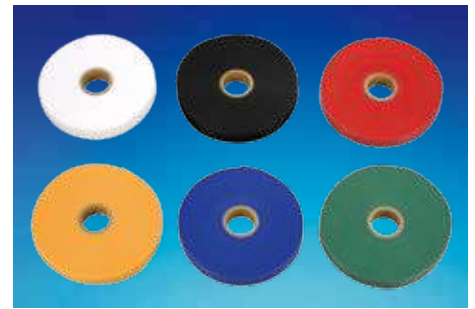
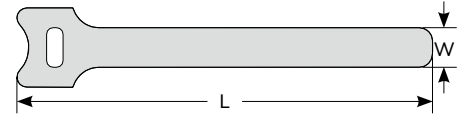

Item No.	Length		W mm	Max. Bundle Dia. mm	Color	Packing
	mm	inch				
MGT-125	125	5"	12	30	BK WE RD YW BE GN	20pcs
MGT-135	135	5 5/16"	12	33		
MGT-150	150	6"	12	36		
MGT-150M	150	6"	10	36		
MGT-180	180	7"	12	40		
MGT-210	210	8 1/4"	16	50		
MGT-240	240	9 7/16"	16	65		
MGT-310	310	12"	16	85		

Item No.	W	Color	Packing
	mm		
MGTP-15	15	BK , WE , RD	10M/Roll
MGTP-20	20	YW , BE , GN	3M/Roll is available upon request

# 0351 KSS MAGIC TIES WITH PLASTIC BUCKLE

- Material: Nylon hook and loop, and plastic buckle made by POM.
- Color: Black (Colors available upon request).
- Application: Cord and cable management (UTP/STP/FIBER), reusable and easy to install.



Item No.	Length		L1 mm	L2 mm	W mm	Packing
	mm	inch				
MGL-330	340	13 1/2"	15	100	20	10pcs
MGL-600M	596	23 5/8"	14	75	15	
MGL-600	595	23 5/8"	15	75	20	

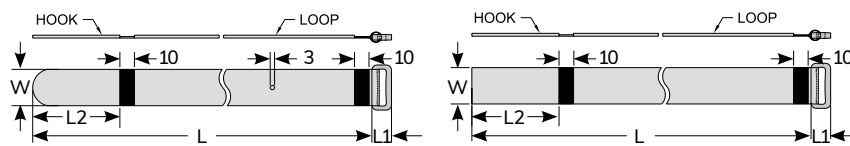

# 0352 KSS MAGIC TIES WITH METAL BUCKLE

- Material: Nylon hook and loop, and metal buckle made by nickel-plated iron.
- Color: Black (Colors available upon request).
- Application: Cord and cable management (UTP/STP/FIBER), reusable and easy to install.



Item No.	Length		L1 mm	L2 mm	W mm	Packing
	mm	inch				
MTL-150	153	6"	9	60	16	10pcs
MTL-200	202	8"	9	60	16	
MTL-250	252	10"	9	75	20	
MTL-300	302	11 7/8"	10	90	25	
MTL-500	502	19 11/16"	11.2	150	38	
MTL-500L	502	19 11/16"	11.8	150	50	
MTL-700	702	27 9/16"	11.8	210	50	

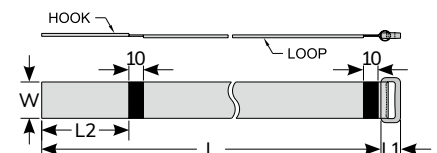

# 0361 KSS COATED COPPER TUBE CABLE TIE

- Material: PE.
- Color: Natural
- Function: Used for coated copper tube in air conditioning system.
- Feature: L shape design suitable for tying wires.

Item No.	Length		W	Max. Bundle Dia.	Packing
	mm	inch			
AT-250	235	9 1/4"	20	65	100pcs
AT-290	275	10 13/16"	20	75	

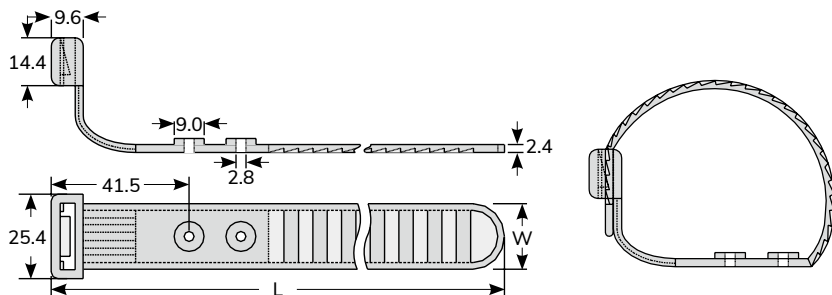

Wiring Ducts

Cable Markers

Cable Ties

Wrapping Bands

Cable Clamps & Tie Mounts

# 0365 KSS CABLE TIE WITH DECORATION TAG



- Material: UL94V-2 flame rated, UL approved Nylon 66.
- Function: Use for decoration when bundling wires, DIY as stationery, gift, packaging material, labeling, etc. It can show your personal style.
- Features: TAIWAN EXCELLENCE 2015 awarded product.
  1. Exchangeable decoration tags.
  2. Exchanging decoration tag by a simple rotation.
  3. Releasable, reusable and environment friendly.
- ※ Special color, length, design, package available on request.

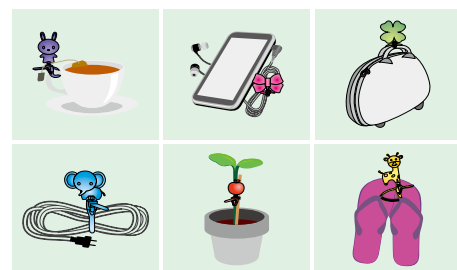

Item No.	Cable Tie Length mm	Content/Color		Packing
PVF150C-20	150	Clover/Neon Green	Apple/Neon Green	20 pcs / Box 2 pcs / type
		Heart/Pink	Ribbon/Pink	
		Butterfly/Yellow	Star/Yellow	
		Flower/Neon Orange	Giraffe/Neon Orange	
		Rabbit/Blue	Elephant/Blue	

Glands, Bushings

Conduits

Bushings

Wire Connectors

Tubes

Cable Clips

PCB Parts

Fasteners

## 0365 KSS CABLE TIE WITH 360 DEGREE ROTATION TAG



- Material: UL94V-2 flame rated, UL approved Nylon 66.
  - Function: Use for decoration when bundling wires, DIY as stationery, gift, packaging material, labeling, etc. It can show your personal style.
  - Features:
    1. Exchangeable decoration tags.
    2. 360 degree rotatable tag can exchange by pulling & plugging.
    3. Releasable, reusable and environment friendly.
- ※ Special color, length, design, package available on request.



Item No.	Cable Tie Length	Content/Color		Packing
	mm			
PVA150C-20	150	Butterfly/Pink	Giraffe/Neon Orange	20 pcs / Box 5 pcs / type
		Rabbit/Neon Green	Elephant/Blue	

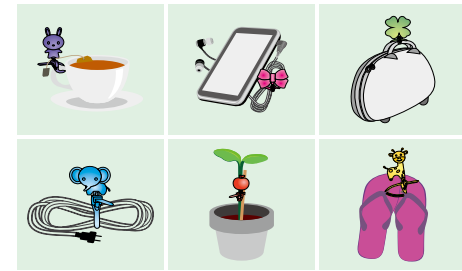

## 0365 KSS HOOK TIE



- Material: UL94V-2 flame rated, UL approved Nylon 66.
  - Function: Using it in your kitchen, bathroom or bedroom, even on your baby stroller, convenient for bundling and hanging stuff.
  - Features: TAIWAN EXCELLENCE 2017 awarded product.
    1. Two-directions hook tie.
    2. 360 degree rotatable hook fits any direction.
    3. Releasable, reusable and environment friendly.
    4. The load is up to 1.5Kgf proved by SGS laboratory.
- ※ Special color, length, design, package available on request.



Item No.	Cable Tie Length	Content/Color	Packing
	mm		
DP-2-A05NYW	150	Star / Yellow	2 pcs / Bag
DP-2-A06PK		Flower / Pink	
DP-2-A11NOE		Ribbon / Orange	
DP-2-A02NGN3		Clover / Green	



Film



# 0365 KSS LUGGAGE TIE



- Material: UL94V-2 flame rated, UL approved Nylon 66.
- Function: Using it on luggage or backpacks helping you carry more extra bags when traveling, or other application you can image.
- Features: TAIWAN EXCELLENCE 2017 awarded product.
  1. Cultural theme: cable tie with Taiwan design.
  2. Double lock. Multi-function.
  3. Releasable, reusable and environment friendly.
  4. Hanging bags on luggage or backpacks easily.
  5. The load is up to 20Kgf proved by SGS laboratory.
- ※ Special color, length, design, package available on request.



Item No.	L1		L2		W	Color	Content	Packing
	mm	inch	mm	inch				
NEW DP-2-DE1BK	150	6"	200	8"	4.8	Black	Taiwan	2 pcs / Bag
DP-2-DE1NGN3						Green		

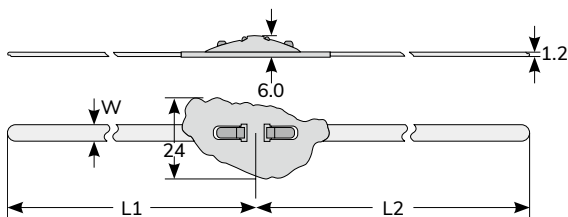

Film

Wiring Ducts

Cable Markers

Cable Ties

Wrapping Bands

Cable Clamps & Tie Mounts

Glands, Bushings

# 0370 KSS STAINLESS STEEL CABLE TIE



- Material : Stainless Steel 316 or 304.
- Suit for engineering, aviation, ship area.
- Feature: Fast locking function, can be quick & easy installed. Designed for indoor and outdoor, Apply for severe environment like high-humidity, high-temperature, chemically, and coldness conditions.
- ※ Other sizes available upon request.

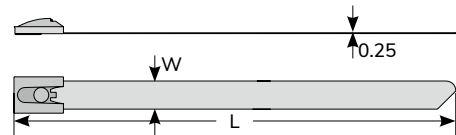
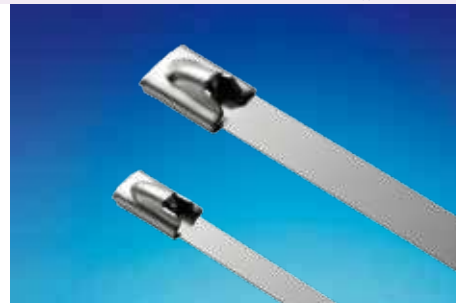

(Refer to P.71)

Item No.		Length		W	Min. Loop Tensile Strength	Max. Bundle Dia.	Packing
316	304	mm	inch				
BST-127	BCT-127	127	5"	4.6	100	25	100pcs
BST-152	BCT-152	152	6"	4.6	100	33	
BST-201	BCT-201	201	8"	4.6	100	51	
BST-266	BCT-266	266	10 1/2"	4.6	100	69	
BST-300	BCT-300	300	11 7/8"	4.6	100	80	
BST-362	BCT-362	362	14 1/4"	4.6	100	102	
BST-521	BCT-521	521	20 1/2"	4.6	100	152	
BST-679	BCT-679	679	26 3/4"	4.6	100	203	50pcs
BST-838	BCT-838	838	33"	4.6	100	254	
BST-127L	BCT-127L	127	5"	7.9	250	25	100pcs
BST-152L	BCT-152L	152	6"	7.9	250	33	
BST-201L	BCT-201L	201	8"	7.9	250	51	
BST-266L	BCT-266L	266	10 1/2"	7.9	250	69	
BST-300L	BCT-300L	300	11 7/8"	7.9	250	80	
BST-362L	BCT-362L	362	14 1/4"	7.9	250	102	
BST-521L	BCT-521L	521	20 1/2"	7.9	250	152	
BST-679L	BCT-679L	679	26 3/4"	7.9	250	203	50pcs
BST-838L	BCT-838L	838	33"	7.9	250	254	

Conduits

Bushings

Wire Connectors

Tubes

Cable Clips

PCB Parts

Fasteners

## 0372 KSS LADDER TYPE STAINLESS STEEL TIE WITH FULLY COATING

- Material: Stainless Steel 316 with Nylon11 coating.
  - Suit for engineering, aviation, ship area.
  - Feature: Quick to fasten and adjustable length. Fast and easy application. Special Nylon11 coating to make stainless steel cable tie more abrasion resistance, weather resistance, impact resistance.
- ※ Other sizes available upon request.

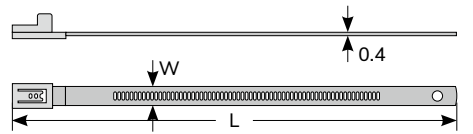

Item No.	Length		W mm	Max. Bundle Dia. mm	Packing
	mm	inch			
ASTN-150	150	6"	7	35	100 pcs
ASTN-195	195	7 11/16"	7	49	
ASTN-225	225	9"	7	58	
ASTN-255	255	10"	7	68	
ASTN-300	300	11 7/8"	7	82	
ASTN-335	335	13 3/16"	7	93	
ASTN-375	375	14 3/4"	7	106	
ASTN-450	450	17 3/4"	7	130	
ASTN-610	610	24"	7	181	
ASTN-150L	150	6"	12	35	
ASTN-195L	195	7 11/16"	12	49	
ASTN-225L	225	9"	12	58	
ASTN-255L	255	10"	12	68	
ASTN-300L	300	11 7/8"	12	82	
ASTN-335L	335	13 3/16"	12	93	
ASTN-375L	375	14 3/4"	12	106	
ASTN-450L	450	17 3/4"	12	130	
ASTN-610L	610	24"	12	181	

## 0373 KSS RELEASABLE STAINLESS STEEL TIE WITH FULLY COATING

- Material: Stainless Steel 316 with Nylon11 coating.
  - Suit for engineering, aviation, ship area.
  - Feature: Quick Fastening and re-used. Fast and easy application. Special Nylon11 coating to make stainless steel cable tie more abrasion resistance, weather resistance, impact resistance.
- ※ Other sizes available upon request.

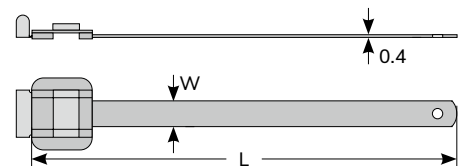

Item No.	Length		W mm	Max. Bundle Dia. mm	Packing
	mm	inch			
RSTN-152	152	6"	6.3	35	50 pcs
RSTN-229	229	9"	6.3	60	
RSTN-305	305	12"	6.3	84	
RSTN-457	457	18"	6.3	132	
RSTN-610	610	24"	6.3	181	
RSTN-152L	152	6"	9.5	35	
RSTN-229L	229	9"	9.5	60	
RSTN-305L	305	12"	9.5	84	
RSTN-457L	457	18"	9.5	132	
RSTN-610L	610	24"	9.5	181	

# Wrapping Bands

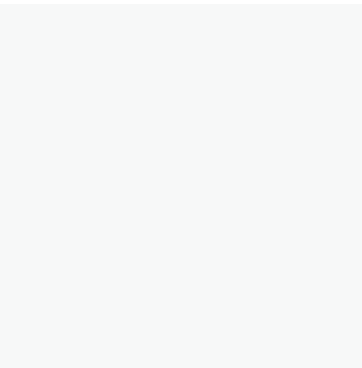
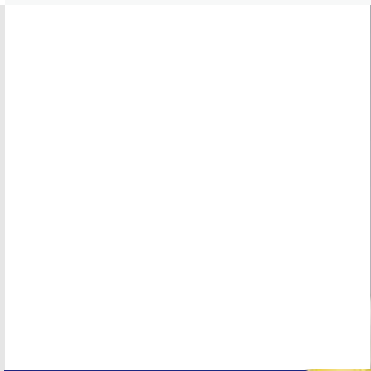
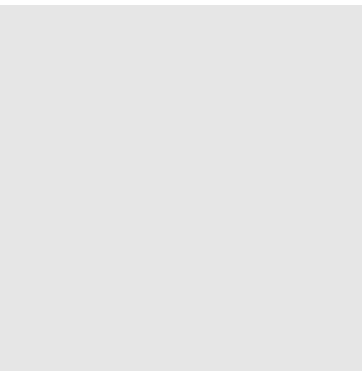
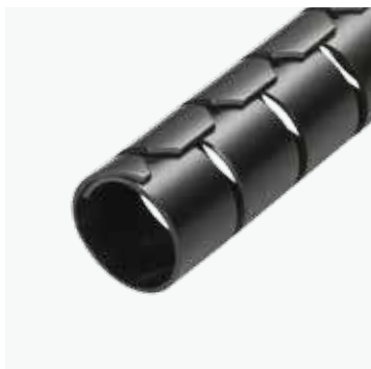

Wiring Ducts
Cable Markers
Cable Ties
<b>Wrapping Bands</b>
Cable Clamps & Tie Mounts
Glands, Bushings
Conduits
Bushings
Wire Connectors
Tubes
Cable Clips
PCB Parts
Fasteners

# 0401 KSS SPIRAL WRAPPING BAND

- Color: Standard in natural. Black and other colors are available upon request.
- Description:
  1. Flexible construction enable bands to follow wire ways easily.
  2. Durable, reusable with retained spiral strength.
  3. Fix ends of band with KSS cable ties and spiral wire bundles in clockwise direction to complete works.
  4. Expand spiral range almost without limit. An economical way of cable binding. Easily applied to electric harness, cables and wire bundles. Cut-to-fit versatility in convenient roll-form.
- A reverse design is available.



## ◆ PE

UNIT : mm

Item No.		O.D.	T	W	Wrapping Range	Packing
Natural	Black					
KS-3	KS-3BK	3.0	0.5	4.7	1.5~10	10M / Bag
KS-6	KS-6BK	4.5	0.6	6.7	2.5~15	
KS-6L	KS-6LBK	6.0	0.6	7.4	4~25	
KS-6.5	KS-6.5BK	6.5	0.55	7.9	5~25	
KS-8	KS-8BK	8.0	0.75	12.0	6~30	
KS-10	KS-10BK	10.0	0.8	12.3	7.5~30	
KS-12	KS-12BK	12.0	0.85	15.0	9~32	
KS-15	KS-15BK	15.0	1.0	15.5	12~35	
KS-19	KS-19BK	19.0	1.2	19.2	15~50	
KS-24	KS-24BK	24.0	1.3	21.5	20~100	
<b>NEW</b> KS-32	KS-32BK	32.0	1.5	25.0	28~120	

## ◆ PE / BOX PACK

Item No.	O.D.	T	W	Wrapping Range	Packing (Box)
<b>NEW</b> KS-8-400M	8.0	0.75	12.0	6~30	400M
<b>NEW</b> KS-10-250M	10.0	0.8	12.3	7.5~30	250M
<b>NEW</b> KS-12-170M	12.0	0.85	15.0	9~32	170M
<b>NEW</b> KS-15-120M	15.0	1.0	15.5	12~35	120M
<b>NEW</b> KS-19-80M	19.0	1.2	19.2	15~50	80M
<b>NEW</b> KS-24-50M	24.0	1.3	21.5	20~100	50M

## ◆ PE / SPOOL PACK

Item No.	O.D.	T	W	Wrapping Range	Packing
KSP-3	3.0	0.5	4.7	1.5~10	100 FT (30.5M) / Roll
KSP-6	4.5	0.6	6.7	2.5~15	
KSP-6L	6.0	0.6	7.4	4~25	
KSP-6.5	6.5	0.55	7.9	5~25	
KSP-8	8.0	0.75	12.0	6~30	
KSP-10	10.0	0.8	12.3	7.5~30	
KSP-12	12.0	0.85	15.0	9~32	
KSP-15	15.0	1.0	15.5	12~35	
KSP-19	19.0	1.2	19.2	15~50	
KSP-24	24.0	1.3	21.5	20~100	

## ◆ NYLON 6 (UL 94HB)

Item No.	O.D.	T	W	Wrapping Range	Packing
KS-6N6	4.5	0.45	8.0	4~25	10M / Bag
<b>NEW</b> KS-6LN6	6.0	0.52	8.0	4~25	
KS-6.5N6	6.5	0.55	7.4	5~25	
KS-8N6	8.0	0.7	12.0	6~30	
KS-10N6	10.0	0.7	12.5	7.5~30	
KS-12N6	12.0	0.7	16.0	9~32	
KS-15N6	15.0	0.8	16.8	12~35	
KS-19N6	19.0	0.9	19.4	15~50	
KS-24N6	24.0	0.9	20.5	20~100	

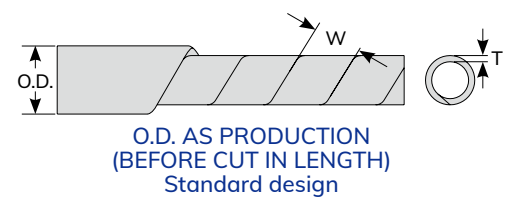

# 0401 KSS SPIRAL WRAPPING BAND



- Material: HDPE.
- Color: Yellow, other colors are available upon request.
- Description:
  1. Flexible construction enable bands to follow wire ways easily.
  2. Durable, reusable with retained spiral strength.
  3. Fix ends of band with KSS cable ties and spiral wire bundles in clockwise direction to complete works.
  4. Expand spiral range almost without limit. An economical way of cable binding. Easily applied to electric harness, cables and wire bundles. Cut-to-fit versatility in convenient roll-form.
- A reverse design is available.

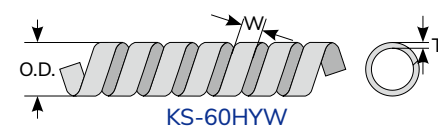
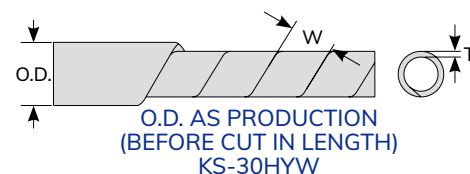

## ◆ HDPE

UNIT : mm

Item No.	O.D.	T	W	Wrapping Range	Packing
KS-30HYW	33.0	2.5	41.0	26~50	2M / pcs
KS-60HYW	60.0	2.5	27.0	60~80	

Wiring Ducts

Cable Markers

Cable Ties

Wrapping Bands

Cable Clamps & Tie Mounts

Glands, Bushings

Conduits

Bushings

Wire Connectors

Tubes

Cable Clips

PCB Parts

Fasteners

# 0401 KSS DOUBLE LAYER SPIRAL WRAPPING BAND



- Material: HDPE.
- Color: Yellow.
- Application: Two layers design, insert wires directly without separation of these layers to get protection.
- Function: Protect wire/cable from damage, ensure a better insulation.
- Feature: Double layers design with outer layer in counterclockwise cut and inner in clockwise, no wires to be exposed and get abrasion in bending.



UNIT : mm

Item No.	O.D. 1	T1	W1	O.D. 2	T2	W2	Wrapping Range	Packing
DKS-37HYW	37.0	2.0	40.0	33.0	1.9	40.0	26	2 M / pcs

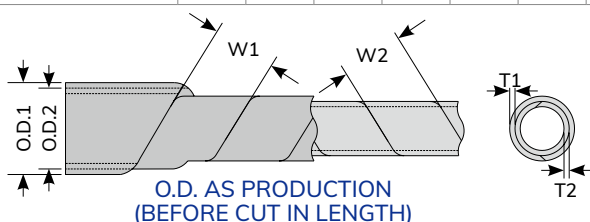

# 0402 KSS SPLIT WRAPPING BAND



- Material : PP, PE.
- Color : Black, other color available upon request.
- Application :
  1. Cut into suitable length, and use the special tool to wrap band the wire easily.
  2. Hold the topside of wire with installation tool, and draw down to wrap the wire immediately by easy and fast.
  3. This wire band designed to be easy off and re-usable, the tensile power will be remain after every wrap and peel.
- Easily applied and safety to protect cables and wire bundles from damage and electric harmless.

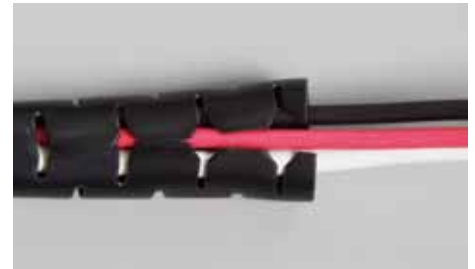

◆ PP UNIT : mm

Item No.	O.D.	T	W	Wrapping Range	Packing
KL-8BK	8	0.85	9	10	5M / Roll / Bag
KL-15BK	15	0.85	13	16	
KL-20BK	20	0.95	15	22	
KL-25BK	25	1.05	18	27	
KL-32BK	32	1.30	23	35	

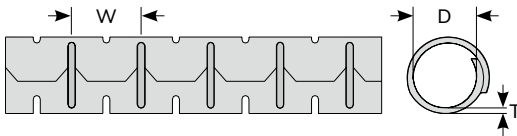

◆ PE

Item No.	O.D.	T	W	Wrapping Range	Packing
<b>NEW</b> KL-5PE	5.5	0.70	10.0	6.5	5M / Roll / Bag

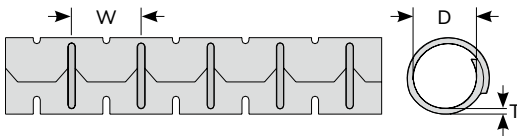

# 0402 KSS SPLIT WRAPPING BAND INSTALLATION TOOL



- Material : PP.
- Color : Black.

UNIT : mm

Item No.	D	To Be Used With	Packing
<b>NEW</b> KT-5BK	5	KL-5PE	10 pcs / Bag
KT-8BK	8	KL-8BK	
KT-15BK	15	KL-15BK	
KT-20BK	20	KL-20BK	
KT-25BK	25	KL-25BK	
KT-32BK	32	KL-32BK	

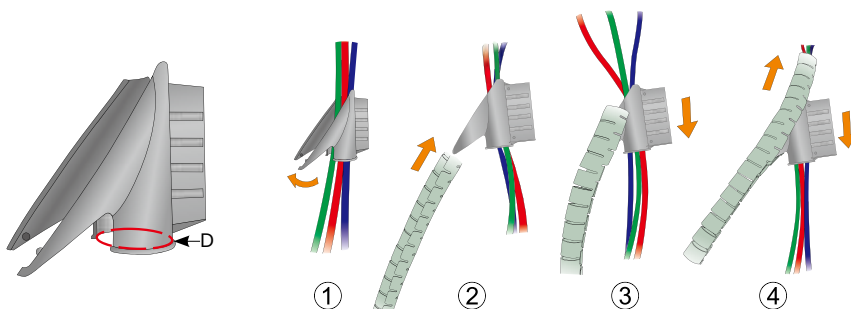

# 0403 KSS WRAPPING BAND



- Material : UL94VTM-0 flame rated PVC.
- Application:
  1. Good for cable wrapping.
  2. Easy to wrap, re-usable.

## ◆ Button Type

UNIT : mm

Item No.		Packing (Spool)	Item No.		Packing (Spool)	Button Distance	Max. Bundle Dia.
Grey	Black/Grey		Grey	Black/Grey			
WB-40	WBS-40	55M / RL	<b>NEW</b> WB-40-10M	WBS-40-10M	10M / Bag	40	12
WB-47	WBS-47		<b>NEW</b> WB-47-10M	WBS-47-10M		47	15
WB-60	WBS-60		<b>NEW</b> WB-60-10M	WBS-60-10M		60	20
WB-80	WBS-80		<b>NEW</b> WB-80-10M	WBS-80-10M		80	25
WB-100	WBS-100		<b>NEW</b> WB-100-10M	WBS-100-10M		100	30
WB-128	WBS-128		<b>NEW</b> WB-128-10M	WBS-128-10M		128	40
WB-140	WBS-140		<b>NEW</b> WB-140-10M	WBS-140-10M		140	44
WB-150	WBS-150		<b>NEW</b> WB-150-10M	WBS-150-10M		150	47
WB-160	WBS-160		<b>NEW</b> WB-160-10M	WBS-160-10M		160	50
WB-182	WBS-182		<b>NEW</b> WB-182-10M	WBS-182-10M		182	57
WB-222	WBS-222		<b>NEW</b> WB-222-10M	WBS-222-10M		222	70
WB-315	WBS-315		<b>NEW</b> WB-315-10M	WBS-315-10M		315	100
WB-475	WBS-475		<b>NEW</b> WB-475-10M	WBS-475-10M		475	150



cut-to-fit versatility in convenient roll-form

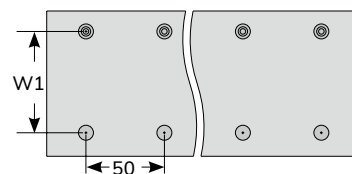

WB、WBS

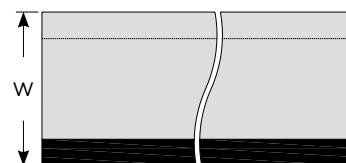

WBT

## ◆ Tape Type

Item No.	Packing (Spool)	Item No.	Packing (Spool)	Band width	Max. Bundle Dia.
WBT-48	55M / RL	<b>NEW</b> WBT-48-10M	10M / Bag	48	9
WBT-63		<b>NEW</b> WBT-63-10M		63	15
WBT-84		<b>NEW</b> WBT-84-10M		84	20
WBT-100		<b>NEW</b> WBT-100-10M		100	25
WBT-115		<b>NEW</b> WBT-115-10M		115	30
WBT-147		<b>NEW</b> WBT-147-10M		147	40
WBT-183		<b>NEW</b> WBT-183-10M		183	50
WBT-246		<b>NEW</b> WBT-246-10M		246	70
WBT-340		<b>NEW</b> WBT-340-10M		340	100

# 0405 KSS BINDING BAND



- Material : PVC, PE.
- Used for fastening or supporting cable, pipe, wire bundles, wire harness.
- Low cost for permanent application. Button up band is all.

UNIT : mm

Item No.	W	Material	Packing
A-6	6	PVC	10M / Bag
A-8	8		
A-10	10		
A-12	12		
A-6B	Buttons For Band	PE	100pcs / Bag
A-8B			
A-10B			
A-12B			

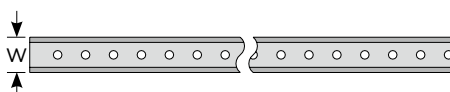

## 0410 KSS BINDING BAND

- Material: PVC.
- Color: Clear.
- Diameter: 1mm (solid).
- Packing: per bundle.

UNIT : mm

Item No.	Size	Packing
B-1	1.0	1 Bundle (about 350m / bundle )

 Wiring  
Ducts

 Cable  
Markers

 Cable  
Ties

 Wrapping  
Bands

## 0420 KSS TWIST TIE

- Material: Metal wire with PVC or PE coating.
- Application: For wire, bag and garden bundling.
- ※ M-1 with PE coating is RoHS compliant.

### ◆ PVC

Item No.	Color	Packing
M-1BK	Black	1 Kgs / Roll (about 270M / Roll)
M-1BE	Blue	
M-1GN	Green	
M-1RD	Red	
M-1WE	White	
M-1YW	Yellow	



### ◆ PE (RoHS compliant)

Item No.	Color	Packing
M-1PEBK	Black	400 M / Roll
M-1PEWE	White	

 Cable Clamps  
& Tie Mounts

 Glands,  
Bushings

Conduits

Bushings

 Wire  
Connectors

## 0425 KSS SNAP BAND

- Material: UL94V-2 flame rated, UL approved Nylon 66.
- Color : Black, available in natural or other colors.

UNIT : mm

Item No.	Size	Packing
SNB-03	As Figure	100pcs

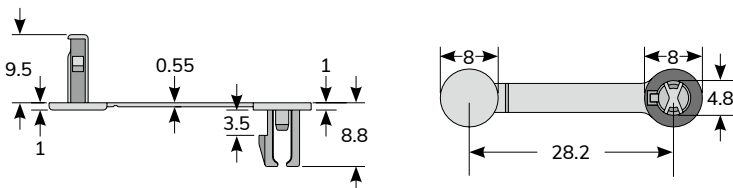

Tubes

 Cable  
Clips

 PCB  
Parts

Fasteners



# Cable Clamps & Tie Mounts

Wiring Ducts

Cable Markers

Cable Ties

Wrapping Bands

Cable Clamps & Tie Mounts

Glands, Bushings

Conduits

Bushings

Wire Connectors

Tubes

Cable Clips

PCB Parts

Fasteners

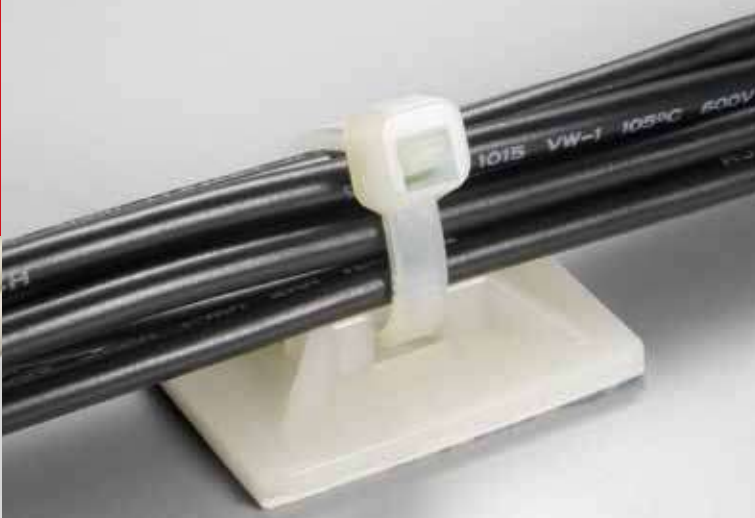

# 0501 KSS CABLE CLAMP

- Material: UL94V-2 flame rated, UL approved Nylon 66.
- Color : Natural, available in other colors.
- KSS CABLE CLAMPS are designed to hold cables, tubes, and components in domestic appliance, electronics and electric apparatus generally.
- Interior edges are radiused to protect cable insulation.
- To apply, just clamp down on loosen cables and screw it to chassis.

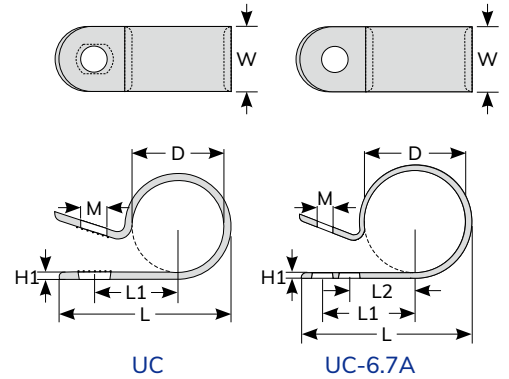

UNIT : mm

Item No.	L	L1	W	H1	M	Bundle dia.	Packing
UC-0	16.9	8.0	9.6	1.05	4.8	3.1 (1/8")	100pcs
UC-0.5	18.5	9.2	9.6	1.05	4.8	5.0 (3/16")	
UC-1	20.0	10.4	10.1	1.1	4.6	6.35 (1/4")	
UC-1.5S	22.6	11.2	10.0	1.15	4.8	7.2 (9/32")	
UC-1.5	22.6	11.2	10.0	1.15	5.0	7.9 (5/16")	
UC-2	26.6	12.5	12.3	1.4	5.0	9.5 (3/8")	
UC-3	30.3	14.8	12.2	1.4	5.0	12.7 (1/2")	
UC-4	32.6	15.8	12.4	1.4	5.0	15.8 (5/8")	
UC-5	37.3	18.0	11.8	1.4	4.8	19.4 (3/4")	
NEW UC-5.5	40.4	21.9	13.0	1.4	5.5	22.2 (7/8")	
UC-6	43.4	21.0	12.0	1.4	5.0	25.4 (1")	
UC-6.5	51.5	26.0	12.6	1.7	4.8	27.5 (1 1/16")	
UC-7	52.3	26.0	12.0	1.6	4.7	31.8 (1 1/4")	
UC-9	58.3	27.8	12.5	1.5	4.8	36.7 (1 1/2")	

Item No.	L	L1	L2	W	H1	M	Bundle dia.	Packing
UC-6.7A	47.0	25.6	17.2	13.0	1.5	5.4	22.8~28.5 (7/8") ~ (1 1/8")	100pcs

# 0502 KSS ADJUSTABLE CABLE CLAMP

- Material: UL94V-2 flame rated, UL approved Nylon 66.
- Color : Natural, available in other colors.
- Feature : Oval hole design for adjustable of bundling size.



UNIT : mm

Item No.	L	L1	W	M	Bundle dia.	Packing
PC-0406	23.5	10.4	13	5	4.8~6.4	100pcs
PC-0609	30.5	16.1	13	5	6.7~9.5	
PC-0914	40.0	20.7	13	5	9.5~14.3	

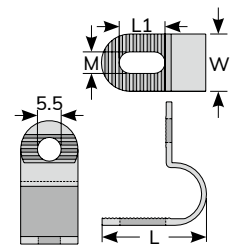

# 0503 KSS CABLE CLAMP

- Material: UL94V-2 flame rated, UL approved Nylon 66.
- Color : Natural, available in other colors.



UNIT : mm

Item No.	L	L1	W	H1	M	Bundle dia.	Packing
KUC-5	20	11.6	8.5	1.3	4.4	5	100pcs

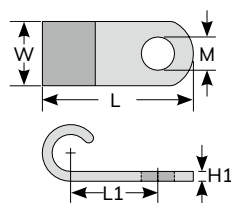

# 0505 KSS SELF ADHESIVE TIE MOUNT

- Material: UL94V-2 flame rated, UL approved Nylon 66 with adhesive tape.
- Color : Natural, available in other colors.
- SELF-ADHESIVE TIE MOUNT is designed to support light weight wire bundles when properly applied on any clean, smooth, grease-free surface. For heavy support, mounting hole is provided for screws.
- To apply, simply peel off liner and apply mount to surface. After that, cable ties can be inserted to secure wire bundles.

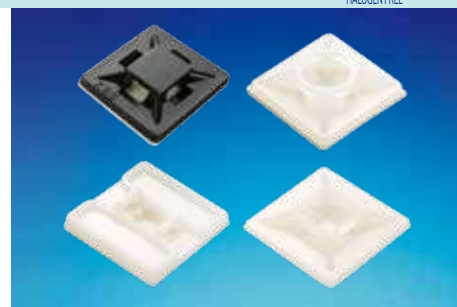

UNIT : mm

Item No.	L	W	W1	H	Mounting Hole M	Packing
※ ▲ HC-100-S4	12.5	12.5	3.2	3.2		100pcs
※ ▲ HC-101S-S2	19.5	19.5	4.6	3.9	3.2	
▲ HC-101S	19.5	19.5	4.6	3.9	3.2	
▲ HC-101	21.8	21.8	4.8	4.0		
NEW ▲ HC-101SA	19.0	19.0	4.0	4.5	3.4	
▲ HC-102	28.6	28.6	5.5	5.3	5.0	
NEW ▲ HC-102A	28.0	28.0	5.3	5.6	5.6	
HC-103	29.2	29.2	5.5	5.4	5.0	
▲ HC-25	26.1	26.1	8.0	6.0	4.3	
▲ HC-19R	18.9	18.9	4.2	4.6	4.8	
▲ HC-26R	26.3	26.3	5.6	6.0	5.0	
HC-18T	19.0	19.0	4.1	5.0	4.4	
HC-26T	26.5	26.5	5.8	7.4	4.3	
▲ HC-3838	38.5	38.5	10.2	7.6	5.0	

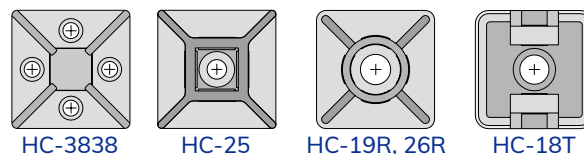
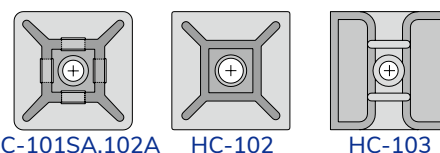
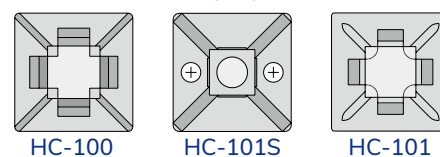
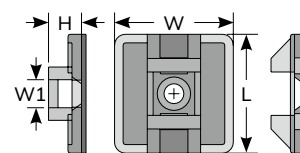

- ※ HC-100-S4 4pcs on a strip (Simply peel off backing paper)
- ※ HC-101S-S2 2pcs on a strip (Simply peel off backing paper)
- ▲ 4 way entry

# 0510 KSS SADDLE TYPE TIE MOUNT

- Material: UL94V-2 flame rated, UL approved Nylon 66.
- Color : Natural, available in other colors.
- Saddle design provides maximum stability to wire bundles.
- To apply, simply fix mount with a screw and secure wire bundles with KSS nylon cable ties.



UNIT : mm

Item No.	L	W	W1	H	Mounting Hole M	Packing
HC-0	19.6	9.5	5.2	5.0	3.7	100pcs
HC-0M	19.0	9.5	5.0	5.0	4.3	
HC-0L	19.0	9.5	5.0	5.0	5.2	
HC-0R	19.1	10.0	5.4	6.2	4.2	
HC-1	15.0	10.0	5.1	7.0	3.5	
HC-1S	12.8	7.0	4.0	5.8	3.3	
HC-2S	23.0	16.0	9.0	9.8	5.0	
HC-2	23.0	16.0	9.0	9.8	6.3	
HC-2A	20.5	17.1	10.4	10.4	6.0	
HC-2L	23.0	16.0	9.0	9.8	6.5	
HC-3	23.0	13.8	9.5	17.5	5.3	
HC-4	30.0	14.7	9.3	11.6	5.0	
※ HC-5	21.5	16.0	7.8	10.0	9.7X5.8	

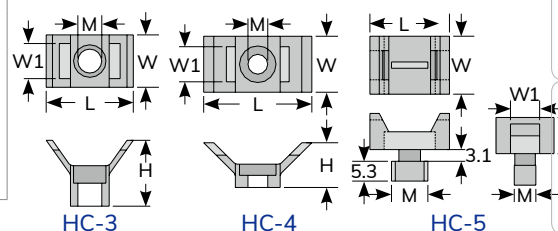
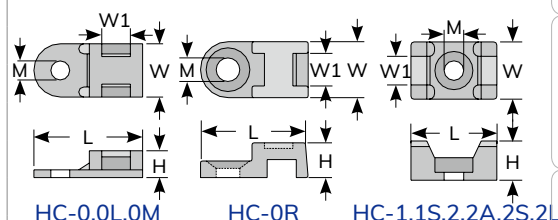

- ※ HC-5 is applied by installing into a mounting hole and rotating to secure it.

# 0511 KSS WALL PLUG MOUNT

- Material: UL94V-2 flame rated, UL approved Nylon 66.
- Color : Black, available in natural or other colors.

UNIT : mm

Item No.	Dimension			Mounting Hole	Packing
	W1	H1	H2		
CH-5	5.8	6.1	24.4	5	100pcs
CH-6	9.9	6.3	24.7	6	
<b>NEW</b> CH-6A	5.8	6.0	24.7	6	
<b>NEW</b> CH-7	9.8	6.3	31.5	7	
CH-8	9.7	6.3	37.5	9	
<b>NEW</b> CH-8A	10.0	6.1	34.1	8	
CH-8H	9.4	5.9	36.0	9	
CH-9	9.7	13.0	36.2	9	
CH-9H	9.6	15.2	36.1	9	

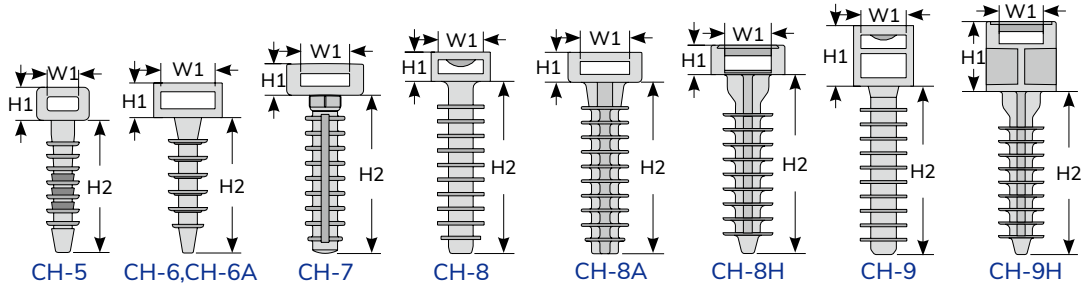
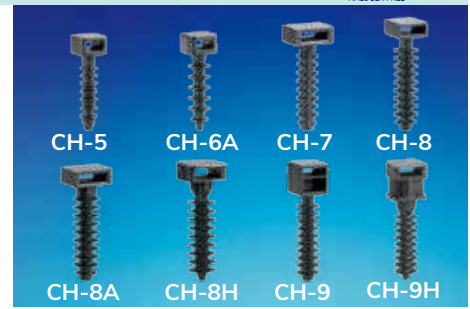

# 0511 KSS WALL PLUG

- Material: UL94V-2 flame rated, UL approved Nylon 66.
- Color : Black, available in natural or other colors.
- Drill a hole on the wall with 8mm deep, and screw it with using model no. PMB-145 or PMB-240 together and fix things on the wall easily.

UNIT : mm

Item No.	Dimension		Mounting Hole	Packing
	H1	H2		
CWP-38	6.85	30.65	8.0	100pcs

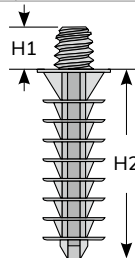

(Refer to P.84)

# 0511 KSS CABLE HOLDER

- Material: PP.
- Easy cable support, use in room and sewer. Screw the holder on wall or ceiling, quick and easy to collect cable.



UNIT : mm

Item No.		L	L1	W	H	H1	M	Packing
Grey	Natural							
CH-7030GY	CH-7030	41.3	29.8	27.5	80.0	69.7	6.4	25PCS
CH-10545GY	CH-10545	62.0	48.3	26.8	120.7	106.5	6.5	10PCS

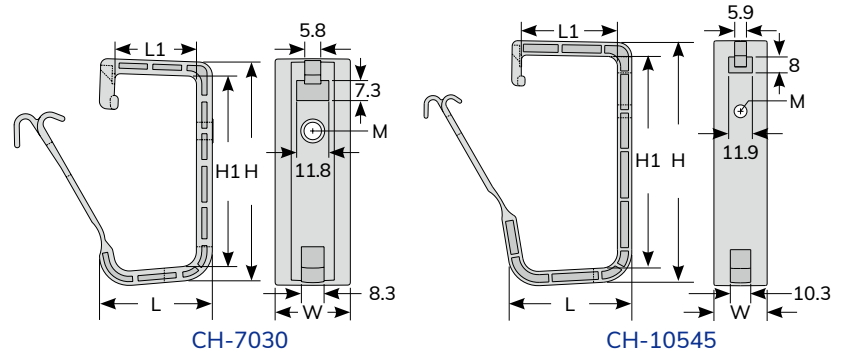

# 0512 KSS PUSH TIE MOUNT

- Material: UL94V-2 flame rated, UL approved Nylon 66.
- Color : Natural, available in other colors.
- Drill hole on board to fix tie mount and then insert tie into the mount for bundling cables.



UNIT : mm

Item No.	W1	Mounting Hole	Chassis Thickness	Packing
PHC-4	3.8	4.8	0.5~1.6	100pcs
PHC-5	5.0	7.0	1.6~4.0	
NEW PHC-5A	5.0	6.3	3.2	
PHC-5L	5.0	7.0	1.6~4.0	
PHC-6.5	6.5	As Figure	3.2	
PHC-8	8.1	6.2	0.5~1.2	
PHC-9	9.4	As Figure	2.0	
PHC-1105	11.0	As Figure	0.5~1.2	
PHC-1509	7.8	6.0	2.0	

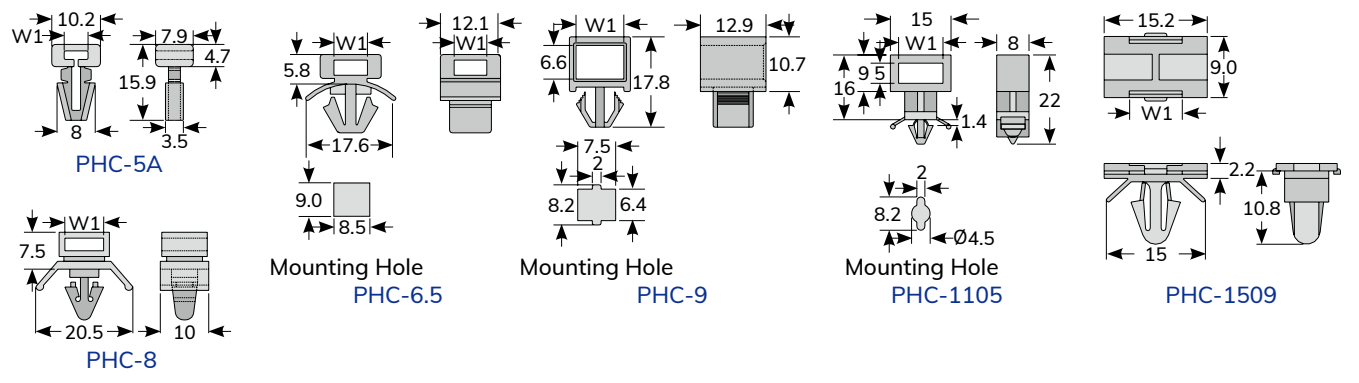
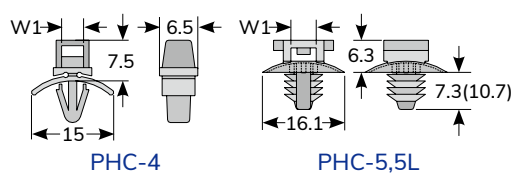

# 0513 KSS TWIN TIE DEVICE

- Material: UL94V-2 flame rated, UL approved Nylon 66.
- Color : Black, available in natural or other colors.
- Twin tie device is ideal to connect, enables cables to be secured to posts or pipes by passing two ties through the rectangular hole.

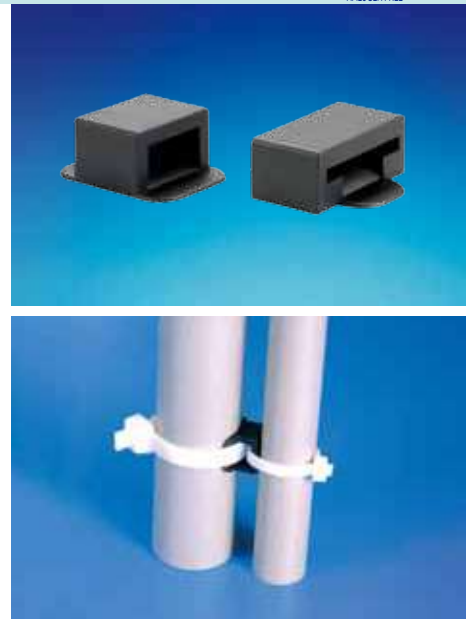

UNIT : mm

Item No.	Dimension				Packing
	L	W	W1	H	
DH-10	21.3	13.9	9.3	9.3	100pcs
DH-11	21.3	15.0	10.5	9.3	
DH-16	20.8	21.4	17.5	8.7	
DH-20	20.8	25.4	21.5	8.7	

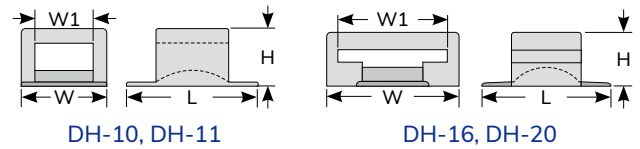

# 0514 KSS LADDER TYPE CABLE HOLDER

- Material: UL94V-2 flame rated, UL approved Nylon 66.
- Color : Black
- Simply fix the holder with a screw and secure wire bundles with cable ties width of up to 4.8mm.



UNIT : mm

Item No.	W1	H	M	Packing
LCH-60BK	5.5	60	6	50pcs
LCH-120BK	5.5	120	6	
LCH-160BK	5.5	160	6	

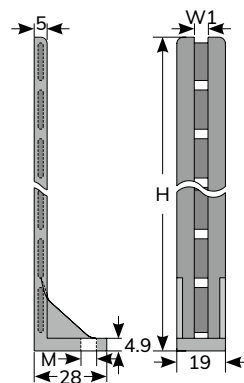

## 0515 KSS SELF-ADHESIVE CABLE CLAMP

- Material: UL94V-2 flame rated, UL approved Nylon 66 with adhesive tape.
- Color : Black
- Backed with a high quality tape. Designed to secure wire bundles where fixing holes are impracticable. Can be quickly applied to almost any clean, smooth and grease-free surface. (Also provided with a mounting hole)

UNIT : mm

Item No.	Dimension						Packing
	L	W	H	H1	M	Bundle Dia.	
4J-S	25.8	13.4	12.2	3.0	5.0	5.5	100pcs
6J-S	28.8	13.4	14.5	3.2	5.0	7.5	
8J-S	34.8	16.5	18.5	3.0	5.3	12.0	
10J-S	36.5	16.4	19.5	3.2	5.0	14.0	
11J-S	38.2	16.0	20.3	2.7	5.0	15.0	
12J-S	41.3	15.6	25.0	3.1	4.8	17.0	

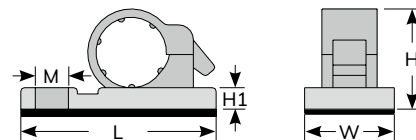

Wiring Ducts

Cable Markers

Cable Ties

Wrapping Bands

Cable Clamps & Tie Mounts

## 0516 KSS PUSH TIE MOUNT

- Material: UL94V-2 flame rated, UL approved Nylon 66.
- Color : Grey, available in natural or other colors.

UNIT : mm

Item No.	L	W	W1	W2	H	Bundle Dia.	Packing
PFS-10	28.4	17.2	14.3	11.9	20.7	10.1	100pcs
PFS-15	31.8	19.3	16.3	14.0	27.1	14.9	
PFS-18	35.0	21.2	18.3	15.9	29.8	17.3	

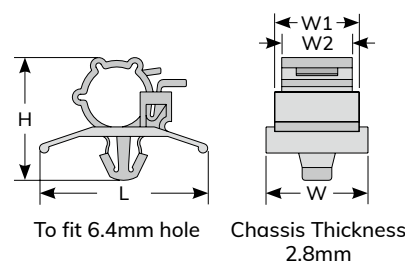

Glands, Bushings

Conduits

Bushings

Wire Connectors

## 0517 KSS ADJUSTABLE CABLE CLAMP

- Material: UL94V-2 flame rated, UL approved Nylon 66 with adhesive tape.
- Color : Black
- One size of adjustable clamp can accommodate various cables.
- Easy to install, open for unlimited usage.

UNIT : mm

Item No.	L	W	W1	H	H1	Bundle Dia.	Packing
AP-0810	25.4	19.1	10.2	22.2	1.6	7.9~10.3	100pcs
AP-1013	31.8	19.1	10.2	27.8	1.6	10.0~12.5	
AP-1316	37.0	18.4	12.1	31.8	3.0	12.6~15.4	
AP-1720	42.0	25.0	12.7	37.0	3.0	16.5~20.1	
AP-2225	41.8	21.5	11.3	43.5	3.0	22.2~25.4	

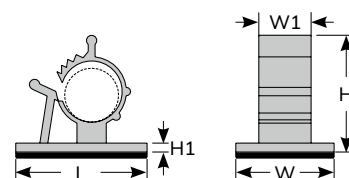
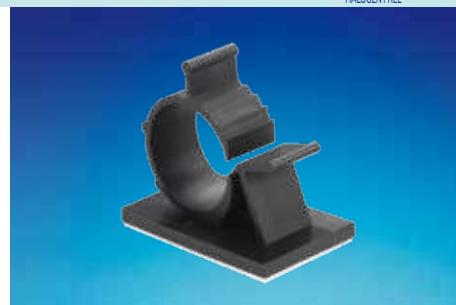

Tubes

Cable Clips

PCB Parts

Fasteners

## 0518 KSS CABLE CLAMP

- Material: UL94V-2 flame rated, UL approved Nylon 66.
- Color : Grey, available in natural or other colors.
- Two stage lock design to accommodate different cable sizes in one clamp.
- Available in both "ADHESIVE TAPE" and "PUSH MOUNT" design.

UNIT : mm

Item No.		L	W	Bundle Dia.	Packing
Adhesive	Push				
TS-0607	PTS-0607	25	20.0	6~7	100pcs
TS-0708	PTS-0708	25	20.0	7~8	
TS-0910	PTS-0910	30	24.5	9~10	
TS-1214	PTS-1214	30	24.5	12~14	
TS-1618	PTS-1618	30	24.5	16~18	

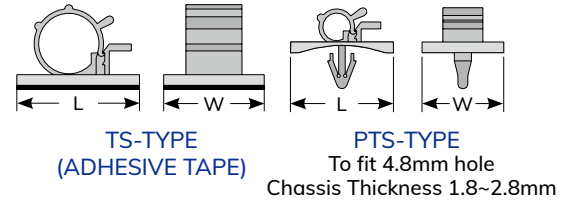

Wiring Ducts

Cable Markers

Cable Ties

Wrapping Bands

Cable Clamps & Tie Mounts

## 0519 KSS ADJUSTABLE CABLE CLAMP

- Material: UL94V-2 flame rated, UL approved Nylon 66 with adhesive tape.
- Color: Natural, available in other colors.
- Application: Peel off the liner and fix the clamp on the dedicated area and put the tie through the slot to secure.
- Feature: Ladder-shape tie good for adjusting the bundle loop.

UNIT : mm

Item No.	L	W	W1	H	M	Max.Bundle Dia.	Packing
ATC-17	25.0	18.0	7.9	70	3.6	17.0	100pcs
ATC-22	30.5	21.0	12.0	90	3.4	22.0	
ATC-26	30.5	21.0	12.0	108	3.4	26.0	

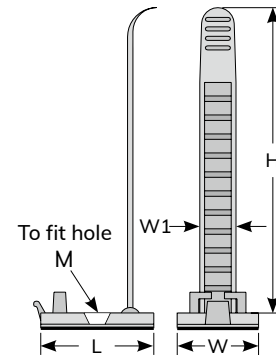

Glands, Bushings

Conduits

Bushings

Wire Connectors

Tubes

## 0521 KSS MOUNTING WIRE CLIP

- Material: UL94V-2 flame rated, UL approved Nylon 66.
- Color: Natural, available in other colors.
- Application: Quick mounting on dedicated area to fix the wires.

UNIT : mm

Item No.	L	L1	W	W1	H	Bundle Dia. H1	Packing
MFC-1002	20.2	9.8	10.2	5.2	6.0	2.2	100pcs

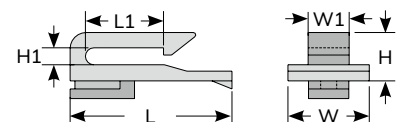

Cable Clips

PCB Parts

Fasteners



# 0520 KSS SELF-ADHESIVE WIRE CLIP

- Material: UL94V-2 flame rated, UL approved Nylon 66 with adhesive tape.
- Color: Natural, available in other colors.
- Application: Peel off the liner and secure the clip on the dedicated area and fix the wires through.



UNIT : mm

Item No.	L	L1	W	W1	H	Bundle Dia. H1	Packing
FC-1	13.0	8.0	9.5	6.5	5.2	2.8	100pcs
FC-2	16.0	4.0	15.5	9.0	6.8	4.0	
<b>NEW</b> FC-2L	16.2	5.1	16.2	10.9	6.2	3.8	
FC-3	16.0	12.5	16.0	7.2	6.8	3.7	
FC-4	27.0	14.8	17.0	7.3	8.7	5.5	
FC-0601	19.1	6.4	12.9		2.2	0.9	
FC-1001	11.9	9.3	6.0		3.5	1.0	
FC-1206	16.0	11.9	15.8	8.9	9.0	5.8	

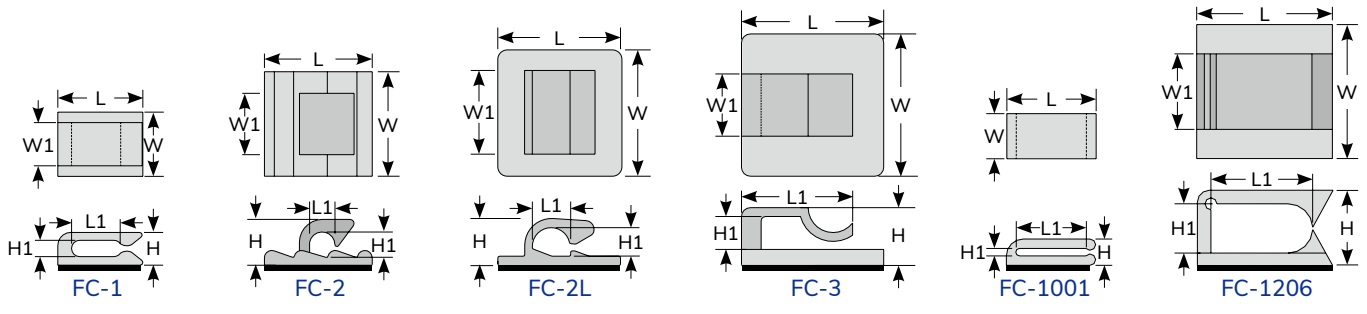
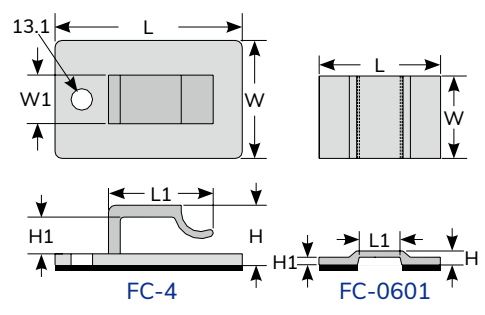

# 0520 KSS SELF-ADHESIVE WIRE CLIP

- Material: UL94V-2 flame rated, UL approved Nylon 66 with adhesive tape.
- Color: Natural, available in other colors.
- Application: Peel off the liner and secure the clip on the dedicated area and fix the wires through.



UNIT : mm

Item No.	L	L1	W	W1	H	Bundle Dia. H1	Packing
FC-0605	19.0	5.9	19.0	10.0	9.1	4.9	100pcs
<b>NEW</b> FC-1207	25.0	11.2	25.0	12.6	10.3	7.0	
FC-1208	26.8	11.9	26.5	12.3	11.7	8.3	
FC-1813	25.6	17.8	25.5	15.8	17.2	13.3	
<b>NEW</b> FC-2012	33.7	20.5	27.5	23.6	16.4	12.8	
FC-2211	33.3	22.2	28.3	18.7	15.2	11.1	

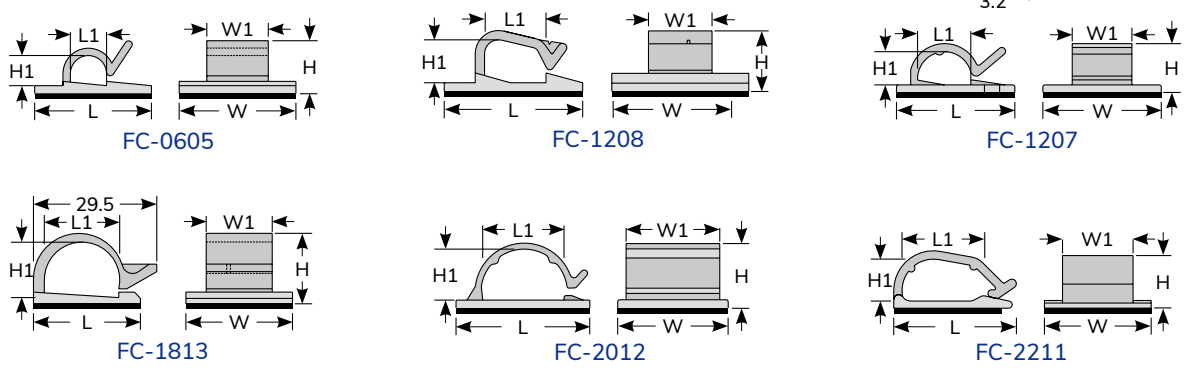
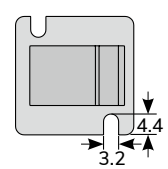

## 0522 KSS WIRE CLIP



- Material: UL94V-2 flame rated, UL approved Nylon 66.
- Color: Natural, available in other colors.
- Application: Drill a hole on wall or board, and knock the clip to fix wires.

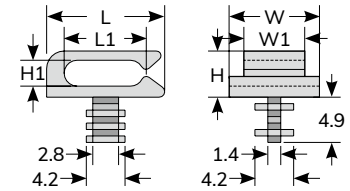

UNIT : mm

Item No.	L	L1	W	W1	H	Bundle Dia. H1	Packing
FC-0903	12.8	8.9	9.8	6.6	5.0	2.8	100pcs

## 0524 KSS WIRE CLIP



- Material: UL94V-2 flame rated, UL approved Nylon 66.
- Color: Natural, available in other colors.
- Application: Fix wires onto the clip and use screw to fix on the chassis.



UNIT : mm

Item No.	L	W	H	Mounting Hole M	Bundle Dia. H1	Packing
WH-4	18.7	12.8	6.0	5.0	4.4	100pcs

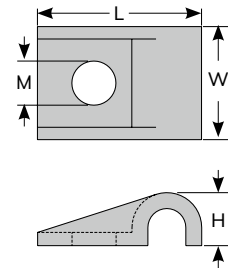

## 0525 KSS CATV SIDING CLIP



- Material: UL94V-2 flame rated, UL approved Nylon 66 with adhesive tape.
- Color: Black
- Designed for installation of (1/4"dia.) RG-59(u) type cable.



UNIT : mm

Item No.	L	W	H	Bundle Dia. D	Packing
CATV-1	21.1	12.8	8.7	5.5	100pcs

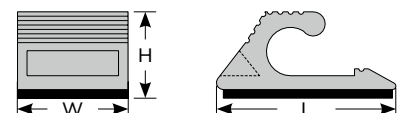

ADHESIVE TAPE

## 0526 KSS SELF-ADHESIVE WIRE CLIP

- Material: PE with adhesive tape.
- Color: White
- Application: Peel off the liner and paste onto the chassis, clip wire on to fix.

UNIT : mm

Item No.	L	W	H	Bundle Dia.	Packing
VC-2	16.5	21.5	6.2	2.8	100pcs

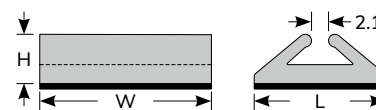

ADHESIVE TAPE

Wiring Ducts

Cable Markers

Cable Ties

Wrapping Bands

## 0526 KSS SELF-ADHESIVE WIRE CLIP

- Material: UL94V-2 flame rated, UL approved Nylon 66 with adhesive tape.
- Color: Natural, available in other colors.
- Feature: Easy peel liner design.
- Application: Peel off the liner and paste onto the chassis, clip wire on to fix.

UNIT : mm

Item No.	L	W	H	Bundle Dia.	Packing
VC-0606	18	8.8	10.7	6.0	100pcs

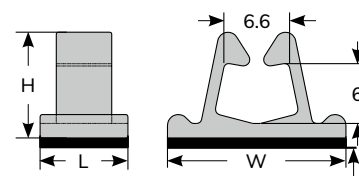

Easy peeling liner

Cable Clamps & Tie Mounts

Glands, Bushings

Conduits

Bushings

Wire Connectors

## 0526 KSS MULTIPLE WIRE CLIP

- Material: UL94V-2 flame rated, UL approved Nylon 66 with adhesive tape.
- Color: Black.
- Application: Peel off the liner paper to fix and hold cable neatly.
- Widely used in home, office, and communication wiring application.
- Feature: Break into pieces needed along the cutting line.

UNIT : mm

Item No.	L	W	H	Bundle Dia.	Packing
SWV-1	86.4	8.8	12.5	7.8	20 strips (6 pcs/strip)

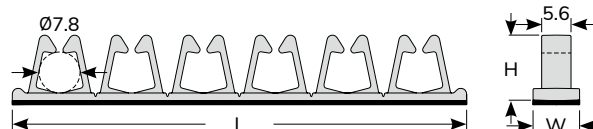

NEW

Cable Clips

PCB Parts

Fasteners

## 0527 KSS CABLE CLAMP

- Material: UL94V-2 flame rated, UL approved Nylon 66.
- Color: Natural, available in other colors.
- Application: Fix clamp onto the chassis and insert the cable, using screw to fix the cables.

UNIT : mm

Item No.	Dimension	Mounting Hole M	Bundle Dia.	Packing
DCC-15	As Figure	3.4	14.7	100pcs

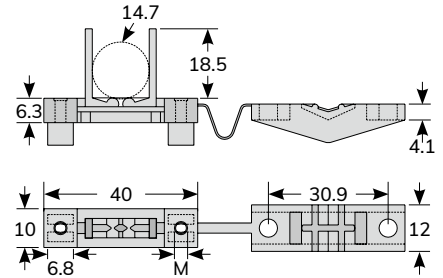

## 0528 KSS CABLE CLAMP

- Material: UL94V-2 flame rated, UL approved Nylon 66.
- Color: Black, available in natural or other colors.
- Application: Insert cables into the clamp and lock it to fix.
- Feature: 1. To tidy the cables.  
2. Suitable for 4mm cable.

UNIT : mm

Item No.	L	L1	Bundle Dia.	Packing
RC-34	14.3	4.1	4.1	100pcs

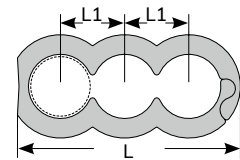

## 0529 KSS SELF-ADHESIVE WIRE CLIP

- Material: UL94V-2 flame rated, UL approved Nylon 66 with adhesive tape.
- Color: White
- Application: Peel off the liner and fix it on the side of table and insert wire.
- Feature: Suitable use in corner place and tidy wires with compartment design.

UNIT : mm

Item No.	L1	L2	H1	Packing
SWC-610	9.2	8.4	11.0	100pcs

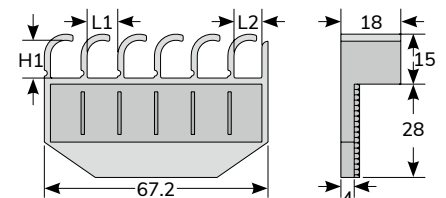
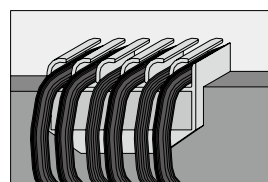

# 0530 KSS FLAT CABLE CLAMP

RoHS

OPTION

- Material: **UL94V-0** and **M1** flame rated, UL approved PVC with adhesive tape.
- Color: Grey
- Conduct your flat cable neatly and firmly.
- Insert your cable into the clamp and your job is done.

Item No.	L	W	H	Packing
FC-15	24	15	9	100pcs
FC-20	24	20	9	
FC-25	24	25	9	
FC-28	24	28	9	
SFC-15	13	15	6	
SFC-20	13	20	6	
SFC-25	13	25	6	
SFC-28	13	28	6	

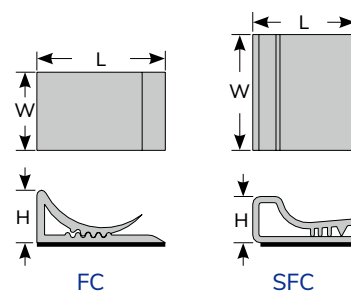
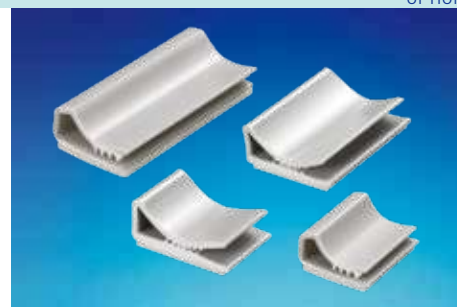

# 0531 KSS CABLE CLAMP

RoHS

OPTION

- Material: **UL94V-0** and **M1** flame rated, UL approved PVC with adhesive tape.
- Color: Grey.
- Feature: Easy peel liner can help to peel off easily.
- Application: Peel off the liner, position on the flat surface then secure the wires or cables.

Item No.	L	W	H	H1	Packing
RCL-12	28.5	25.4	13.8	11.4	100pcs

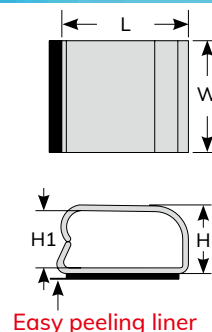

# 0532 KSS CABLE CLAMP

RoHS

OPTION

- Material: **UL94V-0** and **M1** flame rated, UL approved PVC with adhesive tape.
- Color: Grey.
- Application: Peel off the liner, position on the PC board surface then fix the cables.

Item No.	L	L1	W	Packing
CL-15	18.5	16	15	100pcs
CL-20	18.5	16	20	
CL-25	18.5	16	25	
CL-28	18.5	16	28	

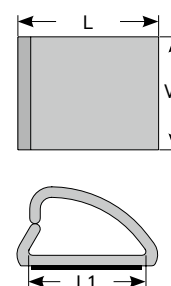

# 0535 KSS FLAT CABLE CLAMP

- Material: UL94V-2 flame rated, UL approved Nylon 66.
- Color: Natural, available in other colors.
- Clamp down ribbon cable by finger pressure.

UNIT : mm

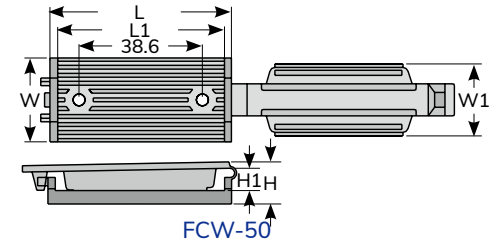

Item No.	L	L1	W	W1	H	H1	For Cable	Packing
FC-30	45.8	32.0	19.2	14.9	2.8	7.2		100pcs
FC-40	53.3	39.5	19.2	14.8	2.6	6.2		
FC-50	77.5	63.5	19.3	14.9	2.8	6.0	50PIN	
FCT-30	45.1	31.8	18.5	16.0	16.3	11.3	30PIN	
FCT-40	67.0	54.0	15.7	12.0	16.3	11.3	40PIN	
FCT-50	78.4	65.0	18.6	15.8	16.3	11.3	50PIN	
FC-635	76.2	63.5	6.4				50PIN	
FC-776	90.0	77.6	6.4				60PIN	
FCP-315	44.7	31.4	19.1	15.2	12.4	7.6	30PIN	
FCW-50	56.8	52.2	26.2	23.0	13.0	7.0	30PIN	

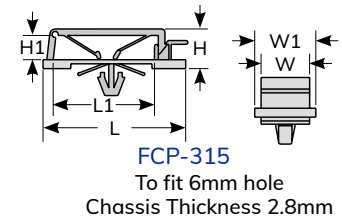
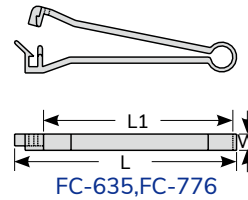
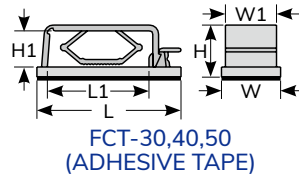
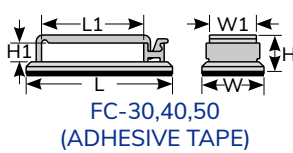

# 0538 KSS CABLE STACKER

- Material: PP with nail.
- Color: Natural.
- Feature: 1. With steel nail inserted, quick installation to reduce time and cost.  
2. Separation design to distinguish power cable and signal cables.

UNIT : mm

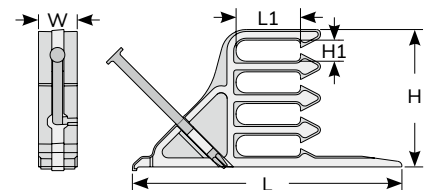

Item No.	Dimension					Nails	Packing
	L	L1	W	H	H1		
CST-1	83.4	19.9	12.0	42.0	6.5	2.9X52	25pcs

## 0539 KSS CABLE CLAMP

- Material: UL94V-2 flame rated, UL approved Nylon 66 with adhesive tape.
- Color: Black.
- Application: Peel off the liner and position on the flat surface, open the lid to fix wires or cables.
- Feature:
  1. Design for easy installation and reusable.
  2. Separation design to distinguish power cable and signal cables.



UNIT : mm

Item No.	Dimension		Packing
	L	W	
SWD-6	87	14.2	100pcs

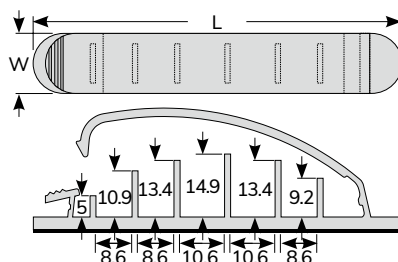

Wiring Ducts

Cable Markers

Cable Ties

Wrapping Bands

Cable Clamps &amp; Tie Mounts

## 0540 KSS CABLE CLAMP

- Material: Steel with PVC tube.
- Application: Screw to fix on the flat surface, and bend to fix cable easily.
- Feature: PVC Tube to avoid damage on the cables, reusable, and easy for maintenance.



UNIT : mm

Item No.	Dimension			Packing
	L1	W	M	
CW3-32	32.1	7.5	3.3	100pcs
CW3-52	52.1	7.5	3.3	
CW3-60	62.1	8.0	3.6	
CW4-35	35.2	8.5	4.2	
CW4-50	52.2	8.0	4.2	
CW4-75	74.5	7.5	4.2	
CW4-78	78.5	8.0	4.2	
CW5-70	69.3	8.5	5.1	
CW6-78	78.0	10.0	6.0	
CW10-95	95.0	16.0	10.0	
CW10-115	115.0	16.0	10.0	

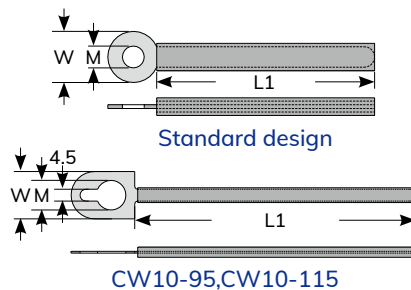

Glands, Bushings

Conduits

Bushings

Wire Connectors

Tubes

## 0545 KSS SELF-ADHESIVE WIRE CLIP

- Material: Steel with adhesive tape.
- Application: Peel off the liner and position on the flat surface. The metal part can be bent, to fix cable easily.



UNIT : mm

Item No.	Dimension					Packing
	L1	L2	W	W1	H	
MWC-15	10.0	15.0	19.4	5.0	0.5	100pcs
MWC-25	15.0	25.0	25.0	5.0	0.5	

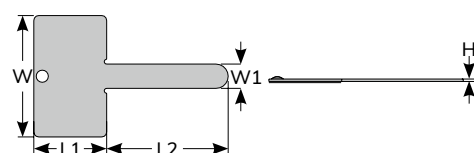

Cable Clips

PCB Parts

Fasteners

## 0550 KSS PAPER ROLL CLIP



- Material: ABS.
- Color: Natural.
- Application: Tight up paper and clip on the paper roll.

UNIT : mm

Item No.	Bundle Dia.	H	Packing
PRP-35	37	10.1	100pcs

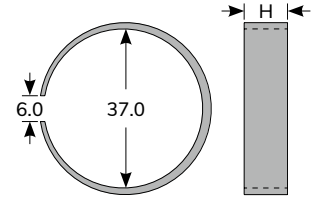

## 0555 KSS SNAP CLAMP



- Material: UL94V-2 flame rated, UL approved Nylon 66.
- Color: Natural.
- Feature: 1. one size of adjustable snap clamp can accommodate various cables.  
2. easy to install and fast to fix.

UNIT : mm

Item No.	T	Bundle Dia. D	Packing
SHW-13	1.8	11.9 ~ 13.5	100pcs
SHW-15		13.5 ~ 15.1	

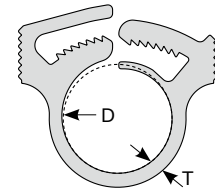

## 0558 KSS PIPE CLIP



- Material: PE.
- Screw the pipe clip to the wall, and push the pipe or cable into clip to fasten.
- Can be unlimited extended ( even between different sizes) with special inter-lock design on the sides.

UNIT : mm

Item No.	L	W	H	Mounting Hole M	Bundle Dia. D	Packing
PPC-16	21.8	14.4	24.4	4.3 x 7.9	16	50pcs
<b>NEW</b> PPC-18	24.2	14.4	26.0	4.3 x 10.6	18	
PPC-20	26.6	14.4	28.9	4.3 x 8.6	20	
<b>NEW</b> PPC-22	28.3	14.4	30.2	4.3 x 10.6	22	
PPC-25	33.5	14.4	32.8	4.3 x 10.8	25	
<b>NEW</b> PPC-26	34.0	14.4	33.8	4.3 x 11.8	26	
<b>NEW</b> PPC-32	42.5	14.4	38.8	4.3 x 16.8	32	
<b>NEW</b> PPC-40	52.5	14.4	46.1	4.3 x 22.0	40	

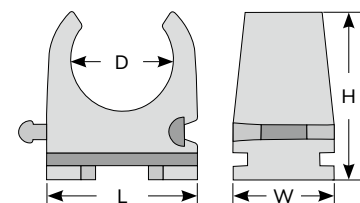



# Glands, Bushings

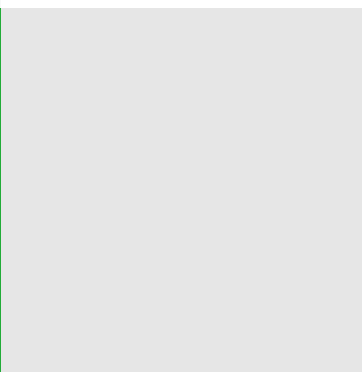
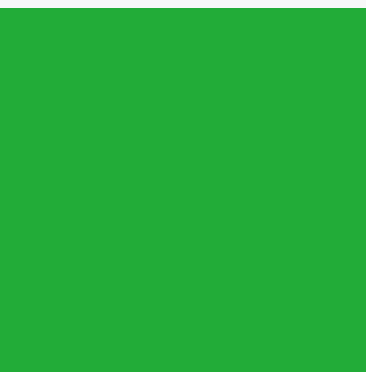
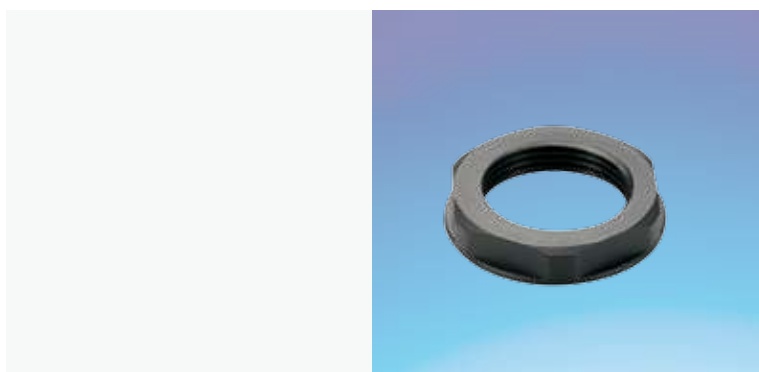
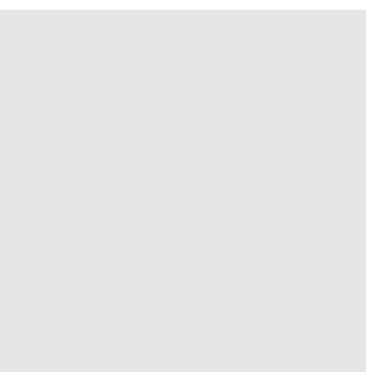

Wiring Ducts

Cable Markers

Cable Ties

Wrapping Bands

Cable Clamps & Tie Mounts

**Glands, Bushings**

Conducts

Bushings

Wire Connectors

Tubes

Cable Clips

PCB Parts

Fasteners

## Thread Standard Reference Table

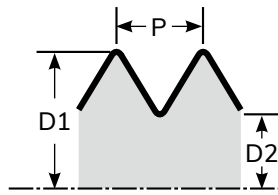

Metric	Pitch P	Outside Diameter D1	Minor Diameter D2	Recommended Drill Size	Panel Mounting Hole
	mm	∅ mm	∅ mm	∅ mm	∅ mm
M12	1.5	12	10.376	10.6	12 ~ 12.3
M16	1.5	16	14.376	14.6	16 ~ 16.3
M20	1.5	20	18.376	18.6	20 ~ 20.3
M25	1.5	25	23.376	23.6	25 ~ 25.4
M32	1.5	32	30.376	30.6	32 ~ 32.4
M40	1.5	40	38.376	38.6	40 ~ 40.4
M50	1.5	50	48.376	48.6	50 ~ 50.4
M63	1.5	63	61.376	61.6	63 ~ 63.4

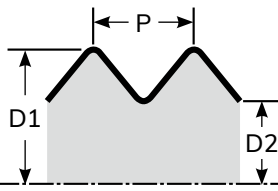

PG	Pitch P	Outside Diameter D1	Minor Diameter D2	Recommended Drill Size	Panel Mounting Hole
	mm	∅ mm	∅ mm	∅ mm	∅ mm
PG 7	1.27	12.5	11.28	11.4	12.5 ~ 12.8
PG 9	1.41	15.2	13.86	14	15.2 ~ 15.5
PG 11	1.41	18.6	17.26	17.4	18.6 ~ 18.9
PG 13.5	1.41	20.4	19.06	19.2	20.4 ~ 20.7
PG 16	1.41	22.5	21.16	21.3	22.5 ~ 22.8
PG 21	1.588	28.3	26.78	27	28.3 ~ 28.7
PG 29	1.588	37	35.48	35.7	37 ~ 37.4
PG 36	1.588	47	45.48	45.7	47 ~ 47.4
PG 42	1.588	54	52.48	52.7	54 ~ 54.4
PG 48	1.588	59.3	57.78	58	59.3 ~ 59.7

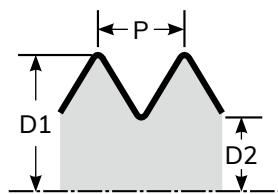

G ( PF )	Pitch P	Outside Diameter D1	Minor Diameter D2	Recommended Drill Size	Panel Mounting Hole
	mm	∅ mm	∅ mm	∅ mm	∅ mm
PF 1/4	1.337	13.157	11.445	11.8	13.2 ~ 13.4
PF 3/8	1.337	16.662	14.95	15.3	16.7 ~ 16.9
PF 1/2	1.814	20.955	18.631	19	21 ~ 21.2
PF 3/4	1.814	26.441	24.117	24.5	26.5 ~ 26.8
PF 5/8	1.814	22.91	20.587	23~23.3	23~23.3
PF 1	2.309	33.249	30.291	30.8	33.3 ~ 33.6
PF 1 1/2	2.309	47.803	44.845	45.3	48 ~ 48.4
PF 2	2.309	59.614	56.656	57	60 ~ 60.4

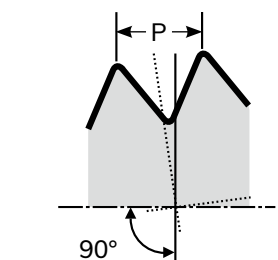

NPT	Pitch P	Outside Diameter	Recommended Drill Size	Panel Mounting Hole
	mm	∅ mm	∅ mm	∅ mm
NPT 1/4	1.411	13.616	11.1	13.9 ~ 14.1
NPT 3/8	1.411	17.055	14.5	17.2 ~ 17.4
NPT 1/2	1.814	21.223	17.8	21.4 ~ 21.7
NPT 3/4	1.814	26.568	23	26.8 ~ 27.1
NPT 1	2.208	33.227	29	33.5 ~ 33.8
NPT 1 1/4	2.208	41.984	38	42.3 ~ 42.7

# Technical Data

## KSS Conduit, Cable Gland, Install Tools Reference Table

Flexible Conduit	Suitable Adaptor
Close design	
CRS-05P	
CRS-07P	PAQ-0707, PAQ-0709
CRS-11SP	
CRS-11P	PAQ-1216, PAQ-1211, PAQ-1209, PAQ-12135, BG-16, BGQ-16
CRS-13P	BG-16, BGQ-18
CRS-15P	BGQ-20
CRS-17P	PAQ-17135, PAQ-1721, BG-22, BGQ-22
CRS-19P	BG-26, BGQ-25
CRS-22P	BG-26, BGQ-26
CRS-24P	BG-32, BGQ-32
CRS-25P	BG-32
CRS-28P	BG-34, BGQ-34
CRS-32P	BG-40
CRS-35P	
CRS-40P	BG-48, BG-50
CRS-48P	PAQ-4848
PA-07	PAQ-0707, PAQ-0709
PA-10	PAQ-1009
PA-12	PAQ-1209, PAQ-1211, PAQ-12135, PAQ-1216
PA-17	PAQ-17135, PAQ-1716, PAQ-1721
PA-23	PAQ-2321
PA-29	PAQ-2929
PA-36	PAQ-3636
PA-48	PAQ-4848
CF-14P	BG-14
CF-18P	BG-18
CF-22P	BG-22
CF-26P	BG-26
CF-34P	BG-34
CF-42P	
CP-26POE	
CP-34POE	
CP-40POE	
CP-51POE	
BG-10P	BG-10
BG-14P	BG-14
BG-16P	BG-16, BGQ-16
BG-18P	BG-18, BGQ-18
BG-20P	BG-20, BGQ-20
BG-22P	BG-22, BGQ-22
BG-25P	BG-25, BGQ-25
BG-26P	BG-26, BGQ-26
BG-32P	BG-32, BGQ-32
BG-34P	BG-34, BGQ-34
BG-40P	BG-40
BG-42P	BG-42
BG-48P	BG-48
BG-50P	BG-50
BG-55P	
BG-60P	
BG-76P	

Flexible Conduit	KSS Split Wrapping Band installation tool (see P. 100)
Split design	
CR-05P	
CR-07P	KT-8BK
CR-11SP	KT-8BK
CR-11P	KT-8BK
CR-13P	KT-15BK
CR-15P	KT-15BK
CR-17P	KT-20BK
CR-19P	KT-20BK
CR-22P	KT-20BK
CR-24P	KT-25BK
CR-25P	KT-25BK
CR-28P	KT-32BK
CR-32P	KT-32BK
CR-35P	
CR-40P	
CR-48P	
PAO-07	KT-8BK
PAO-10	KT-8BK
PAO-12	KT-15BK
PAO-17	KT-15BK
PAO-23	KT-20BK
PAO-29	KT-25BK
PAO-36	KT-32BK
PAO-48	

- Wiring Ducts
- Cable Markers
- Cable Ties
- Wrapping Bands
- Cable Clamps & Tie Mounts
- Glands, Bushings**
- Conduits
- Bushings
- Wire Connectors
- Tubes
- Cable Clips
- PCB Parts
- Fasteners

# 0604 KSS NYLON CABLE GLAND

- Material : UL94V-2 flame rated, UL approved Nylon 66, TPE for Seal, PVC for Washer.
- Color: Black, available in other colors.
- Suit a variety of applications, and diverse industries.
- Function : Mount gland to pre-drilled panel hole, use locknut to fix gland on board, insert the cables in the seal, and then tighten up the nut to hold cables in position.
- Feature : Simply and quickly fixed, high degree of the protection IP68 preventing dust and water.
- Part number AG-D series, smaller size, suit for smaller cabinet.
- Available to order the accessories separately. Follow the drawing and add the letter to the suffix part number, L for locknut, W for washer, B for gland body, S for seal, N for nut. For example, AGL-12 if you would like to only order locknut for M12x1.25

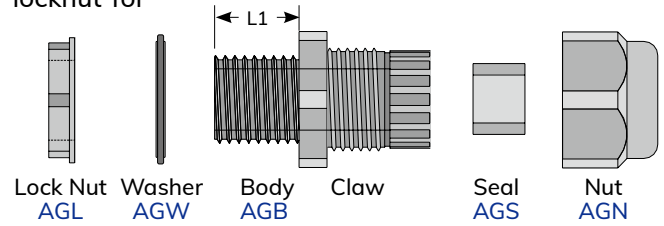

## METRIC THREAD ※Protection : IP68

UNIT : mm

Item No.	Thread	Thread O.D.	Mounting Hole	L1	Cable Range	Packing	
AG-12	M12x1.25	12	12+0.2	7.9	3~6.5	50pcs	
AG-12L	M12x1.5	12	12+0.2	7.9	3~6.5		
AG-12H	M12x1.25	12	12+0.2	7.9	3~7.5		
<b>NEW</b> AG-12HL	M12x1.25	12	12+0.2	9.0	3~7.5		
AG-16	M16x1.5	16	16+0.2	15.5	5~10		
AG-16S	M16x1.5	16	16+0.2	10.0	5~10		
AG-20	M20x1.5	20	20+0.2	15.0	10~14		
AG-20S	M20x1.5	20	20+0.2	10.0	10~14		
AG-25	M25x1.5	25	25+0.3	15.2	13~18		
AG-25S	M25x1.5	25	25+0.3	10.0	13~18		
AG-32	M32x1.5	32	32+0.3	14.7	18~25		25pcs
AG-40	M40x1.5	40	40+0.3	18.4	22~32		10pcs
AG-50	M50x1.5	50	50+0.3	17.8	30~38		
AG-63	M61x1.5	61	61+0.3	18.5	34~44		
AG-63M	M63x1.5	63	63+0.3	18.5	34~44		
<b>NEW</b> AG-75	M75x2.0	75	75+0.4	25.1	56~66		2pcs

Part number AG-D series, smaller size, suit for smaller cabinet.

AG-12D	M12x1.5	12	12+0.2	8.0	3~6	50pcs
AG-16D	M16x1.5	16	16+0.2	8.2	5~10	
AG-20D	M20x1.5	20	20+0.2	10.0	8~12	
AG-25D	M25x1.5	25	25+0.3	10.0	11~17	
AG-32D	M32x1.5	32	32+0.3	10.0	15~21	25pcs
AG-40D	M40x1.5	40	40+0.3	10.0	20~28	10pcs
AG-50D	M50x1.5	50	50+0.3	12.0	27~35	
AG-63D	M63x1.5	63	63+0.3	16.7	32~42	

# 0604 KSS NYLON CABLE GLAND

- Material : UL94V-2 flame rated, UL approved Nylon 66, TPE for Seal, PVC for Washer.
- Color: Black, available in other colors.
- Suit a variety of applications, and diverse industries.
- Function : Mount gland to pre-drilled panel hole, use locknut to fix gland on board, insert the cables in the seal, and then tighten up the nut to hold cables in position.
- Feature : Simply and quickly fixed, **Body and Claw are separate.**
- Available to order the accessories separately. Follow the drawing and add the letter to the suffix part number, L for locknut, W for washer, B for gland body, S for seal, C for claw, N for nut. For example, CAGL-12 if you would like to only order locknut for M12x1.25

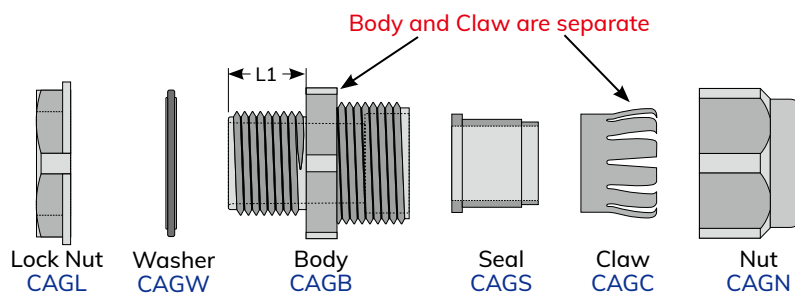

## METRIC THREAD ※Protection : IP68

UNIT : mm

Item No.	Thread	Thread O.D.	Mounting Hole	L1	Cable Range	Packing
CAG-12	M12x1.25	12	12.0+0.2	8.1	3~6.5	50pcs
CAG-16	M16x1.5	16	16.0+0.2	15.5	5~10	
CAG-20	M20x1.5	20	20.0+0.2	15.0	10~14	
CAG-25	M25x1.5	25	25.0+0.3	15.3	13~18	25pcs
CAG-32	M32x1.5	32	32.0+0.3	15.0	18~25	
CAG-40	M40x1.5	40	40.0+0.3	18.2	22~32	
CAG-50	M50x1.5	50	50.0+0.3	18.2	30~38	
CAG-63	M63x1.5	63	63.0+0.3	18.2	34~44	10pcs

# 0606 KSS NYLON CABLE GLAND

- Material: UL94V-2 flame rated, UL approved Nylon 66, TPE for Seal, PVC for Washer.
  - Color: Black, available in other colors.
  - Suit a variety of applications, and diverse industries.
  - Function :Mount gland to pre-drilled panel hole, use locknut to fix gland on board, insert the cables in the seal, and then tighten up the nut to hold cables in position.
  - Feature : Simply and quickly fixed, high degree of the protection IP68 preventing dust and water.
  - Available to order the accessories separately. Follow the drawing and add the letter to the suffix part number, L for locknut, W for washer, B for gland body, S for seal, N for nut. For example, EGL-7 if you would like to only order locknut for PG7.
- ※ EG-7LS has smaller nut.

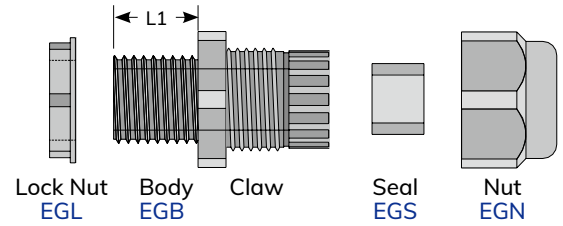

## PG THREAD (DIN STANDARD) ※Protection : IP68 ( only if the washer is assembled )

UNIT : mm

Item No.	Thread	Thread O.D.	Mounting Hole	L1	Cable Range	Packing
EG-7	PG7	12.5	12.5+0.2	7.9	3~6.5	WITHOUT WASHER 50pcs
EG-7LS	PG7	12.5	12.5+0.2	7.9	3~6.5	
EG-9	PG9	15.2	15.2+0.2	8.2	4~8	
EG-9L	PG9	15.2	15.2+0.2	14.7	4~8	
EG-11	PG11	18.6	18.6+0.2	7.9	5~10	
EG-11L	PG11	18.6	18.6+0.2	14.9	5~10	
EG-13.5	PG13.5	20.4	20.4+0.2	8.9	6~12	
EG-13.5L	PG13.5	20.4	20.4+0.2	15.8	6~12	
EG-16	PG16	22.5	22.5+0.2	9.8	10~14	
EG-21	PG21	28.3	28.3+0.3	10.8	13~18	
EG-29	PG29	37.0	37.0+0.3	10.8	18~25	25pcs
EG-36	PG36	47.0	47.0+0.3	15.0	22~32	10pcs
EG-42	PG42	54.0	54.0+0.3	14.5	30~38	
EG-48	PG48	59.3	59.3+0.3	16.7	34~44	

# 0606 KSS NYLON CABLE GLAND



- Material: UL94V-2 flame rated, UL approved Nylon 66, TPE for Seal, PVC for Washer.
- Color: Black, available in other colors.
- Suit a variety of applications, and diverse industries.
- Function :Mount gland to pre-drilled panel hole, use locknut to fix gland on board, insert the cables in the seal, and then tighten up the nut to hold cables in position.
- Feature : Simply and quickly fixed, **Body and Claw are separate.**
- Available to order the accessories separately. Follow the drawing and add the letter to the suffix part number, L for locknut, W for washer, B for gland body, S for seal, C for claw, N for nut. For example, CEG-7 if you would like to only order locknut for PG7.

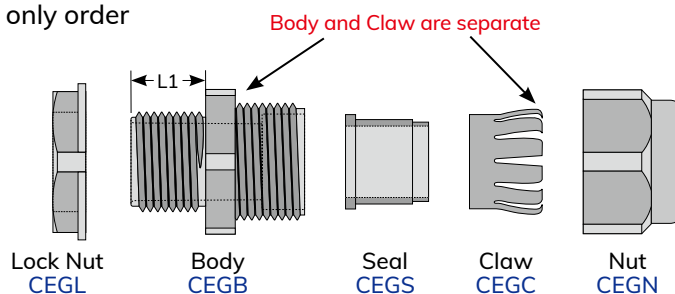

## PG THREAD (DIN STANDARD) ※Protection : IP68 ( only if the washer is assembled )

UNIT : mm

Item No.	Thread	Thread O.D.	Mounting Hole	L1	Cable Range	Packing
CEG-7	PG7	12.5	12.5+0.2	8.0	3~6.5	WITHOUT WASHER 50pcs 25pcs 10pcs
CEG-9	PG9	15.2	15.2+0.2	8.2	4~8	
CEG-11	PG11	18.6	18.6+0.2	8.2	5~10	
CEG-13.5	PG13.5	20.4	20.4+0.2	9.0	6~12	
CEG-16	PG16	22.5	22.5+0.2	9.9	10~14	
CEG-21	PG21	28.3	28.3+0.3	10.8	13~18	
CEG-29	PG29	37.0	37.0+0.3	10.8	18~25	
CEG-36	PG36	47.0	47.0+0.3	14.7	22~32	
CEG-42	PG42	54.0	54.0+0.3	14.7	30~38	
CEG-48	PG48	59.3	59.3+0.3	16.7	34~44	

# 0604 KSS NYLON CABLE GLAND

- Material: UL94V-2 flame rated, UL approved Nylon 66, TPE for Seal, PVC for Washer.
- Color: Black, available in other colors.
- Function : Mount gland to pre-drilled panel hole, use locknut to fix gland on board, insert the cables in the seal, and then tighten up the nut to hold cables in position.
- Feature : Simply and quickly fixed, high degree of the protection IP68 preventing dust and water.
- Available to order the accessories separately.



Follow the drawing and add the letter to the suffix part number, L for locknut, W for washer, B for gland body, S for seal, N for nut. For example, AGJL-14 if you would like to only order locknut for PF 1/4".

※ The degree of protection is IP68 for AGJ-17 and AGJ-34.

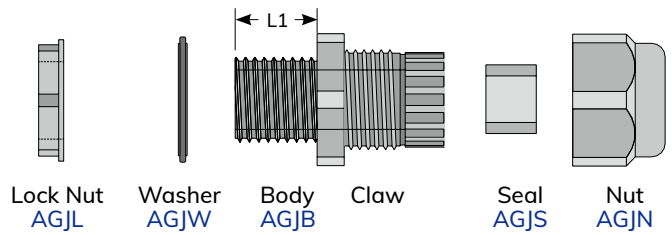

## PF THREAD ※Protection : IP68

UNIT : mm

Item No.	Thread	Thread O.D.	Mounting Hole	L1	Cable Range	Packing
	AGJ-14	PF 1/4"	13.2	13.2+0.2	8.0	3~6.5
	AGJ-17	PF 3/8"	16.7	16.7+0.2	14.7	5~10
	AGJ-21	PF 1/2"	21.0	21.0+0.2	12.9	10~14
	AGJ-58	PF 5/8"	22.9	22.9+0.2	12.9	10~14
	AGJ-27	PF 3/4"	26.4	26.4+0.3	14.7	13~18
	AGJ-34	PF 1"	33.2	33.2+0.3	14.7	18~25
	AGJ-112	PF 1 1/2"	47.8	47.8+0.3	17.8	30~38
	AGJ-2	PF 2"	59.6	59.6+0.3	18.5	34~44
	AG-16F	PF 1/2"	20.8	20.8+0.2	9.5	5~10
	AG-20F	PF Thread 14	20.8	20.8+0.2	9.3	6~13

Glands, Bushings

Conduits

Bushings

Wire Connectors

Tubes

Cable Clips

PCB Parts

Fasteners



# 0608 KSS NYLON CABLE GLAND



- Material: UL94V-2 flame rated, UL approved Nylon 66, TPE for Seal, PVC for Washer.
- Color: Black, available in other colors.

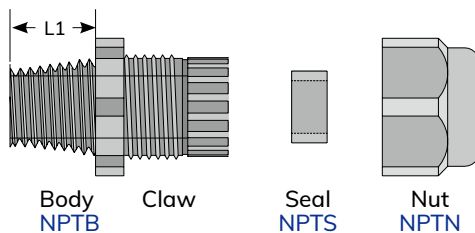

## NPT THREAD ※Protection : IP68 ( only if the washer is assembled )

UNIT : mm

Item No.	NPT Thread	Thread O.D.	Mounting Hole	L1	Cable Range	Packing
NPT-14	1/4"-18 NPT	13.3	13.3+0.2	7.8	3~6.5	50pcs
NPT-38	3/8"-18 NPT	17.2	17.2+0.2	14.6	5~10	
NPT-12	1/2"-14 NPT	21.2	21.2+0.2	12.9	10~14	
NPT-34	3/4"-14 NPT	26.3	26.3+0.3	14.5	13~18	
NPT-1	1"-11.5 NPT	33.2	33.2+0.3	14.9	18~25	25pcs
NPT-114	1 1/4"-11.5 NPT	41.9	41.9+0.3	18.2	22~32	10pcs

※ Lock nut and washer are available to be assembled upon request.

# 0609 KSS RIGHT ANGLE NYLON CABLE GLAND



- Material: UL94V-2 flame rated, UL approved Nylon 66, TPE for Seal, PVC for Washer.
- Color: Black, available in other colors.
- 90° design to protect cable from breakage.

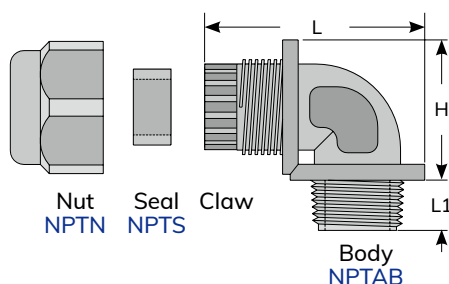

## NPT THREAD ※Protection : IP68 ( only if the washer is assembled )

UNIT : mm

Item No.	NPT Thread	Thread O.D.	Mounting Hole	L1	L	H	Cable Range	Packing
NPTA-38	3/8"-18 NPT	17.2	16.7+0.2	11.7	48.5	30.0	5~9	20pcs
NPTA-12	1/2"-14 NPT	21.2	21.2+0.2	14.7	51.6	31.2	10~13	
NPTA-34	3/4"-14 NPT	26.3	26.3+0.3	14.8	64.5	41.6	13~16	
NPTA-114	1 1/4"-11.5 NPT	41.9	41.9+0.3	18.8	85.0	53.0	22~29	10pcs

※ Lock nut and washer are available to be assembled upon request.

# 0607 KSS GLAND ADAPTOR

- Material: UL94V-2 flame rated, UL approved Nylon 66.
- Color: Grey, available in other colors.
- To allow switching from PG external thread to metric internal thread.

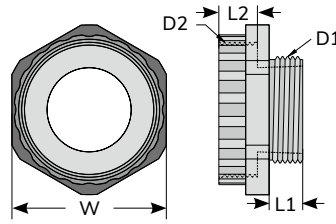

※RAL7035 Grey (GY4)

UNIT : mm

Item No.	D1				D2		W	Packing
	Thread	Thread O.D.	Mounting Hole	L1	Thread	L2		
P712GY4	PG7	12.5	12.5+0.2	8	M12X1.5	10	15.0	100pcs
P716GY4	PG7	12.5	12.5+0.2	8	M16X1.5	10	20.0	
P912GY4	PG9	15.2	15.2+0.2	8	M12X1.5	9	18.8	
P916GY4	PG9	15.2	15.2+0.2	8	M16X1.5	10	20.0	
P920GY4	PG9	15.2	15.2+0.2	8	M20X1.5	10	24.0	
P1116GY4	PG11	18.6	18.6+0.2	8	M16X1.5	9	22.0	
P1120GY4	PG11	18.6	18.6+0.2	8	M20X1.5	10	24.0	
P1316GY4	PG13.5	20.4	20.4+0.2	9	M16X1.5	9	24.0	
P1320GY4	PG13.5	20.4	20.4+0.2	9	M20X1.5	10	24.0	
P1325GY4	PG13.5	20.4	20.4+0.2	9	M25X1.5	10	30.0	
P1620GY4	PG16	22.5	22.5+0.2	10	M20X1.5	10	26.8	
P1625GY4	PG16	22.5	22.5+0.2	10	M25X1.5	10	30.0	
P2125GY4	PG21	28.3	28.3+0.3	11	M25X1.5	10	32.5	
P2132GY4	PG21	28.3	28.3+0.3	11	M32X1.5	12	36.8	
P2932GY4	PG29	37.0	37.0+0.3	11	M32X1.5	10	41.6	
P2940GY4	PG29	37.0	37.0+0.3	11	M40X1.5	11	44.8	
P3640GY4	PG36	47.0	47.0+0.3	11	M40X1.5	10	55.0	
P4250GY4	PG42	54.0	54.0+0.3	11	M50X1.5	14	55.0	
P4863GY4	PG48	59.3	59.3+0.3	11	M63X1.5	14	68.0	

# 0607 KSS ENLARGER GLAND

- Material: UL94V-2 flame rated, UL approved Nylon 66.
- Color: Grey, available in other colors.
- KSS ENLARGER GLANDS with small metric external thread and large metric internal thread to allow switching from small metric external thread to large metric using.

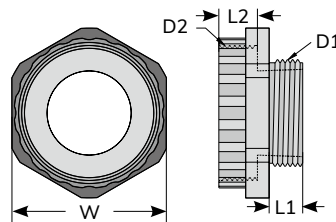

※RAL7035 Grey (GY4)

UNIT : mm

Item No.	D1				D2		W	Packing
	Thread	Thread O.D.	Mounting Hole	L1	Thread	L2		
M1216GY4	M12X1.5	12	12+0.2	8.0	M16X1.5	8.0	20.0	100PCS
M1620GY4	M16X1.5	16	16+0.2	8.0	M20X1.5	10.5	24.0	
M2025GY4	M20X1.5	20	20+0.2	8.0	M25X1.5	10.0	29.0	
M2532GY4	M25X1.5	25	25+0.3	8.0	M32X1.5	11.5	36.0	50PCS
M3240GY4	M32X1.5	32	32+0.3	10.0	M40X1.5	11.5	46.0	25PCS
M4050GY4	M40X1.5	40	40+0.3	10.0	M50X1.5	11.5	55.0	
M5063GY4	M50X1.5	50	50+0.3	10.0	M63X1.5	11.5	68.0	

# 0607 KSS REDUCTION GLAND

- Material: UL94V-2 flame rated, UL approved Nylon 66.
- Color: Black and Grey, available in other colors.
- To allow switching from large metric external thread to small metric using.

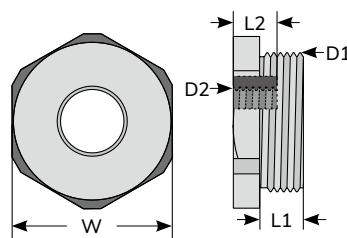

※Black

UNIT : mm

Item No.	External thread D1	Internal thread D2	L	L1	W	Packing
M2012	M20X1.5	M12X1.5	8.0	11.0	24.2	100pcs
M2016	M20X1.5	M16X1.5	8.0	12.0	24.2	
M2516	M25X1.5	M16X1.5	8.0	13.0	29.0	
M2520	M25X1.5	M20X1.5	8.0	14.0	29.0	
M3220	M32X1.5	M20X1.5	10.0	14.5	35.9	50pcs
M3225	M32X1.5	M25X1.5	10.0	15.0	35.9	
M4032	M40X1.5	M32X1.5	10.0	15.0	45.8	25pcs
M5040	M50X1.5	M40X1.5	11.5	15.0	55.0	
M6350	M63X1.5	M50X1.5	11.5	11.5	67.5	

※RAL7035 Grey (GY4)

Item No.	External thread D1	Internal thread D2	L	L1	W	Packing
M1612GY4	M16X1.5	M12X1.5	8.0	12.0	22.0	100pcs
M2512GY4	M25X1.5	M12X1.5	8.0	13.0	28.5	
M3212GY4	M32X1.5	M12X1.5	10.0	10.0	35.5	50pcs
M3216GY4	M32X1.5	M16X1.5	10.0	14.3	35.5	
M4016GY4	M40X1.5	M16X1.5	10.0	10.0	45.5	25pcs
M4020GY4	M40X1.5	M20X1.5	10.0	10.0	45.5	
M4025GY4	M40X1.5	M25X1.5	10.0	10.0	45.5	
M5020GY4	M50X1.5	M20X1.5	12.0	12.0	54.5	
M5025GY4	M50X1.5	M25X1.5	12.0	12.0	54.5	
M5032GY4	M50X1.5	M32X1.5	12.0	12.0	54.5	
M6325GY4	M63X1.5	M25X1.5	12.0	12.0	67.5	
M6332GY4	M63X1.5	M32X1.5	12.0	12.0	67.5	
M6340GY4	M63X1.5	M40X1.5	12.0	12.0	67.5	

# 0603 KSS NYLON CABLE GLAND (WITH STRAIN RELIEF)

Strain relief design protect cable from breakage/right angle bending

- Material: UL94V-2 flame rated, UL approved Nylon 66, TPE for Seal, PVC for Washer.
- Color: Black, available in other colors.
- EG-SR series without washer, NPT-SR without washer and lock nut.

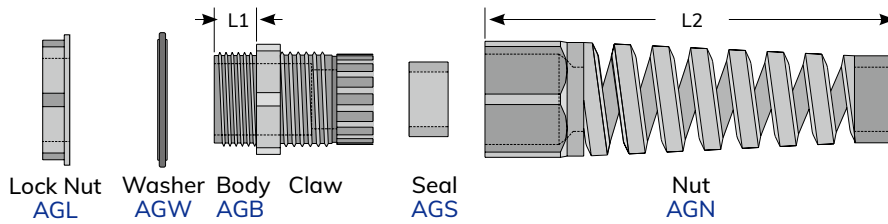

METRIC THREAD ※Protection : IP68

UNIT : mm

Item No.	Thread	Thread O.D.	Mounting Hole	L1	L2	Cable Range	Packing
AG-12SR	M12x1.25	12	12+0.2	7.9	53.3	3~6.5	50pcs
AG-16SR	M16x1.5	16	16+0.2	15.5	74.4	5~10	
AG-20SR	M20x1.5	20	20+0.2	15.0	96.2	10~14	
AG-25SR	M25x1.5	25	25+0.3	15.2	111.2	13~18	25pcs

PG THREAD ※ Without washer

EG-7SR	PG-7	12.5	12.5+0.2	7.9	53.3	3~6.5	50pcs
EG-9SR	PG-9	15.2	15.2+0.2	7.9	61.0	4~8	
EG-11SR	PG-11	18.6	18.6+0.2	7.9	74.9	5~10	
EG-13.5SR	PG-13.5	20.4	20.4+0.2	8.9	85.5	6~12	
EG-16SR	PG-16	22.5	22.5+0.2	9.8	96.2	10~14	
EG-21SR	PG-21	28.3	28.3+0.3	10.8	111.2	13~18	25pcs

PF THREAD (G)

AGJ-14SR	PF1/4"	13.2	13.2+0.2	8.0	53.3	3~6.5	50pcs
AGJ-17SR	PF3/8"	16.7	16.7+0.2	14.7	74.9	5~10	
AGJ-21SR	PF1/2"	21.0	21.0+0.2	12.9	96.2	10~14	
AGJ-27SR	PF3/4"	26.4	26.4+0.3	14.7	111.2	13~18	25pcs

NPT THREAD ※ Without washer and lock nut.

NPT-14SR	1/4"-18 NPT	13.3	13.3+0.2	7.8	53.3	3~6.5	50pcs
NPT-38SR	3/8"-18 NPT	17.2	17.2+0.2	14.6	74.9	5~10	
NPT-12SR	1/2"-14 NPT	21.2	21.2+0.2	12.9	96.2	10~14	
NPT-34SR	3/4"-14 NPT	26.3	26.3+0.3	14.5	111.2	13~18	25pcs

# 0605 KSS BUSHING GLAND



OPTION

- Material: PVC
- Color: Black
- Interior diameter of each gland available in three sizes D.E.F. Cut unnecessary part(s) optionally to fit your different cable diameters.
- To be applied for fixation and protection of cables.

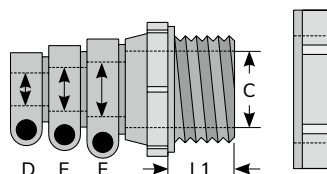

UNIT : mm

Item No.	Thread O.D.	Mounting Hole	L1	C	D	E	F	Packing
KB-1	20	20+0.2	13.0	14.0	6.0	8.0	10.0	50pcs
KB-2	22	22+0.2	17.5	16.6	10.0	13.0	15.0	

# 0610 KSS MICRO SWITCH COVER



OPTION

- Material: Flexible PVC
- Color: Black
- Designed to protect micro switch applied on machinery. Also prevent cables from breakage.
- Available in 45° and 90° type.



UNIT : mm

Item No.	Angle Type	ØA	ØB	ØC	W	H	L	Packing
CB-1	90°	7	9		49	27	19	50pcs
CB-2	45°	7	9	11	49	27	19	

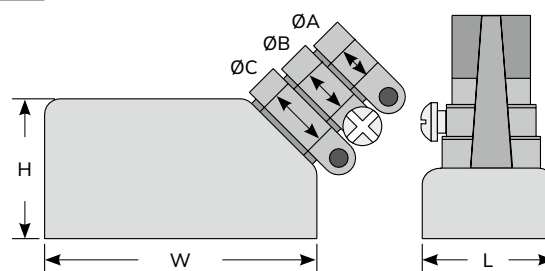

Wiring Ducts

Cable Markers

Cable Ties

Wrapping Bands

Cable Clamps & Tie Mounts

Glands, Bushings

Conduits

Bushings

Wire Connectors

Tubes

Cable Clips

PCB Parts

Fasteners

# 0613 KSS MULTI-HOLE NYLON CABLE GLAND ( 2 HOLES )

- Material: UL94V-2 flame rated, UL approved Nylon 66, TPE for Seal, PVC for Washer.
- Color: Black, available in other colors.
- Multi-Hole Design organizes more than one cable within a gland.



## METRIC THREAD

Item No.	M Thread	Mounting Hole	L1	Cable Range	Packing
AG-12-2A	M12X1.25	12~12.3	7.9	2.0~3.1	50pcs
AG-12L-2A	M12X1.5	12~12.3	7.9	2.0~3.1	
AG-16-2A	M16X1.5	16~16.3	15.5	1.6~2.6	
AG-16-2B	M16X1.5	16~16.3	15.5	2.0~3.1	
AG-16-2C	M16X1.5	16~16.3	15.5	3.0~4.1	
AG-16S-2A	M16X1.5	16~16.3	10.0	1.6~2.6	
AG-16S-2B	M16X1.5	16~16.3	10.0	2.0~3.1	
AG-16S-2C	M16X1.5	16~16.3	10.0	3.0~4.1	
AG-20-2A	M20X1.5	20~20.3	15.0	1.6~2.6	
AG-20-2B	M20X1.5	20~20.3	15.0	2.0~3.0	
AG-20-2C	M20X1.5	20~20.3	15.0	2.5~3.5	
AG-20-2D	M20X1.5	20~20.3	15.0	3.0~4.1	
AG-20-2E	M20X1.5	20~20.3	15.0	3.3~4.3	
AG-20-2F	M20X1.5	20~20.3	15.0	3.5~5.2	
AG-20-2G	M20X1.5	20~20.3	15.0	4.3~6.1	
AG-20S-2A	M20X1.5	20~20.3	10.0	1.6~2.6	
AG-20S-2B	M20X1.5	20~20.3	10.0	2.0~3.0	
AG-20S-2C	M20X1.5	20~20.3	10.0	2.5~3.5	
AG-20S-2D	M20X1.5	20~20.3	10.0	3.0~4.1	
AG-20S-2E	M20X1.5	20~20.3	10.0	3.3~4.3	
AG-20S-2F	M20X1.5	20~20.3	10.0	3.5~5.2	
AG-20S-2G	M20X1.5	20~20.3	10.0	4.3~6.1	
AG-25-2A	M25X1.5	25~25.4	15.2	2.5~3.5	25pcs
AG-25-2B	M25X1.5	25~25.4	15.2	3.3~4.3	
AG-25-2C	M25X1.5	25~25.4	15.2	3.5~5.1	
AG-25-2D	M25X1.5	25~25.4	15.2	4.3~6.1	
AG-25-2E	M25X1.5	25~25.4	15.2	5.1~6.5	
AG-25-2F	M25X1.5	25~25.4	15.2	6.4~8.7	
AG-25S-2A	M25X1.5	25~25.4	10.0	2.5~3.5	
AG-25S-2B	M25X1.5	25~25.4	10.0	3.3~4.3	
AG-25S-2C	M25X1.5	25~25.4	10.0	3.5~5.1	
AG-25S-2D	M25X1.5	25~25.4	10.0	4.3~6.1	
AG-25S-2E	M25X1.5	25~25.4	10.0	5.1~6.5	
AG-25S-2F	M25X1.5	25~25.4	10.0	6.4~8.7	
AG-32-2A	M32X1.5	32~32.4	14.7	3.6~5.2	25pcs
AG-32-2B	M32X1.5	32~32.4	14.7	5.1~6.5	
AG-32-2C	M32X1.5	32~32.4	14.7	6.4~8.7	
AG-32-2D	M32X1.5	32~32.4	14.7	7.7~10	
AG-40-2A	M40X1.5	40~40.4	18.4	7.0~9.0	10pcs
AG-40-2B	M40X1.5	40~40.4	18.4	11~13	

## PG THREAD ※ Without washer

UNIT : mm

Item No.	PG Thread	Mounting Hole	L1	Cable Range	Packing
EG-7-2A	PG7	12.5~12.8	7.9	2.0~3.1	50pcs
EG-7LS-2A	PG7	12.5~12.8	7.9	2.0~3.1	
EG-9-2A	PG9	15.2~15.5	8.2	2.0~3.1	
EG-9L-2A	PG9	15.2~15.5	14.7	2.0~3.1	
EG-11-2A	PG11	18.6~18.9	7.9	1.6~2.6	
EG-11-2B	PG11	18.6~18.9	7.9	2.0~3.1	
EG-11-2C	PG11	18.6~18.9	7.9	3.0~4.1	
EG-11L-2A	PG11	18.6~18.9	14.9	1.6~2.6	
EG-11L-2B	PG11	18.6~18.9	14.9	2.0~3.1	
EG-11L-2C	PG11	18.6~18.9	14.9	3.0~4.1	
EG-13-2A	PG13.5	20.4~20.7	8.9	3.5~5.2	
EG-13L-2A	PG13.5	20.4~20.7	15.8	3.5~5.2	
EG-16-2A	PG16	22.5~22.8	9.8	1.6~2.6	
EG-16-2B	PG16	22.5~22.8	9.8	2.0~3.0	
EG-16-2C	PG16	22.5~22.8	9.8	2.5~3.5	
EG-16-2D	PG16	22.5~22.8	9.8	3.0~4.1	
EG-16-2E	PG16	22.5~22.8	9.8	3.3~4.3	
EG-16-2F	PG16	22.5~22.8	9.8	3.5~5.2	
EG-16-2G	PG16	22.5~22.8	9.8	4.3~6.1	
EG-21-2A	PG21	28.3~28.7	10.8	2.5~3.5	
EG-21-2B	PG21	28.3~28.7	10.8	3.3~4.3	
EG-21-2C	PG21	28.3~28.7	10.8	3.5~5.1	
EG-21-2D	PG21	28.3~28.7	10.8	4.3~6.1	
EG-21-2E	PG21	28.3~28.7	10.8	5.1~6.5	
EG-21-2F	PG21	28.3~28.7	10.8	6.4~8.7	
EG-29-2A	PG29	37.0~37.4	10.8	3.6~5.2	25pcs
EG-29-2B	PG29	37.0~37.4	10.8	5.1~6.5	
EG-29-2C	PG29	37.0~37.4	10.8	6.4~8.7	
EG-29-2D	PG29	37.0~37.4	10.8	7.7~10	
EG-36-2A	PG36	47.0~47.4	15.0	7~9	10pcs
EG-36-2B	PG36	47.0~47.4	15.0	11~13	

washer are available to be assembled upon request.

# 0613 KSS MULTI-HOLE NYLON CABLE GLAND ( 2 HOLES)

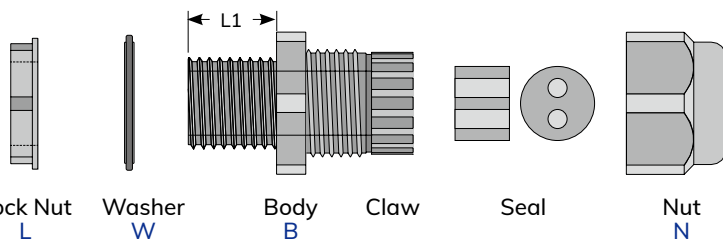

Part No.:

## PF THREAD

Item No.	PF Thread	Mounting Hole	L1	Cable Range	Packing
AGJ-14-2A	PF1/4"	14~14.3	8.0	2.0~3.1	50pcs
AGJ-17-2A	PF3/8"	17~17.3	7.9	1.6~2.6	
AGJ-17-2B	PF3/8"	17~17.3	7.9	2.0~3.1	
AGJ-17-2C	PF3/8"	17~17.3	7.9	3.0~4.1	
AGJ-21-2A	PF1/2"	21~21.3	12.9	1.6~2.6	
AGJ-21-2B	PF1/2"	21~21.3	12.9	2.0~3.0	
AGJ-21-2C	PF1/2"	21~21.3	12.9	2.5~3.5	
AGJ-21-2D	PF1/2"	21~21.3	12.9	3.0~4.1	
AGJ-21-2E	PF1/2"	21~21.3	12.9	3.3~4.3	
AGJ-21-2F	PF1/2"	21~21.3	12.9	3.5~5.2	
AGJ-21-2G	PF1/2"	21~21.3	12.9	4.3~6.1	
AGJ-27-2A	PF3/4"	27~27.3	14.7	2.5~3.5	
AGJ-27-2B	PF3/4"	27~27.3	14.7	3.3~4.3	
AGJ-27-2C	PF3/4"	27~27.3	14.7	3.5~5.1	
AGJ-27-2D	PF3/4"	27~27.3	14.7	4.3~6.1	
AGJ-27-2E	PF3/4"	27~27.3	14.7	5.1~6.5	
AGJ-27-2F	PF3/4"	27~27.3	14.7	6.4~8.7	
AGJ-34-2A	PF1"	34~34.4	14.7	3.6~5.2	25pcs
AGJ-34-2B	PF1"	34~34.4	14.7	5.1~6.5	
AGJ-34-2C	PF1"	34~34.4	14.7	6.4~8.7	
AGJ-34-2D	PF1"	34~34.4	14.7	7.7~10	

## NPT THREAD ※ Without washer and lock nut UNIT : mm

Item No.	NPT Thread	Mounting Hole	L1	Cable Range	Packing
NPT-14-2A	1/4"-18 NPT	13.2~13.5	7.8	2.0~3.1	50pcs
NPT-38-2A	3/8"-18 NPT	16.7~17.0	14.6	1.6~2.6	
NPT-38-2B	3/8"-18 NPT	16.7~17.0	14.6	2.0~3.1	
NPT-38-2C	3/8"-18 NPT	16.7~17.0	14.6	3.0~4.1	
NPT-12-2A	1/2"-14 NPT	21.2~21.5	12.9	1.6~2.6	
NPT-12-2B	1/2"-14 NPT	21.2~21.5	12.9	2.0~3.0	
NPT-12-2C	1/2"-14 NPT	21.2~21.5	12.9	2.5~3.5	
NPT-12-2D	1/2"-14 NPT	21.2~21.5	12.9	3.0~4.1	
NPT-12-2E	1/2"-14 NPT	21.2~21.5	12.9	3.3~4.3	
NPT-12-2F	1/2"-14 NPT	21.2~21.5	12.9	3.5~5.2	
NPT-12-2G	1/2"-14 NPT	21.2~21.5	12.9	4.3~6.1	
NPT-34-2A	3/4"-14 NPT	26.3~26.6	14.5	2.5~3.5	
NPT-34-2B	3/4"-14 NPT	26.3~26.6	14.5	3.3~4.3	
NPT-34-2C	3/4"-14 NPT	26.3~26.6	14.5	3.5~5.1	
NPT-34-2D	3/4"-14 NPT	26.3~26.6	14.5	4.3~6.1	
NPT-34-2E	3/4"-14 NPT	26.3~26.6	14.5	5.1~6.5	
NPT-34-2F	3/4"-14 NPT	26.3~26.6	14.5	6.4~8.7	
NPT-1-2A	1"-11.5 NPT	33.2~33.6	14.9	3.6~5.2	25pcs
NPT-1-2B	1"-11.5 NPT	33.2~33.6	14.9	5.1~6.5	
NPT-1-2C	1"-11.5 NPT	33.2~33.6	14.9	6.4~8.7	
NPT-1-2D	1"-11.5 NPT	33.2~33.6	14.9	7.7~10	
NPT-114-2A	1 1/4"-11.5 NPT	41.9~42.3	18.2	7.0~9.0	10pcs
NPT-114-2B	1 1/4"-11.5 NPT	41.9~42.3	18.2	11~13	

Lock nut and washer are available to be assembled upon request.

Wiring Ducts

Cable Markers

Cable Ties

Wrapping Bands

Cable Clamps & Tie Mounts

Glands, Bushings

Conduits

Bushings

Wire Connectors

Tubes

Cable Clips

PCB Parts

Fasteners

# 0613 KSS MULTI-HOLE NYLON CABLE GLAND ( 3 HOLES )

- Material: UL94V-2 flame rated, UL approved Nylon 66, TPE for Seal, PVC for Washer.
- Color: Black, available in other colors.
- Multi-Hole Design organizes more than one cable within a gland.



## METRIC THREAD

Item No.	M Thread	Mounting Hole	L1	Cable Range	Packing
AG-12-3A	M12X1.25	12~12.3	7.9	1.6~2.6	50pcs
AG-12L-3A	M12X1.5	12~12.3	7.9	1.6~2.6	
AG-16-3A	M16X1.5	16~16.3	15.5	1.6~2.6	
AG-16-3B	M16X1.5	16~16.3	15.5	2.0~3.0	
AG-16-3C	M16X1.5	16~16.3	15.5	3.0~4.2	
AG-16S-3A	M16X1.5	16~16.3	10.0	1.6~2.6	
AG-16S-3B	M16X1.5	16~16.3	10.0	2.0~3.0	
AG-16S-3C	M16X1.5	16~16.3	10.0	3.0~4.2	
AG-20-3A	M20X1.5	20~20.3	15.0	2.0~3.0	
AG-20-3B	M20X1.5	20~20.3	15.0	2.6~3.6	
AG-20-3C	M20X1.5	20~20.3	15.0	3.0~4.2	
AG-20-3D	M20X1.5	20~20.3	15.0	3.5~5.0	
AG-20-3E	M20X1.5	20~20.3	15.0	3.5~5.2	
AG-20S-3A	M20X1.5	20~20.3	10.0	2.0~3.0	
AG-20S-3B	M20X1.5	20~20.3	10.0	2.6~3.6	
AG-20S-3C	M20X1.5	20~20.3	10.0	3.0~4.2	
AG-20S-3D	M20X1.5	20~20.3	10.0	3.5~5.0	
AG-20S-3E	M20X1.5	20~20.3	10.0	3.5~5.2	
AG-25-3A	M25X1.5	25~25.4	15.2	2.6~3.6	
AG-25-3B	M25X1.5	25~25.4	15.2	3.6~5.2	
AG-25-3C	M25X1.5	25~25.4	15.2	4.8~6.2	
AG-25-3D	M25X1.5	25~25.4	15.2	6.2~8.0	
AG-25S-3A	M25X1.5	25~25.4	10.0	2.6~3.6	
AG-25S-3B	M25X1.5	25~25.4	10.0	3.6~5.2	
AG-25S-3C	M25X1.5	25~25.4	10.0	4.8~6.2	
AG-25S-3D	M25X1.5	25~25.4	10.0	6.2~8.0	
AG-32-3A	M32X1.5	32~32.4	14.7	3.6~5.2	
AG-32-3B	M32X1.5	32~32.4	14.7	4.8~6.2	
AG-32-3C	M32X1.5	32~32.4	14.7	6.2~8.0	
AG-32-3D	M32X1.5	32~32.4	14.7	7.7~10	
AG-40-3A	M40X1.5	40~40.4	18.4	6.5~8.3	
AG-40-3B	M40X1.5	40~40.4	18.4	7.7~10	

## PG THREAD ※ Without washer

UNIT : mm

Item No.	PG Thread	Mounting Hole	L1	Cable Range	Packing
EG-7-3A	PG7	12.5~12.8	7.9	1.6~2.6	washer are available to be assembled upon request.
EG-7LS-3A	PG7	12.5~12.8	7.9	1.6~2.6	
EG-9-3A	PG9	15.2~15.5	8.2	1.6~2.6	
EG-9L-3A	PG9	15.2~15.5	14.7	1.6~2.6	
EG-11-3A	PG11	18.6~18.9	7.9	1.6~2.6	
EG-11-3B	PG11	18.6~18.9	7.9	2.0~3.0	
EG-11-3C	PG11	18.6~18.9	7.9	3.0~4.2	
EG-11L-3A	PG11	18.6~18.9	14.9	1.6~2.6	
EG-11L-3B	PG11	18.6~18.9	14.9	2.0~3.0	
EG-11L-3C	PG11	18.6~18.9	14.9	3.0~4.2	
EG-13-3A	PG13.5	20.4~20.7	8.9	3.5~4.2	
EG-13L-3A	PG13.5	20.4~20.7	15.8	3.5~4.2	
EG-16-3A	PG16	22.5~22.8	9.8	2.0~3.0	
EG-16-3B	PG16	22.5~22.8	9.8	2.6~3.6	
EG-16-3C	PG16	22.5~22.8	9.8	3.0~4.2	
EG-16-3D	PG16	22.5~22.8	9.8	3.5~5.0	
EG-16-3E	PG16	22.5~22.8	9.8	3.5~5.2	
EG-21-3A	PG21	28.3~28.7	10.8	2.6~3.6	
EG-21-3B	PG21	28.3~28.7	10.8	3.6~5.2	
EG-21-3C	PG21	28.3~28.7	10.8	4.8~6.2	
EG-21-3D	PG21	28.3~28.7	10.8	6.2~8.0	
EG-29-3A	PG29	37~37.4	10.8	3.6~5.2	
EG-29-3B	PG29	37~37.4	10.8	4.8~6.2	
EG-29-3C	PG29	37~37.4	10.8	6.2~8.0	
EG-29-3D	PG29	37~37.4	10.8	7.7~10	
EG-36-3A	PG36	47~47.4	15.0	6.5~8.3	
EG-36-3B	PG36	47~47.4	15.0	7.7~10	



# 0613 KSS MULTI-HOLE NYLON CABLE GLAND ( 3 HOLES )

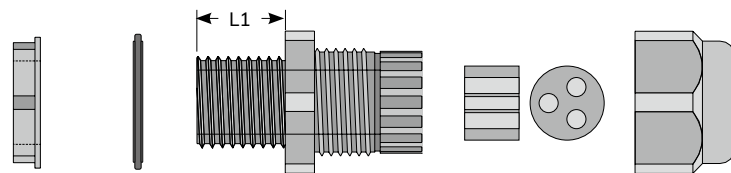

Part No.: Lock Nut L, Washer W, Body B, Claw, Seal, Nut N

## PF THREAD

Item No.	PF Thread	Mounting Hole	L1	Cable Range	Packing
AGJ-14-3A	PF1/4"	14~14.3	8.0	1.6~2.6	50pcs
AGJ-17-3A	PF3/8"	17~17.3	7.9	1.6~2.6	
AGJ-17-3B	PF3/8"	17~17.3	7.9	2.0~3.0	
AGJ-17-3C	PF3/8"	17~17.3	7.9	3.0~4.2	
AGJ-21-3A	PF1/2"	21~21.3	12.9	2.0~3.0	
AGJ-21-3B	PF1/2"	21~21.3	12.9	2.6~3.6	
AGJ-21-3C	PF1/2"	21~21.3	12.9	3.0~4.2	
AGJ-21-3D	PF1/2"	21~21.3	12.9	3.5~5.0	
AGJ-21-3E	PF1/2"	21~21.3	12.9	3.5~5.2	
AGJ-27-3A	PF3/4"	27~27.3	14.7	2.6~3.6	
AGJ-27-3B	PF3/4"	27~27.3	14.7	3.6~5.2	
AGJ-27-3C	PF3/4"	27~27.3	14.7	4.8~6.2	
AGJ-27-3D	PF3/4"	27~27.3	14.7	6.2~8.0	
AGJ-34-3A	PF1"	34~34.4	14.7	3.6~5.2	25pcs
AGJ-34-3B	PF1"	34~34.4	14.7	4.8~6.2	
AGJ-34-3C	PF1"	34~34.4	14.7	6.2~8.0	
AGJ-34-3D	PF1"	34~34.4	14.7	7.7~10	

## NPT THREAD ※ Without washer and lock nut UNIT : mm

Item No.	NPT Thread	Mounting Hole	L1	Cable Range	Packing
NPT-14-3A	1/4"-18 NPT	13.2~13.5	7.8	1.6~2.6	50pcs
NPT-38-3A	3/8"-18 NPT	16.7~17.0	14.6	1.6~2.6	
NPT-38-3B	3/8"-18 NPT	16.7~17.0	14.6	2.0~3.0	
NPT-38-3C	3/8"-18 NPT	16.7~17.0	14.6	3.0~4.2	
NPT-12-3A	1/2"-14 NPT	21.2~21.5	12.9	2.0~3.0	
NPT-12-3B	1/2"-14 NPT	21.2~21.5	12.9	2.6~3.6	
NPT-12-3C	1/2"-14 NPT	21.2~21.5	12.9	3.0~4.2	
NPT-12-3D	1/2"-14 NPT	21.2~21.5	12.9	3.5~5.0	
NPT-12-3E	1/2"-14 NPT	21.2~21.5	12.9	3.5~5.2	
NPT-34-3A	3/4"-14 NPT	26.3~26.6	14.5	2.6~3.6	
NPT-34-3B	3/4"-14 NPT	26.3~26.6	14.5	3.6~5.2	
NPT-34-3C	3/4"-14 NPT	26.3~26.6	14.5	4.8~6.2	
NPT-34-3D	3/4"-14 NPT	26.3~26.6	14.5	6.2~8.0	
NPT-1-3A	1"-11.5 NPT	33.2~33.6	14.9	3.6~5.2	25pcs
NPT-1-3B	1"-11.5 NPT	33.2~33.6	14.9	4.8~6.2	
NPT-1-3C	1"-11.5 NPT	33.2~33.6	14.9	6.2~8.0	
NPT-1-3D	1"-11.5 NPT	33.2~33.6	14.9	7.7~10	10pcs
NPT-114-3A	1 1/4"-11.5 NPT	41.9~42.3	18.2	6.5~8.3	
NPT-114-3B	1 1/4"-11.5 NPT	41.9~42.3	18.2	7.7~10	

Lock nut and washer are available to be assembled upon request.

Wiring Ducts

Cable Markers

Cable Ties

Wrapping Bands

Cable Clamps & Tie Mounts

Glands, Bushings

Conduits

Bushings

Wire Connectors

Tubes

Cable Clips

PCB Parts

Fasteners

# 0613 KSS MULTI-HOLE NYLON CABLE GLAND ( 4 HOLES)

- Material: UL94V-2 flame rated, UL approved Nylon 66, TPE for Seal, PVC for Washer.
- Color: Black, available in other colors.
- Multi-Hole Design organizes more than one cable within a gland.



## METRIC THREAD

Item No.	M Thread	Mounting Hole	L1	Cable Range	Packing
AG-12-4A	M12X1.25	12~12.3	7.9	1.3~2.3	50pcs
AG-12L-4A	M12X1.5	12~12.3	7.9	1.3~2.3	
AG-16-4A	M16X1.5	16~16.3	15.5	1.3~2.3	
AG-16-4B	M16X1.5	16~16.3	15.5	1.4~2.4	
AG-16-4C	M16X1.5	16~16.3	15.5	2.4~3.4	
AG-16S-4A	M16X1.5	16~16.3	10.0	1.3~2.3	
AG-16S-4B	M16X1.5	16~16.3	10.0	1.4~2.4	
AG-16S-4C	M16X1.5	16~16.3	10.0	2.4~3.4	
AG-20-4A	M20X1.5	20~20.3	15.0	1.4~2.4	
AG-20-4B	M20X1.5	20~20.3	15.0	1.6~2.5	
AG-20-4C	M20X1.5	20~20.3	15.0	2.4~3.4	
AG-20-4D	M20X1.5	20~20.3	15.0	2.5~3.6	
AG-20-4E	M20X1.5	20~20.3	15.0	3.0~4.2	
AG-20-4F	M20X1.5	20~20.3	15.0	3.4~4.8	
AG-20S-4A	M20X1.5	20~20.3	10.0	1.4~2.4	
AG-20S-4B	M20X1.5	20~20.3	10.0	1.6~2.5	
AG-20S-4C	M20X1.5	20~20.3	10.0	2.4~3.4	
AG-20S-4D	M20X1.5	20~20.3	10.0	2.5~3.6	
AG-20S-4E	M20X1.5	20~20.3	10.0	3.0~4.2	
AG-20S-4F	M20X1.5	20~20.3	10.0	3.4~4.8	
AG-25-4A	M25X1.5	25~25.4	15.2	1.6~2.5	
AG-25-4B	M25X1.5	25~25.4	15.2	2.0~3.1	
AG-25-4C	M25X1.5	25~25.4	15.2	2.5~3.6	
AG-25-4D	M25X1.5	25~25.4	15.2	3.0~4.1	
AG-25-4E	M25X1.5	25~25.4	15.2	3.4~4.8	
AG-25-4F	M25X1.5	25~25.4	15.2	3.8~5.2	
AG-25-4G	M25X1.5	25~25.4	15.2	5.6~7.3	
AG-25S-4A	M25X1.5	25~25.4	10.0	1.6~2.5	
AG-25S-4B	M25X1.5	25~25.4	10.0	2.0~3.1	
AG-25S-4C	M25X1.5	25~25.4	10.0	2.5~3.6	
AG-25S-4D	M25X1.5	25~25.4	10.0	3.0~4.1	
AG-25S-4E	M25X1.5	25~25.4	10.0	3.4~4.8	
AG-25S-4F	M25X1.5	25~25.4	10.0	3.8~5.2	
AG-25S-4G	M25X1.5	25~25.4	10.0	5.6~7.3	
AG-32-4A	M32X1.5	32~32.4	14.7	2.0~3.1	
AG-32-4B	M32X1.5	32~32.4	14.7	3.0~4.1	
AG-32-4C	M32X1.5	32~32.4	14.7	3.8~5.2	
AG-32-4D	M32X1.5	32~32.4	14.7	5.6~7.3	
AG-32-4E	M32X1.5	32~32.4	14.7	7.0~9.0	
AG-40-4A	M40X1.5	40~40.4	18.4	10~12	
					25pcs
					10pcs

## PG THREAD ※ Without washer

UNIT : mm

Item No.	PG Thread	Mounting Hole	L1	Cable Range	Packing
EG-7-4A	PG7	12.5~12.8	7.9	1.3~2.3	50pcs
EG-7LS-4A	PG7	12.5~12.8	7.9	1.3~2.3	
EG-9-4A	PG9	15.2~15.5	8.2	1.3~2.3	
EG-9L-4A	PG9	15.2~15.5	14.7	1.3~2.3	
EG-11-4A	PG11	18.6~18.9	7.9	1.3~2.3	
EG-11-4B	PG11	18.6~18.9	7.9	1.4~2.4	
EG-11-4C	PG11	18.6~18.9	7.9	2.4~3.4	
EG-11L-4A	PG11	18.6~18.9	14.9	1.3~2.3	
EG-11L-4B	PG11	18.6~18.9	14.9	1.4~2.4	
EG-11L-4C	PG11	18.6~18.9	14.9	2.4~3.4	
EG-13-4A	PG13.5	20.4~20.7	8.9	3.2~4.2	
EG-13L-4A	PG13.5	20.4~20.7	15.8	3.2~4.2	
EG-16-4A	PG16	22.5~22.8	9.8	1.4~2.4	
EG-16-4B	PG16	22.5~22.8	9.8	1.6~2.5	
EG-16-4C	PG16	22.5~22.8	9.8	2.4~3.4	
EG-16-4D	PG16	22.5~22.8	9.8	2.5~3.6	
EG-16-4E	PG16	22.5~22.8	9.8	3.0~4.2	
EG-16-4F	PG16	22.5~22.8	9.8	3.4~4.8	
EG-21-4A	PG21	28.3~28.7	10.8	1.6~2.5	
EG-21-4B	PG21	28.3~28.7	10.8	2.0~3.1	
EG-21-4C	PG21	28.3~28.7	10.8	2.5~3.6	
EG-21-4D	PG21	28.3~28.7	10.8	3.0~4.1	
EG-21-4E	PG21	28.3~28.7	10.8	3.4~4.8	
EG-21-4F	PG21	28.3~28.7	10.8	3.8~5.2	
EG-21-4G	PG21	28.3~28.7	10.8	5.6~7.3	
EG-29-4A	PG29	37~37.4	10.8	2.0~3.1	
EG-29-4B	PG29	37~37.4	10.8	3.0~4.1	
EG-29-4C	PG29	37~37.4	10.8	3.8~5.2	
EG-29-4D	PG29	37~37.4	10.8	5.6~7.3	
EG-29-4E	PG29	37~37.4	10.8	7.0~9.0	
EG-36-4A	PG36	47~47.4	15.0	10~12	
					25pcs
					10pcs

washer are available to be assembled upon request.

50pcs

25pcs

10pcs

# 0613 KSS MULTI-HOLE NYLON CABLE GLAND ( 4 HOLES)

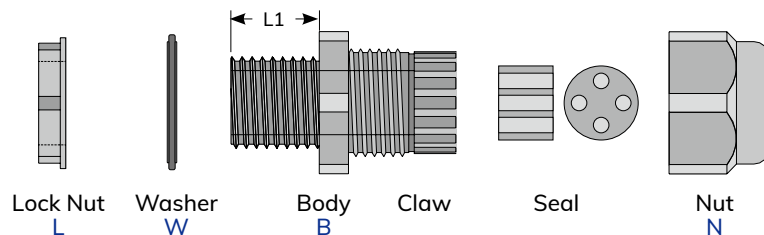

Part No.:

## PF THREAD

Item No.	PF Thread	Mounting Hole	L1	Cable Range	Packing
AGJ-14-4A	PF1/4"	14~14.3	8.0	1.3~2.3	50pcs
AGJ-17-4A	PF3/8"	17~17.3	7.9	1.3~2.3	
AGJ-17-4B	PF3/8"	17~17.3	7.9	1.4~2.4	
AGJ-17-4C	PF3/8"	17~17.3	7.9	2.4~3.4	
AGJ-21-4A	PF1/2"	21~21.3	12.9	1.4~2.4	
AGJ-21-4B	PF1/2"	21~21.3	12.9	1.6~2.5	
AGJ-21-4C	PF1/2"	21~21.3	12.9	2.4~3.4	
AGJ-21-4D	PF1/2"	21~21.3	12.9	2.5~3.6	
AGJ-21-4E	PF1/2"	21~21.3	12.9	3.0~4.2	
AGJ-21-4F	PF1/2"	21~21.3	12.9	3.4~4.8	
AGJ-27-4A	PF3/4"	27~27.3	14.7	1.6~2.5	
AGJ-27-4B	PF3/4"	27~27.3	14.7	2.0~3.1	
AGJ-27-4C	PF3/4"	27~27.3	14.7	2.5~3.6	
AGJ-27-4D	PF3/4"	27~27.3	14.7	3.0~4.1	
AGJ-27-4E	PF3/4"	27~27.3	14.7	3.4~4.8	
AGJ-27-4F	PF3/4"	27~27.3	14.7	3.8~5.2	
AGJ-27-4G	PF3/4"	27~27.3	14.7	5.6~7.3	
AGJ-34-4A	PF1"	34~34.4	14.7	2.0~3.1	25pcs
AGJ-34-4B	PF1"	34~34.4	14.7	3.0~4.1	
AGJ-34-4C	PF1"	34~34.4	14.7	3.8~5.2	
AGJ-34-4D	PF1"	34~34.4	14.7	5.6~7.3	
AGJ-34-4E	PF1"	34~34.4	14.7	7.0~9.0	

## NPT THREAD ※ Without washer and lock nut UNIT : mm

Item No.	NPT Thread	Mounting Hole	L1	Cable Range	Packing
NPT-14-4A	1/4"-18 NPT	13.2~13.5	7.8	1.3~2.3	50pcs
NPT-38-4A	3/8"-18 NPT	16.7~17.0	14.6	1.3~2.3	
NPT-38-4B	3/8"-18 NPT	16.7~17.0	14.6	1.4~2.4	
NPT-38-4C	3/8"-18 NPT	16.7~17.0	14.6	2.4~3.4	
NPT-12-4A	1/2"-14 NPT	21.2~21.5	12.9	1.4~2.4	
NPT-12-4B	1/2"-14 NPT	21.2~21.5	12.9	1.6~2.5	
NPT-12-4C	1/2"-14 NPT	21.2~21.5	12.9	2.4~3.4	
NPT-12-4D	1/2"-14 NPT	21.2~21.5	12.9	2.5~3.6	
NPT-12-4E	1/2"-14 NPT	21.2~21.5	12.9	3.0~4.2	
NPT-12-4F	1/2"-14 NPT	21.2~21.5	12.9	3.4~4.8	
NPT-34-4A	3/4"-14 NPT	26.3~26.6	14.5	1.6~2.5	
NPT-34-4B	3/4"-14 NPT	26.3~26.6	14.5	2.0~3.1	
NPT-34-4C	3/4"-14 NPT	26.3~26.6	14.5	2.5~3.6	
NPT-34-4D	3/4"-14 NPT	26.3~26.6	14.5	3.0~4.1	
NPT-34-4E	3/4"-14 NPT	26.3~26.6	14.5	3.4~4.8	
NPT-34-4F	3/4"-14 NPT	26.3~26.6	14.5	3.8~5.2	
NPT-34-4G	3/4"-14 NPT	26.3~26.6	14.5	5.6~7.3	
NPT-1-4A	1"-11.5 NPT	33.2~33.6	14.9	2.0~3.1	25pcs
NPT-1-4B	1"-11.5 NPT	33.2~33.6	14.9	3.0~4.1	
NPT-1-4C	1"-11.5 NPT	33.2~33.6	14.9	3.8~5.2	
NPT-1-4D	1"-11.5 NPT	33.2~33.6	14.9	5.6~7.3	
NPT-1-4E	1"-11.5 NPT	33.2~33.6	14.9	7.0~9.0	
NPT-114-4A	1 1/4"-11.5 NPT	41.9~42.3	18.2	10~12	10pcs

Lock nut and washer are available to be assembled upon request.

- Wiring Ducts
- Cable Markers
- Cable Ties
- Wrapping Bands
- Cable Clamps & Tie Mounts
- Glands, Bushings**
- Conduits
- Bushings
- Wire Connectors
- Tubes
- Cable Clips
- PCB Parts
- Fasteners

# 0613 KSS MULTI-HOLE NYLON CABLE GLAND ( 5 HOLES)

- Material: UL94V-2 flame rated, UL approved Nylon 66, TPE for Seal, PVC for Washer.
- Color: Black, available in other colors.
- Multi-Hole Design organizes more than one cable within a gland.



## METRIC THREAD

Item No.	M Thread	Mounting Hole	L1	Cable Range	Packing
AG-16-5A	M16X1.5	16~16.3	15.5	2.0~2.8	50pcs
AG-16S-5A	M16X1.5	16~16.3	10.0	2.0~2.8	
AG-20-5A	M20X1.5	20~20.3	15.0	1.3~2.0	
AG-20-5B	M20X1.5	20~20.3	15.0	2.0~2.8	
AG-20-5C	M20X1.5	20~20.3	15.0	2.0~3.1	
AG-20-5D	M20X1.5	20~20.3	15.0	3.0~4.1	
AG-20S-5A	M20X1.5	20~20.3	10.0	1.3~2.0	
AG-20S-5B	M20X1.5	20~20.3	10.0	2.0~2.8	
AG-20S-5C	M20X1.5	20~20.3	10.0	2.0~3.1	
AG-20S-5D	M20X1.5	20~20.3	10.0	3.0~4.1	
AG-25-5A	M25X1.5	25~25.4	15.2	1.3~2.0	
AG-25-5B	M25X1.5	25~25.4	15.2	2.0~3.1	
AG-25-5C	M25X1.5	25~25.4	15.2	2.6~3.6	
AG-25-5D	M25X1.5	25~25.4	15.2	3.0~4.1	
AG-25-5E	M25X1.5	25~25.4	15.2	3.6~4.6	
AG-25-5F	M25X1.5	25~25.4	15.2	4.6~6.0	
AG-25S-5A	M25X1.5	25~25.4	10.0	1.3~2.0	
AG-25S-5B	M25X1.5	25~25.4	10.0	2.0~3.1	
AG-25S-5C	M25X1.5	25~25.4	10.0	2.6~3.6	
AG-25S-5D	M25X1.5	25~25.4	10.0	3.0~4.1	
AG-25S-5E	M25X1.5	25~25.4	10.0	3.6~4.6	
AG-25S-5F	M25X1.5	25~25.4	10.0	4.6~6.0	
AG-32-5A	M32X1.5	32~32.4	14.7	2.6~3.6	25pcs
AG-32-5B	M32X1.5	32~32.4	14.7	3.6~4.6	
AG-32-5C	M32X1.5	32~32.4	14.7	4.6~6.0	
AG-32-5D	M32X1.5	32~32.4	14.7	6.0~8.0	
AG-40-5A	M40X1.5	40~40.4	18.4	6.5~8.3	10pcs

## PG THREAD ※ Without washer

UNIT : mm

Item No.	PG Thread	Mounting Hole	L1	Cable Range	Packing	
EG-11-5A	PG11	18.6~18.9	7.9	2.0~2.8	50pcs	
EG-11L-5A	PG11	18.6~18.9	14.9	2.0~2.8		
EG-16-5A	PG16	22.5~22.8	9.8	1.3~2.0		
EG-16-5B	PG16	22.5~22.8	9.8	2.0~2.8		
EG-16-5C	PG16	22.5~22.8	9.8	2.0~3.1		
EG-16-5D	PG16	22.5~22.8	9.8	3.0~4.1		
EG-21-5A	PG21	28.3~28.7	10.8	1.3~2.0		
EG-21-5B	PG21	28.3~28.7	10.8	2.0~3.1		
EG-21-5C	PG21	28.3~28.7	10.8	2.6~3.6		
EG-21-5D	PG21	28.3~28.7	10.8	3.0~4.1		
EG-21-5E	PG21	28.3~28.7	10.8	3.6~4.6		
EG-21-5F	PG21	28.3~28.7	10.8	4.6~6.0		
EG-29-5A	PG29	37~37.4	10.8	2.6~3.6		25pcs
EG-29-5B	PG29	37~37.4	10.8	3.6~4.6		
EG-29-5C	PG29	37~37.4	10.8	4.6~6.0		
EG-29-5D	PG29	37~37.4	10.8	6.0~8.0		
EG-36-5A	PG36	47~47.4	15.0	6.5~8.3	10pcs	

washer are available to be assembled upon request.

# 0613 KSS MULTI-HOLE NYLON CABLE GLAND ( 5 HOLES)

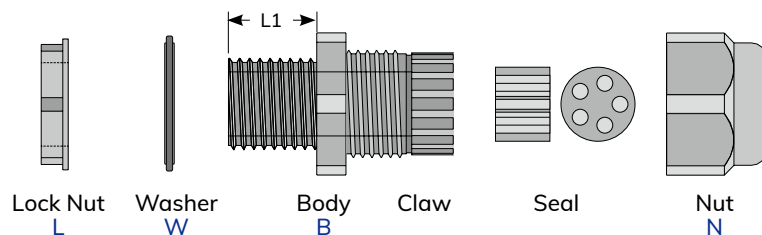

Part No.:

## PF THREAD

Item No.	PF Thread	Mounting Hole	L1	Cable Range	Packing
AGJ-17-5A	PF3/8"	17~17.3	7.9	2.0~2.8	50pcs
AGJ-21-5A	PF1/2"	21~21.3	12.9	1.3~2.0	
AGJ-21-5B	PF1/2"	21~21.3	12.9	2.0~2.8	
AGJ-21-5C	PF1/2"	21~21.3	12.9	2.0~3.1	
AGJ-21-5D	PF1/2"	21~21.3	12.9	3.0~4.1	
AGJ-27-5A	PF3/4"	27~27.3	14.7	1.3~2.0	
AGJ-27-5B	PF3/4"	27~27.3	14.7	2.0~3.1	
AGJ-27-5C	PF3/4"	27~27.3	14.7	2.6~3.6	
AGJ-27-5D	PF3/4"	27~27.3	14.7	3.0~4.1	
AGJ-27-5E	PF3/4"	27~27.3	14.7	3.6~4.6	
AGJ-27-5F	PF3/4"	27~27.3	14.7	4.6~6.0	
AGJ-34-5A	PF1"	34~34.4	14.7	2.6~3.6	
AGJ-34-5B	PF1"	34~34.4	14.7	3.6~4.6	
AGJ-34-5C	PF1"	34~34.4	14.7	4.6~6.0	
AGJ-34-5D	PF1"	34~34.4	14.7	6.0~8.0	

## NPT THREAD ※ Without washer and lock nut UNIT : mm

Item No.	NPT Thread	Mounting Hole	L1	Cable Range	Packing
NPT-38-5A	3/8"-18 NPT	16.7~17.0	14.6	2.0~2.8	50pcs
NPT-12-5A	1/2"-14 NPT	21.2~21.5	12.9	1.3~2.0	
NPT-12-5B	1/2"-14 NPT	21.2~21.5	12.9	2.0~2.8	
NPT-12-5C	1/2"-14 NPT	21.2~21.5	12.9	2.0~3.1	
NPT-12-5D	1/2"-14 NPT	21.2~21.5	12.9	3.0~4.1	
NPT-34-5A	3/4"-14 NPT	26.3~26.6	14.5	1.3~2.0	
NPT-34-5B	3/4"-14 NPT	26.3~26.6	14.5	2.0~3.1	
NPT-34-5C	3/4"-14 NPT	26.3~26.6	14.5	2.6~3.6	
NPT-34-5D	3/4"-14 NPT	26.3~26.6	14.5	3.0~4.1	
NPT-34-5E	3/4"-14 NPT	26.3~26.6	14.5	3.6~4.6	
NPT-34-5F	3/4"-14 NPT	26.3~26.6	14.5	4.6~6.0	
NPT-1-5A	1"-11.5 NPT	33.2~33.6	14.9	2.6~3.6	
NPT-1-5B	1"-11.5 NPT	33.2~33.6	14.9	3.6~4.6	
NPT-1-5C	1"-11.5 NPT	33.2~33.6	14.9	4.6~6.0	
NPT-1-5D	1"-11.5 NPT	33.2~33.6	14.9	6.0~8.0	
NPT-114-5A	1 1/4"-11.5 NPT	41.9~42.3	18.2	6.5~8.3	10pcs

Lock nut and washer are available to be assembled upon request.

# 0613 KSS MULTI-HOLE NYLON CABLE GLAND ( 6 HOLES )

- Material: UL94V-2 flame rated, UL approved Nylon 66, TPE for Seal, PVC for Washer.
- Color: Black, available in other colors.
- Multi-Hole Design organizes more than one cable within a gland.

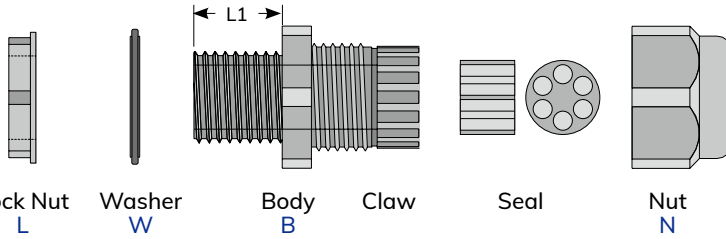

Part No.:

## METRIC THREAD

Item No.	M Thread	Mounting Hole	L1	Cable Range	Packing
AG-16-6A	M16X1.5	16~16.3	15.5	1.4~2.1	50pcs
AG-16S-6A	M16X1.5	16~16.3	10.0	1.4~2.1	
AG-20-6A	M20X1.5	20~20.3	15.0	1.3~2.0	
AG-20-6B	M20X1.5	20~20.3	15.0	2.0~3.0	
AG-20S-6A	M20X1.5	20~20.3	10.0	1.3~2.0	
AG-20S-6B	M20X1.5	20~20.3	10.0	2.0~3.0	
AG-25-6A	M25X1.5	25~25.4	15.2	1.3~2.0	
AG-25-6B	M25X1.5	25~25.4	15.2	2.0~3.0	
AG-25-6C	M25X1.5	25~25.4	15.2	2.6~3.6	
AG-25-6D	M25X1.5	25~25.4	15.2	3.6~5.2	
AG-25S-6A	M25X1.5	25~25.4	10.0	1.3~2.0	25pcs
AG-25S-6B	M25X1.5	25~25.4	10.0	2.0~3.0	
AG-25S-6C	M25X1.5	25~25.4	10.0	2.6~3.6	
AG-25S-6D	M25X1.5	25~25.4	10.0	3.6~5.2	
AG-32-6A	M32X1.5	32~32.4	14.7	2.6~3.6	25pcs
AG-32-6B	M32X1.5	32~32.4	14.7	3.6~5.2	
AG-32-6C	M32X1.5	32~32.4	14.7	5.6~7.0	

## PF THREAD

UNIT : mm

Item No.	PG Thread	Mounting Hole	L1	Cable Range	Packing	
AGJ-17-6A	PF3/8"	17~17.3	7.9	1.4~2.1	50pcs	
AGJ-21-6A	PF1/2"	21~21.3	12.9	1.3~2.0		
AGJ-21-6B	PF1/2"	21~21.3	12.9	2.0~3.0		
AGJ-27-6A	PF3/4"	27~27.3	14.7	1.3~2.0		
AGJ-27-6B	PF3/4"	27~27.3	14.7	2.0~3.0		
AGJ-27-6C	PF3/4"	27~27.3	14.7	2.6~3.6		
AGJ-27-6D	PF3/4"	27~27.3	14.7	3.6~5.2		
AGJ-34-6A	PF1"	34~34.4	14.7	2.6~3.6		25pcs
AGJ-34-6B	PF1"	34~34.4	14.7	3.6~5.2		
AGJ-34-6C	PF1"	34~34.4	14.7	5.6~7.0		

## PG THREAD \* Without washer

Item No.	PG Thread	Mounting Hole	L1	Cable Range	Packing	
EG-11-6A	PG11	18.6~18.9	7.9	1.4~2.1	50pcs	
EG-11L-6A	PG11	18.6~18.9	14.9	1.4~2.1		
EG-16-6A	PG16	22.5~22.8	9.8	1.3~2.0		
EG-16-6B	PG16	22.5~22.8	9.8	2.0~3.0		
EG-21-6A	PG21	28.3~28.7	10.8	1.3~2.0		
EG-21-6B	PG21	28.3~28.7	10.8	2.0~3.0		
EG-21-6C	PG21	28.3~28.7	10.8	2.6~3.6		
EG-21-6D	PG21	28.3~28.7	10.8	3.6~5.2		
EG-29-6A	PG29	37~37.4	10.8	2.6~3.6		25pcs
EG-29-6B	PG29	37~37.4	10.8	3.6~5.2		
EG-29-6C	PG29	37~37.4	10.8	5.6~7.0		

## NPT THREAD \* Without washer and lock nut

Item No.	NPT Thread	Mounting Hole	L1	Cable Range	Packing	
NPT-38-6A	3/8"-18 NPT	16.7~17.0	14.6	1.4~2.1	50pcs	
NPT-12-6A	1/2"-14 NPT	21.2~21.5	12.9	1.3~2.0		
NPT-12-6B	1/2"-14 NPT	21.2~21.5	12.9	2.0~3.0		
NPT-34-6A	3/4"-14 NPT	26.3~26.6	14.5	1.3~2.0		
NPT-34-6B	3/4"-14 NPT	26.3~26.6	14.5	2.0~3.0		
NPT-34-6C	3/4"-14 NPT	26.3~26.6	14.5	2.6~3.6		
NPT-34-6D	3/4"-14 NPT	26.3~26.6	14.5	3.6~5.2		
NPT-1-6A	1"-11.5 NPT	33.2~33.6	14.9	2.6~3.6		25pcs
NPT-1-6B	1"-11.5 NPT	33.2~33.6	14.9	3.6~5.2		
NPT-1-6C	1"-11.5 NPT	33.2~33.6	14.9	5.6~7.0		

# 0613 KSS MULTI-HOLE NYLON CABLE GLAND ( 7 HOLES )



- Material: UL94V-2 flame rated, UL approved Nylon 66, TPE for Seal, PVC for Washer.
- Color: Black, available in other colors.
- Multi-Hole Design organizes more than one cable within a gland.

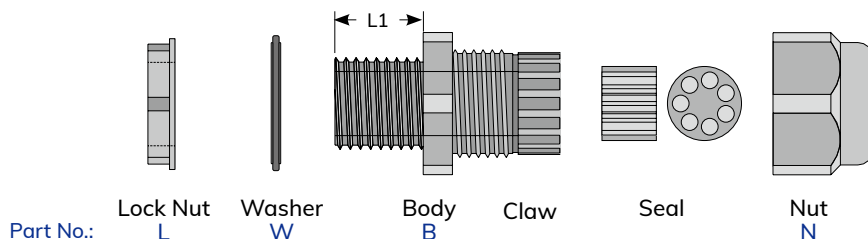

## METRIC THREAD

Item No.	M Thread	Mounting Hole	L1	Cable Range	Packing
AG-20-7A	M20X1.5	20~20.3	15.0	1.3~2.0	50pcs
AG-20-7B	M20X1.5	20~20.3	15.0	2.0~3.0	
AG-20S-7A	M20X1.5	20~20.3	10.0	1.3~2.0	
AG-20S-7B	M20X1.5	20~20.3	10.0	2.0~3.0	
AG-25-7A	M25X1.5	25~25.4	15.2	1.3~2.0	
AG-25-7B	M25X1.5	25~25.4	15.2	2.0~3.0	
AG-25-7C	M25X1.5	25~25.4	15.2	2.6~3.6	
AG-25S-7A	M25X1.5	25~25.4	10.0	1.3~2.0	
AG-25S-7B	M25X1.5	25~25.4	10.0	2.0~3.0	
AG-25S-7C	M25X1.5	25~25.4	10.0	2.6~3.6	
AG-32-7A	M32X1.5	32~32.4	14.7	2.6~3.6	25pcs
AG-32-7B	M32X1.5	32~32.4	14.7	4.6~6.0	

## PF THREAD

UNIT : mm

Item No.	PG Thread	Mounting Hole	L1	Cable Range	Packing
AGJ-21-7A	PF1/2"	21~21.3	12.9	1.3~2.0	50pcs
AGJ-21-7B	PF1/2"	21~21.3	12.9	2.0~3.0	
AGJ-27-7A	PF3/4"	27~27.3	14.7	1.3~2.0	
AGJ-27-7B	PF3/4"	27~27.3	14.7	2.0~3.0	
AGJ-27-7C	PF3/4"	27~27.3	14.7	2.6~3.6	
AGJ-34-7A	PF1"	34~34.4	14.7	2.6~3.6	
AGJ-34-7B	PF1"	34~34.4	14.7	4.6~6.0	

## PG THREAD ※ Without washer

Item No.	PG Thread	Mounting Hole	L1	Cable Range	Packing
EG-16-7A	PG16	22.5~22.8	9.8	1.3~2.0	50pcs
EG-16-7B	PG16	22.5~22.8	9.8	2.0~3.0	
EG-21-7A	PG21	28.3~28.7	10.8	1.3~2.0	
EG-21-7B	PG21	28.3~28.7	10.8	2.0~3.0	
EG-21-7C	PG21	28.3~28.7	10.8	2.6~3.6	25pcs
EG-29-7A	PG29	37~37.4	10.8	2.6~3.6	
EG-29-7B	PG29	37~37.4	10.8	4.6~6.0	

washer are available to be assembled upon request

## NPT THREAD ※ Without washer and lock nut

Item No.	NPT Thread	Mounting Hole	L1	Cable Range	Packing
NPT-12-7A	1/2"-14 NPT	21.2~21.5	12.9	1.3~2.0	50pcs
NPT-12-7B	1/2"-14 NPT	21.2~21.5	12.9	2.0~3.0	
NPT-34-7A	3/4"-14 NPT	26.3~26.6	14.5	1.3~2.0	
NPT-34-7B	3/4"-14 NPT	26.3~26.6	14.5	2.0~3.0	
NPT-34-7C	3/4"-14 NPT	26.3~26.6	14.5	2.6~3.6	
NPT-1-7A	1"-11.5 NPT	33.2~33.6	14.9	2.6~3.6	
NPT-1-7B	1"-11.5 NPT	33.2~33.6	14.9	4.6~6.0	

washer and lock nut are available upon request

- Wiring Ducts
- Cable Markers
- Cable Ties
- Wrapping Bands
- Cable Clamps & Tie Mounts
- Glands, Bushings
- Conduits
- Bushings
- Wire Connectors
- Tubes
- Cable Clips
- PCB Parts
- Fasteners

# 0611 KSS NYLON LOCK NUT

- Material: UL94V-2 flame rated, UL approved Nylon 66.
- Color: Black, available in other colors.

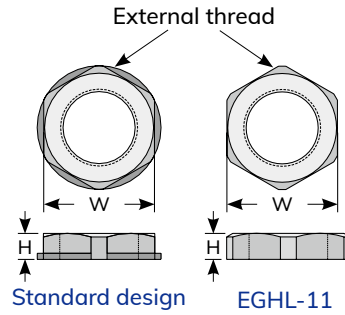

## METRIC THREAD

Item No.	External thread	W	H	Packing
AGL-12	M12x1.25	17.0	5.2	50pcs
AGL-12L	M12x1.5	17.0	5.2	
AGL-16	M16x1.5	21.8	5.2	
AGL-20	M20x1.5	26.6	6.0	
AGL-25	M25x1.5	33.0	6.7	25pcs
AGL-32	M32x1.5	41.7	8.0	
AGL-40	M40x1.5	48.3	9.0	10pcs
AGL-50	M50x1.5	58.8	9.8	
AGL-63	M61x1.5	66.0	10.8	
AGL-63L	M63x1.5	73.0	11.0	

## PF THREAD

Item No.	External thread	W	H	Packing
AGL-20F	PF 1/2"	26.2	6.6	50pcs
AGJL-14	PF 1/4"	17.0	5.1	50pcs
AGJL-17	PF 3/8"	22.0	5.2	
AGJL-21	PF 1/2"	27.0	6.1	
AGJL-58	PF 5/8"	26.8	6.0	
AGJL-27	PF 3/4"	33.0	7.1	25pcs
AGJL-34	PF 1"	41.6	8.1	
AGJL-112	PF 1 1/2"	58.5	9.8	10pcs
AGJL-2	PF 2"	72.3	10.8	

## PG THREAD

Item No.	External thread	W	H	Packing
EGL-7	PG7	19.1	5.1	50pcs
EGL-7LS	PG7	15.6	5.1	
EGL-9	PG9	21.0	5.1	
EGL-11	PG11	24.0	5.1	
EGL-13.5	PG13.5	27.0	6.1	
EGL-16	PG16	30.0	6.1	
EGL-21	PG21	36.0	7.1	25pcs
EGL-29	PG29	46.2	8.0	
EGL-36	PG36	59.0	7.8	10pcs
EGL-42	PG42	65.0	7.8	
EGL-48	PG48	69.5	7.8	
EGHL-11	PG11	23.9	5.2	50pcs

## NPT THREAD

Item No.	External thread	W	H	Packing
NPTL-14	NPT 1/4"	17.0	5.1	50pcs
NPTL-38	NPT 3/8"	22.0	5.2	
NPTL-12	NPT 1/2"	27.0	6.1	
NPTL-34	NPT 3/4"	33.0	7.1	
NPTL-1	NPT 1"	42.2	8.1	25pcs
NPTL-114	NPT 1 1/4"	48.8	9.0	10pcs

# 0612 KSS NYLON CABLE GLAND SEALING PLUG

- Material: UL94V-2 flame rated, UL approved Nylon 66.
- Color: Black
- Insert into the cable gland before any assembly to avoid dust and water

UNIT : mm

Item No.	O.D	O.D1	H	Suitable for cable gland	Packing
BPA-060	10.2	6.0	15.5	AG-12, EG-7, AGJ-14, NPT-14	50pcs
BPA-095	15.6	9.5	15.5	AG-16, EG-11, EG-13.5, AGJ-17, NPT-38	
BPA-135	19.6	13.5	16.5	AG-20, EG-16, AGJ-21, NPT-12	
BPA-175	24.4	17.5	17.0	AG-25, EG-21, AGJ-27, NPT-34	
BPA-245	32.5	24.5	17.5	AG-32, EG-29, AGJ-34, NPT-1	25pcs
BPA-315	41.5	31.5	18.0	AG-40, NPT-114, EG-36	10pcs
BPA-389	47.2	38.9	18.0	AG-50, EG-42	
BPA-435	52.5	43.5	19.0	AG-63	

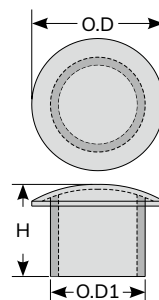



# 0612 KSS NYLON CABLE GLAND SEALING PLUG

- Material: UL94V-2 flame rated, UL approved Nylon 66.
- Color: Black.
- Insert into the cable gland before any assembly to avoid dust and water.

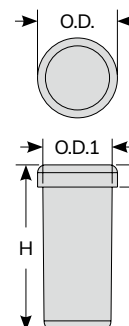

UNIT : mm

Item No.	O.D.	O.D.1	H	Packing
BPB-020	3.0	2.0	15	100pcs
BPB-025	3.5	2.5	15	
BPB-030	4.0	3.0	15	
BPB-035	4.5	3.5	15	
BPB-043	5.3	4.3	15	
BPB-050	6.0	5.0	15	
BPB-062	7.2	6.2	15	
BPB-072	8.2	7.2	15	
BPB-080	9.0	8.0	15	
BPB-090	10.0	9.0	15	
BPB-100	11.0	10.0	15	
BPB-120	13.0	12.0	15	
BPB-130	14.0	13.0	15	

# 0614 KSS WASHER

- Material: PVC
- Color: Black
- Function: To be used with cable gland to get effect of non-slip, seamless and water-resistant.

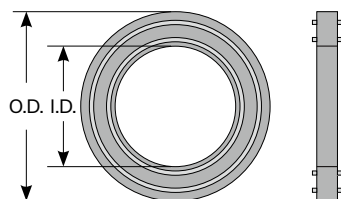

UNIT : mm

Item No.	I.D.	O.D.	Packing
AGW-12	10.5	17.0	50pcs
AGW-16	16.0	24.0	
AGW-20	20.0	28.0	
AGW-25	25.0	35.0	
AGW-32	32.0	44.0	25pcs
AGW-40	40.0	52.0	10pcs
AGW-50	50.0	65.0	
AGW-63	58.5	69.5	
AGW-63L	62.0	81.4	

Item No.	I.D.	O.D.	Packing	
EGW-7	10.5	17.0	50pcs	
EGW-9	15.0	22.0		
EGW-11	18.0	26.0		
EGW-13.5	20.0	28.0		
EGW-16	22.5	29.5		
EGW-21	28.0	35.5		
EGW-29	37.0	45.0		25pcs
EGW-36	47.0	54.0		10pcs
EGW-42	54.0	65.0		
EGW-48	58.5	69.5		

Item No.	I.D.	O.D.	Packing
AGJW-14	13.0	18.0	50pcs
AGJW-17	16.0	24.0	
AGJW-21	20.0	28.0	
AGJW-27	25.0	35.0	
AGJW-34	32.0	44.0	25pcs
AGJW-112	50.0	65.0	10pcs
AGJW-2	58.5	69.5	

Item No.	I.D.	O.D.	Packing
NPTW-14	13.0	18.0	50pcs
NPTW-38	16.0	24.0	
NPTW-12	20.0	28.0	
NPTW-34	25.0	35.0	
NPTW-1	32.0	44.0	
NPTW-114	40.0	52.0	10pcs

Item No.	I.D.	O.D.	Packing
AGW-20F	20.0	28.0	50pcs

# 0613 KSS MULTI-HOLE SEAL

- Material: TPE
- Function: To be used with cable gland and gather various cables into it.

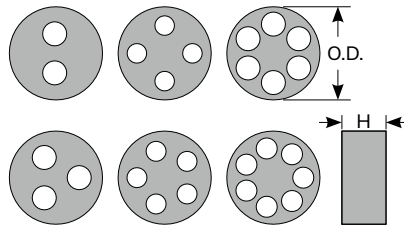

UNIT : mm

Item No.	Cable Range	O.D.	H	Suitable Cable Gland	Holes	Packing	Item No.	Cable Range	O.D.	H	Suitable Cable Gland	Holes	Packing
MH9-2A	2.0~3.1	9.0	7.3	AG-12、 EG-7、 AGJ-14、 NPT-14	2	50pcs	MH18-5A	1.3~2.0	17.5	9.0	AG-20、 EG-16、 AGJ-21、 NPT-12	5	
MH9-3A	1.6~2.6				3		MH18-5B	2.0~2.8					
MH9-4A	1.3~2.3				4		MH18-5C	2.0~3.1					
MH11-2A	2.0~3.1	11.0	8.0	EG-9	2		MH18-5D	3.0~4.1					
MH11-3A	1.6~2.6				3		MH18-6A	1.3~2.0					
MH11-4A	1.3~2.3				4		MH18-6B	2.0~3.0					
MH14-2A	1.6~2.6	14.0	9.2	AG-16、 EG-11、 AGJ-17、 NPT-38	2		MH18-7A	1.3~2.0				22.8	
MH14-2B	2.0~3.1				2		MH18-7B	2.0~3.0					
MH14-2C	3.0~4.1				3		MH23-2A	2.5~3.5					
MH14-3A	1.6~2.6						MH23-2B	3.3~4.3					
MH14-3B	2.0~3.0						MH23-2C	3.5~5.1					
MH14-3C	3.0~4.2				4		MH23-2D	4.3~6.1	2				
MH14-4A	1.3~2.3						MH23-2E	5.1~6.5					
MH14-4B	1.4~2.4						MH23-2F	6.4~8.7					
MH14-4C	2.4~3.4				5		EG-13.5	2	MH23-3A	2.6~3.6	3		
MH14-5A	2.0~2.8					MH23-3B			3.6~5.2				
MH14-6A	1.4~2.1	MH23-3C	4.8~6.2										
MH16-2A	3.5~5.2	16.0	8.4	EG-13.5	2	MH23-3D	6.2~8.0	4					
MH16-3A	3.5~5.0				3	MH23-4A	1.6~2.5						
MH16-4A	3.2~4.0				4	MH23-4B	2.0~3.1						
MH18-2A	1.6~2.6	17.5	9.0	AG-20、 EG-16、 AGJ-21、 NPT-12	2	MH23-4C	2.5~3.6	5					
MH18-2B	2.0~3.0					3	MH23-4D		3.0~4.1				
MH18-2C	2.5~3.5				MH23-4E		3.4~4.8						
MH18-2D	3.0~4.1				4		MH23-4F	3.8~5.2					
MH18-2E	3.3~4.3					MH23-4G	5.6~7.3						
MH18-2F	3.5~5.2					MH23-5A	1.3~2.0						
MH18-2G	4.3~6.1				5	MH23-5B	2.0~3.1						
MH18-3A	2.0~3.0					MH23-5C	2.6~3.6						
MH18-3B	2.6~3.6					MH23-5D	3.0~4.1						
MH18-3C	3.0~4.2				6	MH23-5E	3.6~4.6						
MH18-3D	3.5~5.0	MH23-5F	4.6~6.0										
MH18-3E	3.5~5.2	MH23-6A	1.3~2.0										
MH18-4A	1.4~2.4	6	MH23-6B	2.0~3.0									
MH18-4B	1.6~2.5		MH23-6C	2.6~3.6									
MH18-4C	2.4~3.4		MH23-6D	3.6~5.2									
MH18-4D	2.5~3.6	7	MH23-7A	1.3~2.0									
MH18-4E	3.0~4.2		MH23-7B	2.0~3.0									
MH18-4F	3.4~4.8		MH23-7C	2.6~3.6									

# 0613 KSS MULTI-HOLE SEAL

Item No.	Cable Range	O.D. D	H	Suitable Cable Gland	Holes	Packing	Item No.	Cable Range	O.D. D	H	Suitable Cable Gland	Holes	Packing
MH30-2A	3.6~5.2	30.4	14.4	AG-32、EG-29、AGJ-34、NPT-1	2	25pcs	MH30-6A	2.6~3.6	30.4	14.4	AG-32、EG-29、AGJ-34、NPT-1	6	25pcs
MH30-2B	5.1~6.5						MH30-6B	3.6~5.2					
MH30-2C	6.4~8.7						MH30-6C	5.6~7.0					
MH30-2D	7.7~10						MH30-7A	2.6~3.6					
MH30-3A	3.6~5.2				MH30-7B		4.6~6.0						
MH30-3B	4.8~6.2				MH39-2A		7.0~9.0						
MH30-3C	6.2~8.0				MH39-2B		11~13						
MH30-3D	7.7~10				MH39-3A		6.5~8.3						
MH30-4A	2.0~3.1				MH39-3B		7.7~10						
MH30-4B	3.0~4.1				MH39-4A		10~12						
MH30-4C	3.8~5.2				MH39-5A		6.5~8.3						
MH30-4D	5.6~7.3				MH42-2A		7.0~9.0						
MH30-4E	7.0~9.0				MH42-2B		11~13						
MH30-5A	2.6~3.6				MH42-3A		6.5~8.3						
MH30-5B	3.6~4.6				MH42-3B		7.7~10						
MH30-5C	4.6~6.0				MH42-4A		10~12						
MH30-5D	6.0~8.0	MH42-5A	6.5~8.3										

# 0613 KSS FLAT-HOLE SEAL

- Material: TPE
- Function: To be used with cable gland, for flat cable.
- Ordering information: While ordering cable gland with flat seal, please add the letter to the suffix part number of cable gland.
- For example:  
 AG-12 (CABLE GLAND) + MH9-FA (FLAT SEAL) = AG-12-FA  
 NPT-34 (CABLE GLAND) + MH23-FD (FLAT SEAL) = NPT-34-FD  
 EG-36 (CABLE GLAND) + MH39-FB (FLAT SEAL) = EG-36-FB

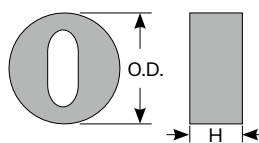

UNIT : mm

Item No.	Cable Range	O.D. D	H	Suitable Cable Gland	Packing	Item No.	Cable Range	O.D. D	H	Suitable Cable Gland	Packing
MH9-FA	6.9X2.3	9.0	7.3	AG-12、EG-7、AGJ-14、NPT-14	50pcs	MH23-FA	11.8X6.5	22.8	11.2	AG-25、EG-21、AGJ-27、NPT-34	50pcs
MH11-FA	6.9X2.3	11.0	8.0	EG-9		MH23-FB	11.8X7				
MH14-FA	6.9X2.3	14.0	9.2	AG-16、EG-11、AGJ-17、NPT-38		MH23-FC	13.8X6				
MH14-FB	9.8X6					MH23-FD	13.8x7				
MH16-FA	11.3X5	16.0	8.4	EG-13.5		MH30-FA	13.8x6	30.4	14.4	AG-32、EG-29、AGJ-34、NPT-1	25pcs
MH18-FA	9.8X6	17.5	9.0	AG-20、EG-16、AGJ-21、NPT-12		MH30-FB	13.8x7				
MH18-FB	11.3X5					MH30-FC	21.8X8				
MH18-FC	11.8X6.5					MH39-FA	28.3X10				
MH18-FD	11.8X7					MH39-FB	28.8X5.5				
MH18-FE	13.8X6	17.5	9.0	AG-20、EG-16、AGJ-21、NPT-12		MH42-FA	28.3X5.5	41.8	8.3	EG-36	10pcs
MH18-FF	13.8X7					MH42-FB	28.5X10				

# 0613 KSS MULTI-HOLE SEAL(3 HOLES)

**NEW**

- Material: TPE
- Function: To be used with cable gland and gather various cables into it.

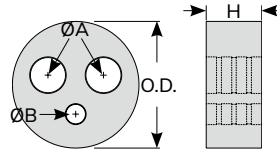

UNIT : mm

Item No.	Cable Range		O.D.	H	Suitable Cable Gland	Packing
	ØA	ØB				
MH30-3MA	10.7~8.5	5.9~5	30.3	14.4	AG-32、EG-29、AGJ-34、NPT-1	25pcs
MH39-3MA	10.7~8.5	5.9~5	38.8	17.0	AG-40、NPT-114	10pcs

- Wiring Ducts
- Cable Markers
- Cable Ties
- Wrapping Bands
- Cable Clamps & Tie Mounts
- Glands, Bushings**
- Conduits
- Bushings
- Wire Connectors
- Tubes
- Cable Clips
- PCB Parts
- Fasteners

# Conduits

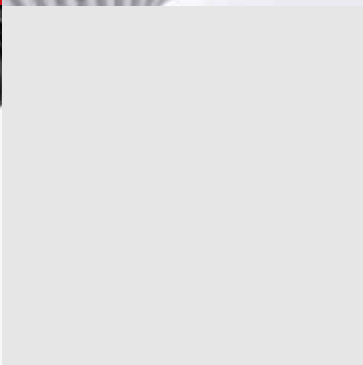
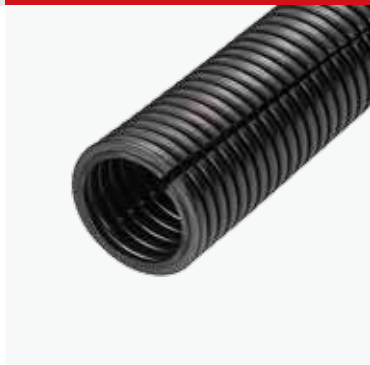
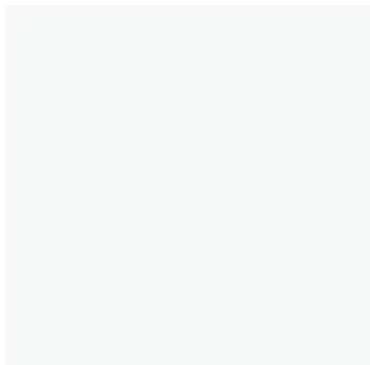

Wiring  
Ducts

Cable  
Markers

Cable  
Ties

Wrapping  
Bands

Cable Clamps  
& Ties

Glands,  
Bushings

**Conduits**

Bushings

Wire  
Connectors

Tubes

Cable  
Clips

PCB  
Parts

Fasteners

# 0615 KSS FLEXIBLE CONDUIT ADAPTOR

- Material: UL94V-2 flame rated, UL approved Nylon 66.
- Color: Grey
- Constructed of three parts to fix flexible conduit in control panel, machinery and apparatus.
- Application
  1. Mount body to pre-drilled panel hole.
  2. Insert conduit through nut.
  3. Insert conduit to claw and fix it with nut to complete works.
- ※ Available in LDPE material upon request.

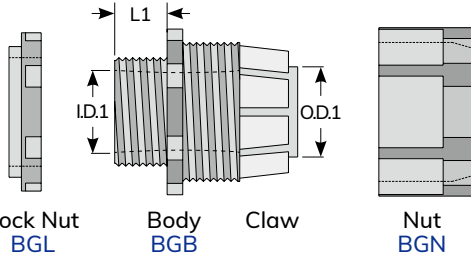

※Protection : IP55

UNIT : mm

Item No.	Thread	Thread O.D.	Mounting Hole	O.D.1	I.D.1	L1	Suitable Conduit	Packing
BG-10	M12X1.25	12.0	12+0.2	7.5	5.8	9.7	BG-10P	50pcs
BG-14		18.0	18+0.2	10.5	9.0	10.0	BG-14P	
BG-16		18.0	18+0.2	10.8	9.0	10.0	BG-16P	
BG-18	M16X1.5	16.0	16+0.2	13.3	10.8	9.7	BG-18P	
BG-20		21.0	21+0.2	14.7	12.9	10.0	BG-20P	
BG-22	M20X1.5	20.0	20+0.2	17.2	14.8	9.8	BG-22P	
BG-25	M25X1.5	25.0	25+0.3	18.9	16.6	11.4	BG-25P	
BG-26	M25X1.5	25.0	25+0.3	19.8	17.6	11.4	BG-26P	25pcs
BG-32		33.0	33+0.3	24.3	22.3	12.0	BG-32P	
BG-34	M34X1.5	34.0	32+0.3	28.6	25.5	11.3	BG-34P	
BG-40		39.5	39.5+0.3	31.6	29.0	11.3	BG-40P	10pcs
BG-42	M40X1.5	40.0	40+0.3	34.8	31.4	11.5	BG-42P	
BG-48		46.0	46+0.3	40.5	36.9	12.6	BG-48P	
BG-50		46.0	46+0.3	39.5	36.9	12.6	BG-50P	

# 0615 KSS FLEXIBLE CONDUIT ADAPTOR

- Material: UL94HB flame rated, UL approved ABS.
- Color: Grey

UNIT : mm

Item No.	TYPE	Suitable Conduit	Packing
FAM-18	Conduit to conduit connector	BG-18P	20pcs
FAM-22		BG-22P	
FAM-26		BG-26P	
FAM-34		BG-34P	
FAB-18	Conduit to junction box connector	BG-18P	
FAB-22		BG-22P	
FAB-26		BG-26P	
FAB-34	BG-34P		
FAP-18	Conduit to PVC pipe connector	BG-18P	
FAP-22		BG-22P	
FAP-26		BG-26P	
FAP-34		BG-34P	



# 0615 KSS WATERPROOF FLEXIBLE CONDUIT ADAPTOR

- Material: UL94V-2 flame rated, UL approved Nylon 66, TPE for Seal, PVC for Washer.
- Color: Black.
- Function: Fix flexible conduit and provide waterproof protection in control panel, machinery and apparatus.
- Application:

1. Mount body to pre-drilled panel hole.
2. Insert conduit through nut into seal and fix it by twisting nut.

※ Available to order the accessories separately. Follow the drawing and add the letter to the suffix part number, L for locknut, W for washer, B for body, S for seal, N for nut. For example, BML-18 if you would like to only order locknut for BM-18.

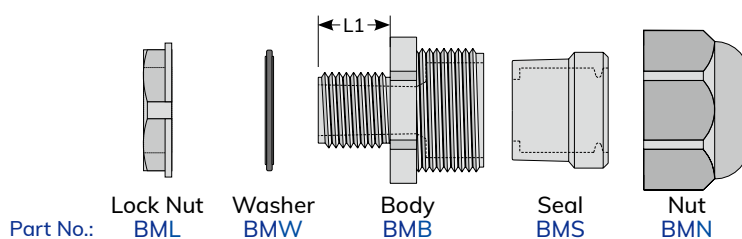

Item No.	Thread	Thread O.D.	Mounting Hole	L1	Suitable Conduit	Packing
BM-18	M16xP1.5	16	16+0.2	15.0	BG-16P、BG-18P、CRS-11P、CRS-13P、PA-12、CF-18P	50pcs
BM-22	M20xP1.5	20	20+0.2	15.0	BG-20P、BG-22P、CRS-15P、CRS-17P、PA-17、CF-22P	
BM-26	M25xP1.5	25	25+0.3	15.0	BG-25P、BG-26P、CRS-19P、CRS-22P、CF-26P	
BM-34	M32xP1.5	32	32+0.3	15.0	BG-32P、BG-34P、CRS-28P、PA-29、CF-34P	25pcs
BM-42	M40xP1.5	40	40+0.3	15.0	BG-40P、BG-42P、CRS-32P、CRS-35P、PA-36、CF-42P	10pcs
BM-48	M50xP1.5	50	50+0.3	22.4	BG-48P	

# 0616 KSS EASY TYPE FLEXIBLE CONDUIT ADAPTOR



- Material: UL94V-2 flame rated, UL approved Nylon 66.
- Color: Black / Grey
- Feature : One piece design, easy and faster installation without tool.



Item No.		Mounting Hole	Suitable Conduit	Packing
Grey	Black			
BGQ-16	BGQ-16BK	16	BG-16P	50 pcs (with screw nut)
BGQ-18	BGQ-18BK	17	BG-18P	
BGQ-20	BGQ-20BK	20	BG-20P	
BGQ-22	BGQ-22BK	20	BG-22P	
BGQ-25	BGQ-25BK	25	BG-25P	
BGQ-26	BGQ-26BK	24	BG-26P	
BGQ-32	BGQ-32BK	32	BG-32P	25 pcs (with screw nut)
BGQ-34	BGQ-34BK	32.5	BG-34P	

## INSTALL INSTRUCTION



STEP1  
Insert the conduit into the adaptor.



STEP2  
Push lock out.



STEP3  
Turn it around for locking.

# 0616 KSS EASY TYPE FLEXIBLE CONDUIT ADAPTOR



- Material: UL94V-2 flame rated, UL approved Nylon 66.
- Color: Black
- Feature : One piece design, easy and faster installation without tool.



## PG THREAD

UNIT : mm

Item No.	Thread	Thread O.D.	Mounting Hole	Suitable Conduit	Packing
PAQ-0707	PG7	15.2	12.5+0.2	PA-07	50 pcs (with screw nut)
PAQ-0709	PG9	15.2	15.2+0.2	PA-07	
PAQ-1009	PG9	15.2	15.2+0.2	PA-10	
PAQ-1209	PG9	15.2	15.2+0.2	PA-12	
PAQ-1211	PG11	18.6	18.6+0.2	PA-12	
PAQ-12135	PG13.5	20.4	20.4+0.2	PA-12	
PAQ-1216	PG16	22.5	22.5+0.2	PA-12	
PAQ-17135	PG13.5	20.4	20.4+0.2	PA-17	
PAQ-1716	PG16	22.5	22.5+0.2	PA-17	
PAQ-1721	PG21	28.3	28.3+0.3	PA-17	
PAQ-2321	PG21	28.3	28.3+0.3	PA-23	25 pcs (with screw nut)
PAQ-2929	PG29	37.0	37.0+0.3	PA-29	
PAQ-3636	PG36	47.0	47.0+0.3	PA-36	10 pcs (with screw nut)
PAQ-4848	PG48	59.3	59.3+0.3	PA-48	

## INSTALL INSTRUCTION



STEP1  
Insert the conduit into the adaptor.



STEP2  
Push lock out.



STEP3  
Turn it around for locking.



## 0620 KSS FLEXIBLE CONDUIT



- Material: PE(EVA available)
- For running cable protection in Electrical/Machinery/Building Harness wiring.
- Flexible body facilitate your corner/elbow wiring.

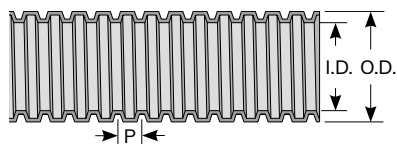

### ● Close design

UNIT : mm

Item No.	I.D.	O.D.	P	Suitable Adaptor	Packing
BG-10P	7.4±0.4	10.2±0.4	2.6±0.3	BG-10	300M
BG-14P	10.7±0.4	14.1±0.4	2.6±0.3	BG-14	100M
BG-16P	10.7±0.4	16.0±0.4	3.2±0.4	BG-16, BGQ-16	
BG-18P	13.8±0.4	17.5±0.4	3.2±0.4	BG-18, BGQ-18	
BG-20P	14.1±0.4	20.0±0.4	3.8±0.4	BG-20, BGQ-20	
BG-22P	17.2±0.4	22.0±0.4	3.2±0.4	BG-22, BGQ-22	
BG-25P	18.3±0.4	25.0±0.4	4.3±0.4	BG-25, BGQ-25	
BG-26P	21.2±0.4	25.8±0.4	3.2±0.4	BG-26, BGQ-26	50M
BG-32P	24.3±0.4	32.0±0.4	5.0±0.5	BG-32, BGQ-32	
BG-34P	28.7±0.4	34.0±0.4	3.2±0.4	BG-34, BGQ-34	
BG-40P	31.2±0.4	40.0±0.4	5.8±0.5	BG-40	
BG-42P	34.9±0.4	42.0±0.4	3.2±0.4	BG-42	
BG-48P	40.0±0.5	48.0±0.5	4.6±0.4	BG-48	
BG-50P	39.6±0.5	50.0±0.5	7.4±0.6	BG-50	30M
BG-55P	47.5±0.4	54.5±0.5	3.2±0.4		
BG-60P	52.0±0.5	60.0±0.5	6.2±0.5		
BG-76P	62.0±0.5	76.0±0.5	6.2±0.5		

## 0620 KSS NYLON FLEXIBLE CONDUIT



- Material: UL94HB flame rated Nylon 6.
- Color: Black
- For running cable protection in Electrical/Machinery/Building Harness wiring.
- Flexible body facilitate your corner/elbow wiring.

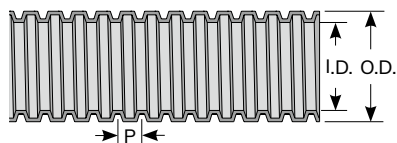

UNIT : mm

Item No.		Trade Size	I.D.	O.D.	P	Suitable Adaptor	Packing
Close design	Split design	Inch					
PA-07	PAO-07	1/4"	6.0±0.25	9.8±0.35	3.3±0.4	PAQ-0707, PAQ-0709	50M
PA-10	PAO-10	5/16"	9.0±0.25	13.0±0.35	3.0±0.4	PAQ-1009	
PA-12	PAO-12	3/8"	11.4±0.35	15.5±0.35	3.0±0.4	PAQ-1209, PAQ-1211, PAQ-12135, PAQ-1216	
PA-17	PAO-17	1/2"	16.3±0.35	21.6±0.45	3.3±0.4	PAQ-17135, PAQ-1716, PAQ-1721	
PA-23	PAO-23	3/4"	22.4±0.45	28.2±0.45	3.6±0.4	PAQ-2321	
PA-29	PAO-29	1"	27.9±0.45	34.0±0.45	3.6±0.4	PAQ-2929	
PA-36	PAO-36	1 1/4"	35.8±0.45	42.4±0.6	3.3±0.4	PAQ-3636	25M
PA-48	PAO-48	2"	47.5±0.6	54.5±0.6	3.0±0.4	PAQ-4848	

# 0620 KSS FLEXIBLE CONDUIT

- Material : PP
- Color: Black
- Function: For running cable protection in Electrical/Machinery/ Building Harness wiring.
- For split design PP flexible conduit, can use the KSS Split Wrapping Band Installation tool (see P.98) to wrap the wire easily.
- ※ It may be harder while inserting split design conduit to claw.

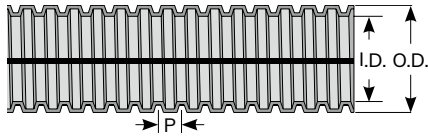

UNIT : mm

Item No.		I.D.	O.D.	P	Suitable Adaptor ※	Packing
Close design	Split design					
CR-05P	CRS-05P	5.6±0.4	7.9±0.4	2.6±0.3		300M
CR-07P	CRS-07P	7.4±0.4	10.2±0.4	2.6±0.3	PAQ-0707/PAQ-0709	
CR-11SP	CRS-11SP	10.7±0.4	14.0±0.4	2.6±0.3		
CR-11P	CRS-11P	10.7±0.4	16.0±0.4	3.3±0.4	PAQ-1216 / PAQ-1211 / PAQ-1209 / PAQ-12135 / BG-16 / BGQ-16	200M
CR-13P	CRS-13P	13.8±0.4	17.5±0.4	3.0±0.4	BG-18 / BGQ-18	
CR-15P	CRS-15P	15.0±0.4	19.5±0.4	3.3±0.4	BGQ-20	100M
CR-17P	CRS-17P	17.2±0.4	22.0±0.4	3.0±0.4	PAQ-17135 / PAQ-1721 / BG-22 / BGQ-22	
CR-19P	CRS-19P	19.3±0.4	23.8±0.4	3.3±0.4	BG-26 / BGQ-25	
CR-22P	CRS-22P	21.2±0.4	25.8±0.4	3.0±0.4	BG-26 / BGQ-26	50M
CR-24P	CRS-24P	24.3±0.4	32.0±0.4	4.6±0.4	BG-32 / BGQ-32	
CR-25P	CRS-25P	25.0±0.4	30.0±0.4	4.0±0.4	BG-32	
CR-28P	CRS-28P	28.0±0.4	34.0±0.4	3.0±0.4	BG-34 / BGQ-34	
CR-32P	CRS-32P	31.2±0.4	40.0±0.4	5.8±0.5	BG-40	
CR-35P	CRS-35P	34.9±0.4	42.0±0.4	3.3±0.4		
CR-40P	CRS-40P	39.6±0.5	50.0±0.5	6.7±0.5	BG-48 / BG-50	
CR-48P	CRS-48P	47.5±0.5	54.5±0.5	3.3±0.4	PAQ-4848	

# 0621 KSS PVC FLEXIBLE CONDUIT



- Material: UL94V-0 flame rated PVC, Nylon for Rope.
- Color: Orange
- Feature: 1. Compliant with RoHS.  
2. Pre-inserted Nylon rope makes cable installation easier.  
3. Great substitute for PVC pipe.
- Application: Ideal use in indoor wirings such as optical fiber and telecommunication cable, vertical runs between floors, etc (except the plenum) .
- Usage: Cut the conduit into required length and fix cables on the pre-inserted Nylon rope in one side, then pull out the rope from the other side to finish the installation.
- ※ Split design and special colors are available on request



Wiring Ducts

Cable Markers

Cable Ties

Wrapping Bands

Cable Clamps & Tie Mounts

Glands, Bushings

Conduits

Bushings

Wire Connectors

Tubes

Cable Clips

PCB Parts

Fasteners

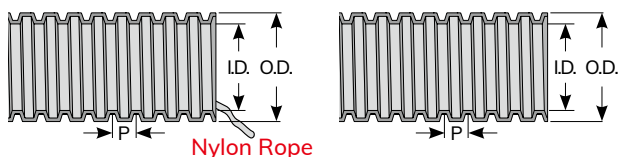

UNIT : mm

Item No.		Trade Size	I.D.	O.D.	P	Packing
Close Design With Nylon Rope	Close Design	Inch				
CPW-26POE	CP-26POE	1"	25.9	34.0	6.6±0.5	30.5M (100 FT)
CPW-34POE	CP-34POE	1 1/4"	34.1	42.6	6.6±0.5	
CPW-40POE	CP-40POE	1 1/2"	39.5	48.3	6.6±0.5	
CPW-51POE	CP-51POE	2"	50.8	60.5	6.6±0.5	15.3M (50 FT)

# 0621 KSS CONVEY FLEXIBLE CONDUIT



- Material: PE
- Color: Black
- Used to protect wiring inside the wall to replace normal PVC pipe. Flexible design for better wire running.

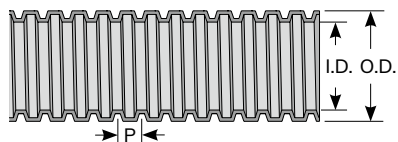

UNIT : mm

● Close design

Item No.	I.D.	O.D.	P	Suitable Adaptor	Packing
CF-14P	10.7±0.4	14.1±0.4	2.6±0.3	BG-14	100M
CF-18P	13.8±0.4	17.5±0.4	3.0±0.4	BG-18	
CF-22P	17.2±0.4	22.2±0.4	3.0±0.4	BG-22	
CF-26P	21.2±0.4	25.8±0.4	3.0±0.4	BG-26	
CF-34P	28.7±0.4	34.0±0.4	3.0±0.4	BG-34	
CF-42P	34.9±0.4	42.0±0.4	3.0±0.4		50M

# 0617 KSS METAL FLEXIBLE CONDUIT ADAPTOR

- Material: ABS
- Color: Grey
- Conduit adaptor designed for metal conduit.



UNIT : mm

Item No.	Thread O.D.	Mounting Hole	L1	Suitable Conduit	Packing
MG-18	20.6	20.6+0.2	17.0	MCR04 (3/8")	50pcs
MG-22	20.6	20.6+0.2	17.0	MCR05 (1/2")	
MG-26	25.0	25.0+0.3	15.8	MCR06 (3/4")	
MG-32	32.6	32.6+0.3	21.7	MCR08 (1")	25pcs
MG-41	41.5	41.5+0.3	18.0	MCR10 (1 1/4")	

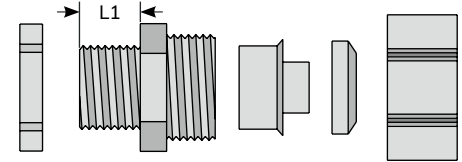

Part No.: Lock Nut MGL, Body MGB, Claw MGC, Seal MGS, Nut MGN

Wiring Ducts  
Cable Markers  
Cable Ties  
Wrapping Bands  
Cable Clamps & Tie Mounts  
Glands, Bushings  
Conduits  
Wire Connectors  
Tubes  
Cable Clips  
PCB Parts  
Fasteners

# 0625 KSS METAL FLEXIBLE CONDUIT

- Material : Steel with PVC coating.
- Waterproof, high tensile strength. Good resistance in bending, erosion.



UNIT : mm

Item No.	Trade Size	I.D.	O.D.	Packing
	inch			
MCR-02	1/4"	8.0	11.3	100M
MCR-03	5/16"	10.0	13.6	
MCR-04	3/8"	12.6	16.2	
MCR-05	1/2"	16.0	20.0	50M
MCR-06	3/4"	21.0	24.4	
MCR-08	1"	26.3	30.6	
MCR-10	1 1/4"	35.0	40.6	30M
MCR-12	1 1/2"	40.3	46.0	25M
MCR-16	2"	51.6	58.4	20M
MCR-20	2 1/2"	64.5	71.6	10M
MCR-24	3"	78.3	86.4	
MCR-32	4"	99.6	113.3	

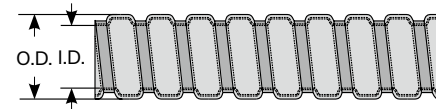

# 0625 KSS METAL FLEXIBLE CONDUIT ADAPTOR

- Material: Zinc Alloy
- Feature: Waterproof, Corrosion resistance, Heat resistance.
- To Apply, putting NUT and SEAL on the end of metal flexible conduit, then screw CLAW of the metal adaptor into metal flexible conduit till tight.

## Control box adaptor

UNIT : mm

Item No.	Thread	Thread O.D.	Mounting Hole	L1	Suitable for metal flexible conduit	Packing
NBG-02	PT 1/4"	13.6	13.6+0.2	8.0	MCR-02 (1/4")	50pcs
NBG-03	PT 5/16"	15.5	15.5+0.2	8.3	MCR-03 (5/16")	
NBG-04	PT 1/2"	20.2	20.2+0.2	10.0	MCR-04 (3/8")	
NBG-05	PT 1/2"	20.2	20.2+0.2	12.3	MCR-05 (1/2")	
NBG-06	PT 3/4"	25.9	25.9+0.3	13.7	MCR-06 (3/4")	
NBG-08	PT 1"	32.3	32.3+0.3	14.7	MCR-08 (1")	
NBG-10	PT 1 1/4"	41.0	41.0+0.3	17.1	MCR-10 (1 1/4")	20pcs
NBG-12	PT 1 1/2"	47.1	47.1+0.3	19.4	MCR-12 (1 1/2")	10pcs
NBG-16	PT 2"	58.4	58.4+0.3	20.7	MCR-16 (2")	5pcs
NBG-20	PT 2 1/2"	74.1	74.1+0.4	24.2	MCR-20 (2 1/2")	1pcs
NBG-24	PT 3"	86.7	86.7+0.4	25.5	MCR-24 (3")	
NBG-32	PT 4"	112.0	112.0+0.5	30.8	MCR-32 (4")	



NBG

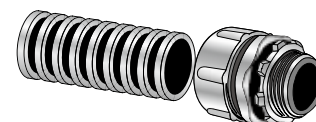
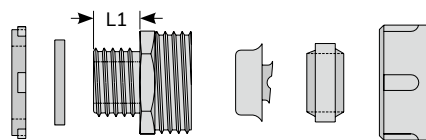

(Metal flexible conduit) NBG (control box adaptor)



FBG

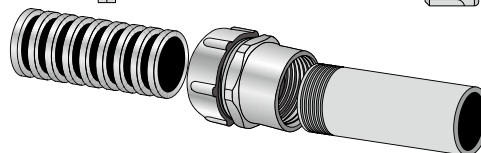
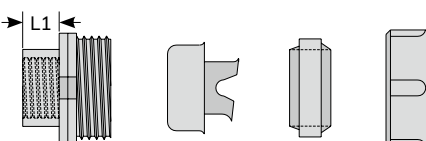

(Metal flexible conduit) FBG (PT thread for metal pipe)

## Inner thread type adaptor

UNIT : mm

Item No.	Thread	Thread I.D.	L1	Suitable for metal flexible conduit	Packing
FBG-04	PT 1/2"	19.2	12.2	MCR-04 (3/8")	50pcs
FBG-05	PT 1/2"	19.2	13.9	MCR-05 (1/2")	
FBG-06	PT 3/4"	25.0	13.9	MCR-06 (3/4")	
FBG-08	PT 1"	31.3	15.0	MCR-08 (1")	30pcs
FBG-10	PT 1 1/4"	40.2	21.1	MCR-10 (1 1/4")	20pcs
FBG-12	PT 1 1/2"	45.8	19.9	MCR-12 (1 1/2")	10pcs
FBG-16	PT 2"	57.3	23.3	MCR-16 (2")	5pcs
FBG-20	PT 2 1/2"	73.3	24.5	MCR-20 (2 1/2")	1pcs
FBG-24	PT 3"	85.8	27.7	MCR-24 (3")	
FBG-32	PT 4"	110.8	25.5	MCR-32 (4")	

## L type adaptor for control box

UNIT : mm

Item No.	Thread	Thread O.D.	Mounting Hole	L1	Suitable for metal flexible conduit	Packing
RBG-04	PT 1/2"	20.2	20.2+0.2	12.5	MCR-04 (3/8")	50pcs
RBG-05	PT 1/2"	20.2	20.2+0.2	13.6	MCR-05 (1/2")	
RBG-06	PT 3/4"	25.9	25.9+0.3	15.0	MCR-06 (3/4")	
RBG-08	PT 1"	32.3	32.3+0.3	15.7	MCR-08 (1")	30pcs
RBG-10	PT 1 1/4"	41.0	41.0+0.3	16.8	MCR-10 (1 1/4")	20pcs
RBG-12	PT 1 1/2"	47.1	47.1+0.3	17.8	MCR-12 (1 1/2")	10pcs
RBG-16	PT 2"	58.4	58.4+0.3	20.1	MCR-16 (2")	5pcs
RBG-20	PT 2 1/2"	74.1	74.1+0.4	26.0	MCR-20 (2 1/2")	1pcs
RBG-24	PT 3"	86.7	86.7+0.4	26.2	MCR-24 (3")	
RBG-32	PT 4"	112.0	112.0+0.5	29.1	MCR-32 (4")	



RBG

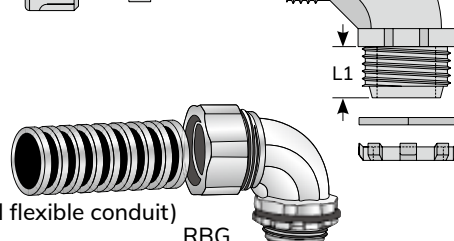
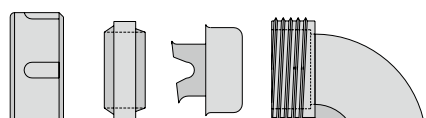

(Metal flexible conduit) RBG (control box adaptor)

# 0625 KSS METAL FLEXIBLE CONDUIT ADAPTOR

- Material: Zinc Alloy
- Feature: Waterproof, Corrosion resistance, Heat resistance.
- To Apply, putting NUT and SEAL on the end of metal flexible conduit, then screw CLAW of the metal adaptor into metal flexible conduit till tight.

## EMT pipe adaptor

UNIT : mm

Item No.	EMT Pipe	I.D.	L1	suitable for metal flexible conduit	Packing
EBG-04	E19(1/2")	19.6	12.5	MCR-04 (3/8")	50pcs
EBG-05	E19(1/2")	19.6	12.2	MCR-05 (1/2")	
EBG-06	E25(3/4")	26.2	13.6	MCR-06 (3/4")	
EBG-08	E31(1")	32.1	15.4	MCR-08 (1")	30pcs
EBG-10	E39(1 1/4")	38.6	19.7	MCR-10 (1 1/4")	20pcs
EBG-12	E51(1 1/2")	51.9	19.5	MCR-12 (1 1/2")	10pcs
EBG-16	E63(2")	64.4	25.8	MCR-16 (2")	5pcs
EBG-20	E75(2 1/2")	76.7	27.7	MCR-20 (2 1/2")	1pcs
EBG-24	E82(3")	89.8	29.6	MCR-24 (3")	
EBG-32	E104(4")	115.8	36.3	MCR-32 (4")	



EBG

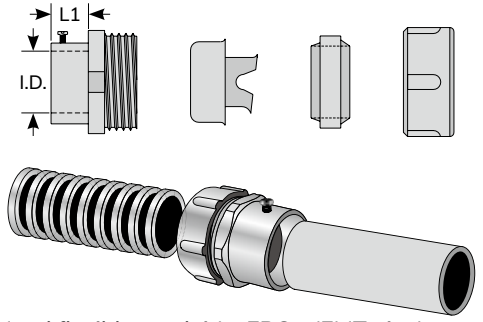

(Metal flexible conduit) EBG (EMT pipe)

## PVC pipe adaptor

UNIT : mm

Item No.	PVC Pipe	I.D.	L1	suitable for metal flexible conduit	Packing
PBG-05	#16(1/2")	22.3	14.6	MCR-05 (1/2")	50pcs
PBG-06	#20(3/4")	27.0	14.5	MCR-06 (3/4")	
PBG-08	#28(1")	34.0	15.2	MCR-08 (1")	
PBG-10	#35(1 1/4")	43.7	16.9	MCR-10 (1 1/4")	20pcs
PBG-12	#41(1 1/2")	51.9	19.5	MCR-12 (1 1/2")	10pcs
PBG-16	#52(2")	64.4	25.8	MCR-16 (2")	5pcs
PBG-20	#65(2 1/2")	76.7	27.7	MCR-20 (2 1/2")	1pcs
PBG-24	#80(3")	89.8	29.6	MCR-24 (3")	
PBG-32	#100(4")	115.8	36.3	MCR-32 (4")	



PBG

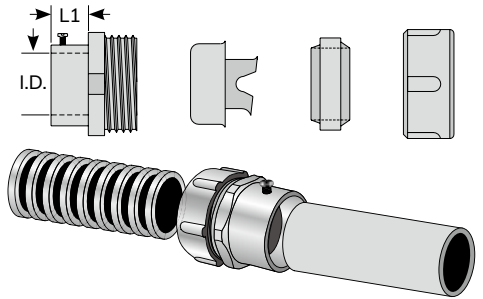

(Metal flexible conduit) PBG (PVC pipe)

# 0625 KSS METAL FLEXIBLE CONDUIT END CAP



- Material: Zinc Alloy
- Function: Protect the end of metal flexible conduit.

UNIT : mm

Item No.	suitable for metal flexible conduit	Packing
NBGC-02	MCR-02 (1/4")	50pcs
NBGC-03	MCR-03 (5/16")	
NBGC-04	MCR-04 (3/8")	
NBGC-05	MCR-05 (1/2")	
NBGC-06	MCR-06 (3/4")	
NBGC-08	MCR-08 (1")	30pcs
NBGC-10	MCR-10 (1 1/4")	20pcs
NBGC-12	MCR-12 (1 1/2")	10pcs
NBGC-16	MCR-16 (2")	5pcs
NBGC-20	MCR-20 (2 1/2")	1pcs
NBGC-24	MCR-24 (3")	
NBGC-32	MCR-32 (4")	



# Bushings

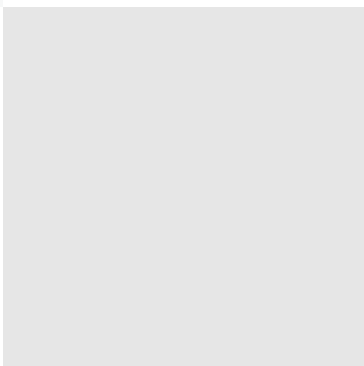
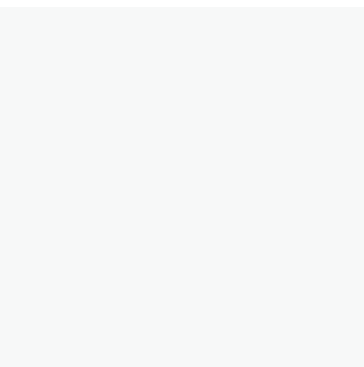

Wiring  
Ducts

Cable  
Markers

Cable  
Ties

Wrapping  
Bands

Cable Clamps  
& Tie Mounts

Glands,  
Bushings

Conduits

**Bushings**

Wire  
Connectors

Tubes

Cable  
Clips

PCB  
Parts

Fasteners

# 0701 KSS MOVABLE BUSHING

- Material: PE, NYLON. Nylon product has more flexibility and better adhesion.
- Color: Natural.
- Usage: Cut to fit any hole sizes for cords, wires, cables protection against damage from sharp panel edges.
- Function: Wires and cables protection and insulation.
- Advantage:
  1. Flexible, high adhesion, smooth surface.
  2. KGH series packed with paper spool for easy storage, and could be used for longer time.



## ◆ PE

UNIT : mm

Item No.	W1	Chassis Thickness	Packing
KG-008	0.8	under 0.8	10 M/bag
KG-010	1.0	0.8~1.0	
KG-012	1.2	1.0~1.2	
KG-016	1.6	1.2~1.6	
KG-020	2.0	1.6~2.0	
KG-024	2.4	2.0~2.4	
KG-032	3.2	2.4~3.2	
KG-045	4.5	3.2~4.5	100M/RL
KGH-008	0.8	under 0.8	
KGH-010	1.0	0.8~1.0	
KGH-012	1.2	1.0~1.2	
KGH-016	1.6	1.2~1.6	
KGH-020	2.0	1.6~2.0	
KGH-024	2.4	2.0~2.4	
KGH-032	3.2	2.4~3.2	
KGH-045	4.5	3.2~4.5	

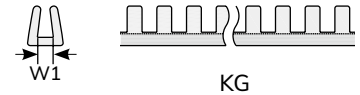

## ◆ PE STRAIGHT CUTTING

Item No.	W1	Chassis Thickness	Packing
KGC-012	1.2	1.0~1.2	10M
KGC-016	1.6	1.2~1.6	
KGC-020	2.0	1.6~2.0	
KGC-024	2.4	2.0~2.4	
KGC-032	3.2	2.4~3.2	
KGC-045	4.5	3.2~4.5	

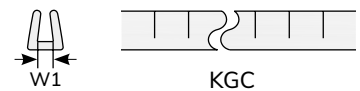

KGK STRAIGHT CUTTING

## ◆ NYLON 66

Item No.	W1	Chassis Thickness	Packing
KG-010N	1.0	under 1.0	25 cm/pc 100 pcs/bag
KG-014N	1.4	1.0~1.4	
KG-016N	1.6	1.2~1.6	
KG-020N	2.0	1.6~2.0	
KG-024N	2.4	2.0~2.4	
KG-032N	3.2	2.4~3.2	
KG-045N	4.5	3.2~4.5	

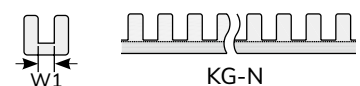

KG-N



# 0703 KSS EDGING GROMMET

- Material: PE
- Color: Natural.
- Cut length optionally to fit your chassis edging protection or other application for smoothing edges.
- Protect wires, cables and chassis insulation.

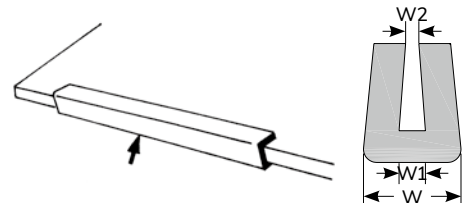

UNIT : mm

Item No.	W	W1	W2	Chassis Thickness	Packing
ED-010	3.3	1.0	0.5	under 1.0	10M
ED-012	3.4	1.2	0.6	1.0~1.2	
ED-016	4.6	1.6	0.9	1.2~1.6	
ED-020	4.5	2.0	1.1	1.6~2.0	
ED-024	5.1	2.4	1.2	2.0~2.4	
ED-032	5.8	3.2	1.5	2.4~3.2	
ED-055	7.9	5.5	4.5	4.5~5.5	

Wiring Ducts

Cable Markers

Cable Ties

Wrapping Bands

# 0705 KSS STRAIN RELIEF BUSHING

- Material: UL94V-2 flame rated, UL approved Nylon 66.
  - Color: Black
  - Cuts assembly cost, prolongs cords life. Used extensively for protecting cords of computer, apparatus, etc.
- ※Application Tool: KT-1



CORD ASSEMBLY

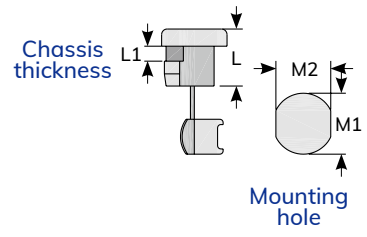
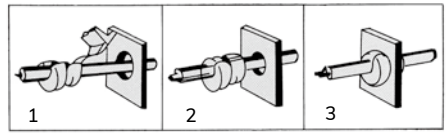

UNIT : mm

Item No.	Cross Section Shape	Wires Accommodate		Mounting Hole		Part L L	Chassis Thickness L1	Packing
		UL Wire	Size	M1	M2			
SR-F21	Flat	SPT-1 2C #18	2.3X4.5 / 2.8X5.3	9.5	8.7	10.3	0.5-1.6	100pcs
SR-F23		SPT-1 2C #18	2.3X4.5 / 2.8X5.3	9.5	8.7	10.3	1.8-3.2	
SR-F31		SPT-1 2C #18	3.0X5.6	11.2	9.9	10.3	1.0-1.6	
SR-F32		SPT-1 2C #18	3.0X5.6	11.0	9.9	10.3	1.9-2.5	
SR-F41		SPT-2 2C #18	3.0X7.1 / 3.8X7.6	12.7	11.8	10.3	0.5-1.6	
SR-F42		SPT-2 2C #18	3.0X7.1 / 3.8X7.6	12.7	11.8	10.3	1.8-2.5	
SR-F51		SPT-3 2C #18	5X10.4	14.3	12.9	15.2	0.5-1.6	
SR-F53		SPT-3 2C #18	5X10.4	14.3	12.9	15.2	1.8-3.5	
SR-F83			6X15.2	21.6	21.3	20.4	2.0-3.4	
SR-5R1		Round	SVT 3C #18	Ø6.2~Ø7.4	12.8	11.5	11.0	
SR-5R2	SVT 3C #18		Ø6.2~Ø7.4	13.0	11.5	11.0	1.8-2.5	
SR-6W2	SJT 3C #18		Ø7.6	12.8	11.8	11.0	1.8-2.3	
SR-6P1	SJT 3C #18		Ø7.4~Ø8.2	15.9	14.0	14.8	0.5-1.6	
SR-6P3	SJT 3C #18		Ø7.4~Ø8.2	15.9	14.0	14.8	1.9-3.2	
SR-6R1	SJT 3C #16		Ø8.2~Ø9.2	15.9	14.0	14.8	0.5-1.6	
SR-6R3	SJT 3C #16		Ø8.2~Ø9.2	15.9	14.0	14.8	1.9-3.2	
SR-7R1	SJT 3C #14		Ø9.2~Ø10.5 / Ø11	19.9	17.0	19.0	0.5-1.6	
SR-7R3	SJT 3C #14		Ø9.2~Ø10.5 / Ø11	19.7	17.0	19.0	1.9-3.2	
SR-8R3	SJT 3C #14		Ø12~Ø15.2	21.6	21.3	20.6	1.9-3.2	
SR-9R1	#18 20~30 pcs	Ø11~Ø15	15.0	19.0	17.5	0.5-1.6		
SR-9R7	SJT 3C #10	Ø15.2~Ø16.3 / Ø17.5	28.0/30.2	25.5	25.2	1.0-3.2		

Cable Clamps & Tie Mounts

Glands, Bushings

Conduits

Bushings

Wire Connectors

Tubes

Cable Clips

PCB Parts

Fasteners

## 0705A KSS STRAIN RELIEF BUSHING ASSEMBLY TOOL

- Item No. : KT-1 (Stainless)
- Material: 304SS with PVC tube.



## 0707 KSS SQUARE STRAIN RELIEF BUSHING



- Material: UL94V-2 flame rated, UL approved Nylon 66.
  - Cuts assembly cost, prolongs cords life. Used extensively for protecting cords of computer, apparatus, etc.
- ※Application Tool: KT-1

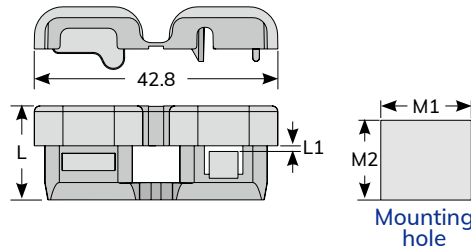

UNIT : mm

Item No.	Wires Accommodate		Mounting Hole		Part Length L	Chassis Thickness L1	Packing
	UL Wire	Size	M1	M2			
SR-S41	SPT-1	3.0X5.6	16	11.5	16.5	1.0~1.2	100pcs
	SPT-2	3.8X7.6					

## 0708 KSS FLEXIBLE RIGHT ANGLE STRAIN RELIEF BUSHING



- Material: UL94V-2 flame rated, UL approved Nylon 66.
  - Color: Black
  - Protect power cable from computer, house appliance or electronic/ electrical equipment when power cable run out from bottom of equipment.
  - Strain relief design protect power cord from breakage.
  - Assemble according to photos below.
- ※Application Tool: KT-1



CORD ASSEMBLY

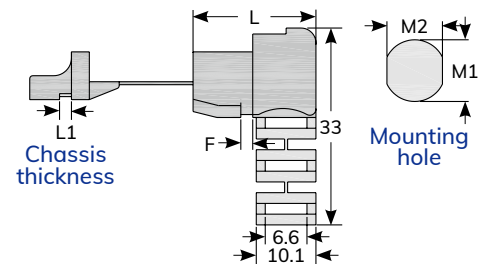
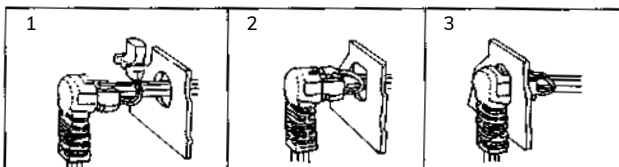

UNIT : mm

Item No.	Cross Section Shape	Wires Accommodate		Mounting Hole		Part Length L	Chassis Thickness L1	Packing
		UL Wire	Size	M1	M2			
SR-F42LF	Flat	SPT-2	3.3 X 6.6	12.7 ~ 13.2	10.9	20.5	1.5~2.0	100pcs
			3.6 X 7.2	13.2 ~ 13.7				

# 0708 KSS FLEXIBLE STRAIN RELIEF BUSHING



- Material: UL94V-2 flame rated, UL approved Nylon 66.
- Color: Black
- ※Application Tool: KT-1

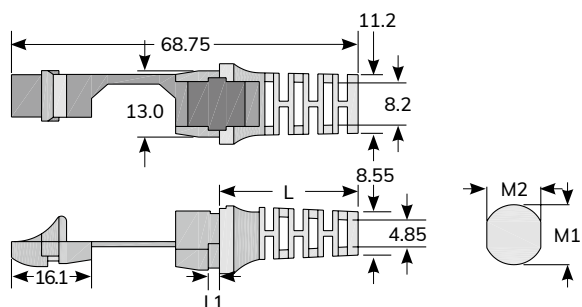

UNIT : mm

Item No.	Cross Section Shape	Wires Accomodate		Mounting Hole		Part Length L	Chassis Thickness L1	Packing
		UL Wire	Size	A	B			
SR-F52F	Flat	SPT-2	4.6X8	12.7~13.2	13	27.55	0.8~2.3	100pcs

# 0709 KSS RIGHT ANGLE STRAIN RELIEF BUSHING



- Material: UL94V-2 flame rated, UL approved Nylon 66.
- Color: Black
- Protect power cable from chassis.
- L type design facilitate power cord runs out.
- Assemble according photos as below.
- ※Application Tool: KT-1



CORD ASSEMBLY

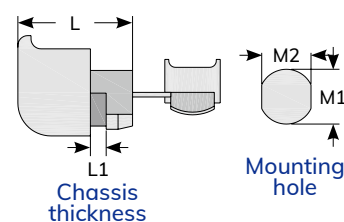
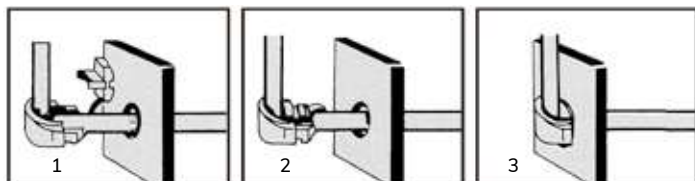

UNIT : mm

Item No.	Cross Section Shape	Wires Accomodate		Mounting Hole		Part Length L	Chassis Thickness L1	Packing
		UL Wire	Size	M1	M2			
SR-F42L	Flat	SPT-1 SPT-2	3 X 5.6 3.8 X 7.1	12.7	11.8	17.7	1.8~2.6	100pcs

# 0710 KSS SNAP BUSHING

- Material: UL94V-2 flame rated, UL approved Nylon 66.
- Color: Black
- KSS SNAP BUSHING smooth and insulate your raw-edged holes in metal chassis.
- Locking into hole firmly with fingertip pressure.
- Protect electrical cables, ropes, utility lines through metal holes.
- Available in application for chassis thickness under 3.2mm



UNIT : mm

Item No.	Mounting Hole		Chassis Thickness	I.D.	O.D.	H	H1	Packing
	mm	inch						
SB-7S	7.1	9/32"	1.8	5.8	8.8	6.1	1.3	100pcs
SB-8S	7.9	5/16"	1.8	6.8	9.8	6.0	1.5	
SB-12S	11.9	15/32"	1.8	9.2	13.7	6.3	1.5	
SB-22S	22.2	7/8"	1.8	19.6	24.0	6.5	1.5	
SB-8	7.9		1.6	5.8	10.5	8.0	1.6	100pcs
SB-8A	7.9		2.2	5.1	10.3	8.0	1.6	
SBP-8	7.4			5.9	10.8	15.0	2.0	
SB-10	9.5	3/8"	3.2	6.4	12.0	10.3	1.6	
SB-10M	9.5	3/8"	3.2	7.8	13.0	10.5	1.6	
SB-13	12.7	1/2"	3.2	8.0	15.0	10.3	1.6	
SB-14	14.3	9/16"	3.2	11.4	17.0	10.3	1.5	
SB-16	15.9	5/8"	3.2	12.7	18.6	10.3	1.6	
SB-19	19.1	3/4"	3.2	14.3	21.7	10.3	1.6	
SB-19M	19.1	3/4"	3.2	15.8	21.7	10.3	1.6	
SB-20	20.0		3.2	15.9	22.4	10.0	1.4	
SB-22	22.2	7/8"	3.2	17.5	24.2	11.5	1.6	
SB-22M	22.2	7/8"	3.2	18.9	24.2	11.5	1.6	
SB-25	25.4	1"	3.5	19.5	28.5	11.7	1.8	
SB-26	25.4		3.2	19.1	28.5	11.5	1.6	
SB-30	30.1	1 3/16"	3.2	24.1	33.3	11.5	1.6	
SB-32	32.0		3.5	23.8	34.6	11.4	1.5	
SB-38	38.1	1 1/2"	3.2	29.0	42.1	11.4	1.5	
SB-45	44.5	1 3/4"	3.2	35.4	47.8	11.6	1.5	
SB-50	50.8	2"	3.2	41.6	54.6	11.8	1.6	

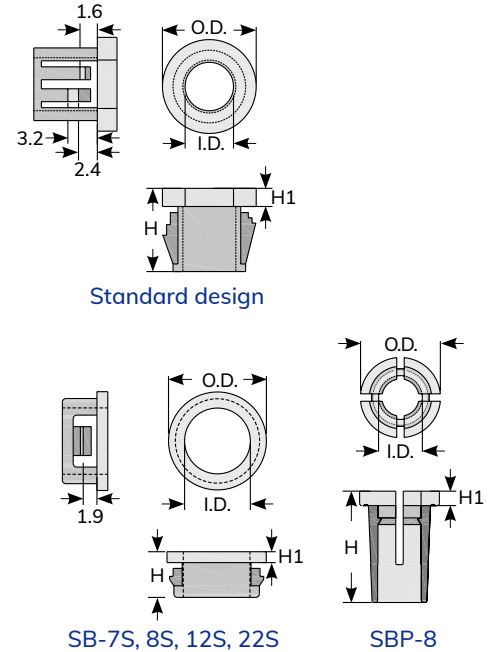

# 0712 KSS SNAP BUSHING

- Material: UL94V-2 flame rated, UL approved Nylon 66.
- Color: Black
- Universal design to hold various cable range with a fix size.



UNIT : mm

Item No.	Mounting Hole		Chassis Thickness	I.D.	O.D.	H	Packing
	mm	inch					
RSB-16	15.9	5/8"	3.2	12.7	20.5	10.3	100pcs
RSB-19	19.1	3/4"	3.2	14.8	24.0	10.0	
RSB-21	20.6	13/16"	3.2	15.2	24.3	10.0	
RSB-22	22.2	7/8"	3.2	17.0	25.4	11.5	
RSB-25S	25.4	1"	3.2	21.0	27.0	11.4	
RSB-25	25.4	1"	3.2	20.4	28.5	11.5	
RSB-28	27.6	1 3/32"	3.2	23.0	31.2	11.5	
RSB-35	34.9	1 3/8"	3.2	29.5	38.5	11.7	
RSB-38	38.1	1 1/2"	3.2	31.0	41.0	11.0	

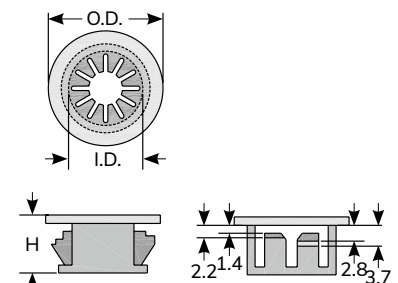

# 0713 KSS SNAP BUSHING (OPEN)

- Material: UL94V-2 flame rated, UL approved Nylon 66.
- Color: Black
- Protect power cord and smooth chasis hole.
- Finger-tip pressure to install. No tool is needed.
- Can be applied after power cable installed.

UNIT : mm

Item No.	Mounting Hole		Chassis Thickness	I.D.	O.D.	H	Packing
	mm	inch					
OSB-9S	9.5	3/8"	1.6	6.5	11.3	6.1	100pcs
OSB-12S	12.7	1/2"	1.6	9.6	15.8	7.3	
OSB-10	9.5	3/8"	3.5	6.0	11.8	9.8	
OSB-13	12.7	1/2"	3.2	7.5	15.1	10.3	
OSB-16	15.9	5/8"	3.2	11.2	18.5	10.3	
OSB-19	19.1	3/4"	3.2	12.5	21.0	10.3	
OSB-22	22.2	7/8"	3.2	17.0	24.6	10.3	
OSB-26	25.4	1"	3.2	20.0	28.0	10.6	

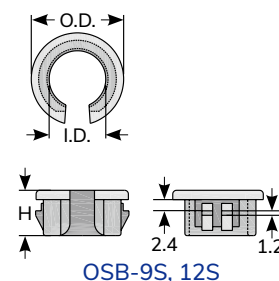
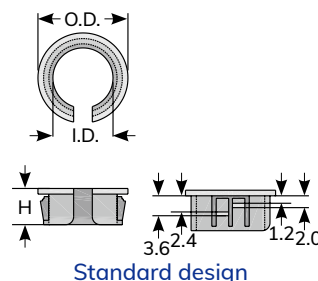

# 0715 KSS HOLE PLUG

- Material: UL94V-2 flame rated, UL approved Nylon 66.
- Color: Black
- KSS HOLE PLUG close your unneeded holes with fingertip pressure at low cost and assure good appearance.

UNIT : mm

Item No.	Mounting Hole		Chassis Thickness	O.D.	H	Packing
	mm	inch				
HP-5	5.0		1.8	6.3	5.9	100pcs
HP-6	6.0		2.5	7.8	7.8	
HP-8	7.9	5/16"	1.6	10.3	8.1	
HP-10	9.5	3/8"	3.2	13.0	10.5	
HP-13S	12.7	1/2"	3.2	14.5	10.1	
HP-13	12.7	1/2"	3.2	16.5	10.9	
HP-15	14.3	9/16"	3.2	16.7	10.3	
HP-16	15.9	5/8"	3.2	19.5	10.0	
HP-19	19.1	3/4"	3.2	22.9	10.0	
HP-22	22.2	7/8"	3.2	25.8	11.3	
HP-23	23.4		3.2	27.0	11.4	
HP-25	25.4	1"	3.2	29.0	11.6	
HP-30	30.1	1 3/16"	3.2	34.5	12.0	
HP-35	34.9	1 3/8"	3.2	38.1	14.3	
HP-38	38.1	1 1/2"	3.2	42.1	11.2	
HP-45	44.5	1 3/4"	3.2	49.7	11.8	
<b>NEW</b> HP-45L	45.5		3.2	49.7	11.8	

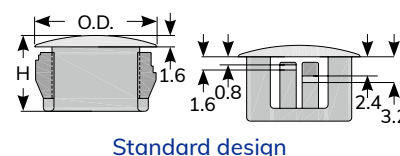
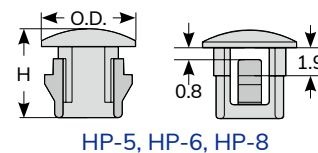

## 0716 KSS SCREW PLUG

- Material: UL94V-2 flame rated, UL approved Nylon 66.
- Color : Black (Grey available)
- KSS SCREW PLUG close your unneeded holes at low cost and assure good appearance.

### METRIC THREAD

UNIT : mm

Item No.	External thread	Thread O.D.	Mounting Hole	O.D.	H	H1	Packing
MSP-12	M12x1.5	12	12.0+0.2	15.0	10.0	6.0	100pcs
MSP-16	M16x1.5	16	16.0+0.2	20.0	10.5	6.0	
MSP-20	M20x1.5	20	20.0+0.2	24.0	10.5	6.0	
MSP-25	M25x1.5	25	25.0+0.3	29.7	12.8	7.8	50pcs
MSP-32	M32x1.5	32	32.0+0.3	36.6	13.3	7.8	
MSP-40	M40x1.5	40	40.0+0.3	45.8	13.4	7.8	10pcs
MSP-50	M50x1.5	50	50.0+0.3	55.5	16.2	9.8	
MSP-63	M63x1.5	63	63.0+0.3	69.3	17.5	11.8	

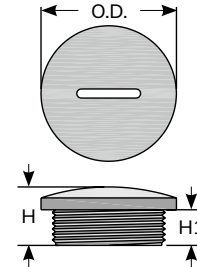

## 0717 KSS SCREW PLUG

- Material: UL94V-2 flame rated, UL approved Nylon 66.
- Color : Black (Grey available)
- KSS SCREW PLUG close your unneeded holes at low cost and assure good appearance.

### PG THREAD

UNIT : mm

Item No.	External thread	Thread O.D.	Mounting Hole	O.D.	H	H1	Packing
PSP-7	PG-7	12.5	12.5+0.2	14.8	10.0	6.0	100pcs
PSP-9	PG-9	15.2	15.2+0.2	18.7	10.4	6.0	
PSP-11	PG-11	18.6	18.6+0.2	21.7	10.4	6.0	
PSP-13.5	PG-13.5	20.4	20.4+0.2	23.7	10.3	6.0	50pcs
PSP-16	PG-16	22.5	22.5+0.2	27.0	10.3	6.0	
PSP-21	PG-21	28.3	28.3+0.3	32.8	12.8	7.8	10pcs
PSP-29	PG-29	37.0	37.0+0.3	44.1	13.3	7.8	
PSP-36	PG-36	47.0	47.0+0.3	52.6	13.7	7.7	
PSP-42	PG-42	54.0	54.0+0.3	59.5	16.3	9.6	10pcs
PSP-48	PG-48	59.3	59.3+0.3	64.2	18.0	11.8	

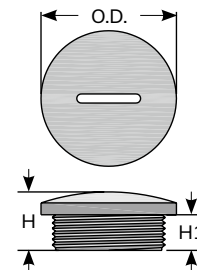

## 0721 KSS EASY FIT GROMMET (OPEN / CLOSED)

- Material : Flexible PVC.
- Color: Black
- ※ GEQ, GECQ is softer.

UNIT : mm

Item No.		Mounting Hole	Chassis Thickness	O.D.	I.D.	H	H1	Packing
Open	Close							
GE-2015	GEC-2015	19.8	1.8	23.9	15.5	8.0	2.1	100pcs
GEQ-2015	GECQ-2015	19.8	1.8	23.9	15.5	8.0	2.1	
GEQ-2621	GECQ-2621	26.2	2.2	30.0	20.8	8.6	2.4	

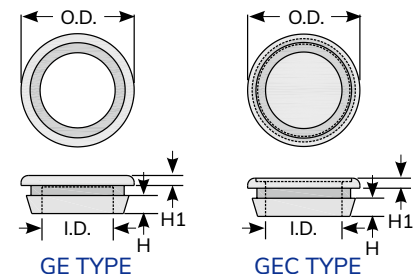

GE TYPE

GEC TYPE

# 0720 KSS GROMMET (OPEN / CLOSED)

- Material : Flexible PVC.
- Color: Black

UNIT : mm

Item No.		Mounting Hole	Chassis Thickness	O.D.	I.D.	H	Packing
Open	Close						
GM-0603	GMC-0603	6.2	1.5	8.5	3.0	4.7	100pcs
GM-0705	GMC-0705	7.4	1.5	10.2	5.0	4.7	
GM-1006	GMC-1006	10.2	1.5	13.3	6.4	6.5	
GM-1108S	GMC-1108S	11.1	2.1	15.5	7.8	7.8	
GM-1108	GMC-1108	11.2	2.8	15.5	7.8	9.0	
GM-1410	GMC-1410	14.1	3.2	19.5	10.5	6.4	
GM-2015	GMC-2015	20.3	1.5	23.7	15.5	6.1	
GM-2518	GMC-2518	25.3	1.3	29.9	18.9	7.2	
GM-3225	GMC-3225	31.9	1.3	38.1	25.0	7.8	

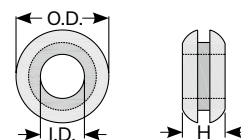

GM TYPE

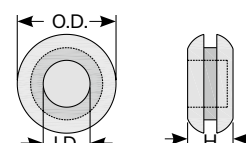

GMC TYPE

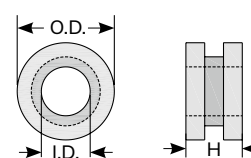

GM-1108

※ GMQ, GMCQ is softer.

UNIT : mm

Item No.		Mounting Hole	Chassis Thickness	O.D.	I.D.	H	Packing
Open	Close						
GMQ-0603	GMCQ-0603	6.2	1.5	8.5	3.0	4.7	100pcs
GMQ-0705	GMCQ-0705	7.4	1.5	10.2	5.0	4.7	
GMQ-1006	GMCQ-1006	10.2	1.5	13.3	6.4	6.5	
GMQ-1108S	GMCQ-1108S	11.1	2.1	15.5	7.8	7.8	
GMQ-1108	GMCQ-1108	11.2	2.8	15.5	7.8	9.0	
GMQ-1410	GMCQ-1410	14.1	3.2	19.5	10.5	6.4	
GMQ-2015	GMCQ-2015	20.3	1.5	23.7	15.5	6.1	
GMQ-2518	GMCQ-2518	25.3	1.3	29.9	18.9	7.2	
GMQ-3225	GMCQ-3225	31.9	1.3	38.1	25.0	7.8	

# 0725 KSS D TYPE HOUSING COVER

- Material : PE
- Color : Natural
- To protect pin connector from dirty.

UNIT : mm

Item No.	L	L1	W	H	H1	Packing	Suitable Socket
HR-9M	11.0	9.2	20.0	7.2	6.1	100pcs	9 pin male
HR-9F	9.2	7.85	18.1	6.5	5.7		9 pin female
HR-15M	10.9	9.1	28.2	7.0	6.0		15 pin male
HR-15F	9.5	7.5	26.5	6.9	5.9		15 pin female
HR-25M	10.9	9.1	42.0	7.3	6.3		25 pin male
HR-25F	9.5	7.8	40.6	6.8	5.9		25 pin female
HR-37F	10.9	8.3	57.5	7.5	6.5		37 pin female

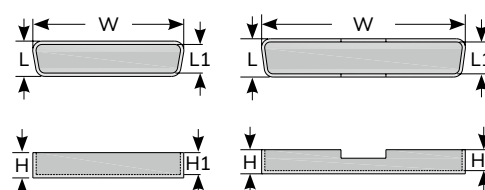

Standard design

HR-37F

# 0727 KSS ROUND HOUSING COVER



- Material : PE or UL94V-2 flame rated, UL approved Nylon 66.
- Color : Natural
- To protect pin connector from dirty.

UNIT : mm

Item No.		O.D.	I.D.	H	H1	Packing
PE	NYLON 66					
RHR-6PE	RHR-6	8.2	7.3	8.8	6.1	100pcs
RHR-7PE	RHR-7	8.0	2.5	3.0	6.6	
RHR-8PE	RHR-8	10.4	6.9	8.0	8.3	

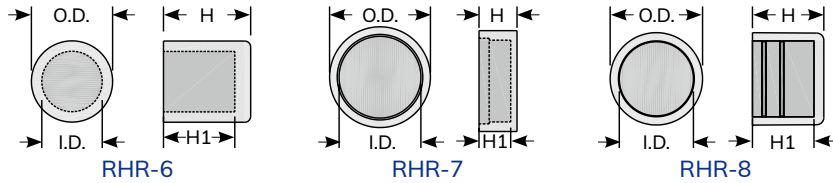

# 0730 KSS USB HOUSING COVER



- Material : PE
- Color : Natural
- To protect pin connector from dirty.

UNIT : mm

Item No.	Type	Dimension	Packing
USB-1	USB Type A	As Figure	100pcs
USB-3	USB Type C	As Figure	

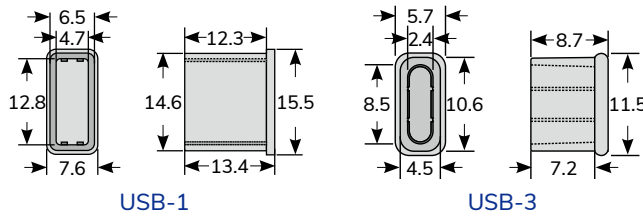

# 0730 KSS USB HOUSING COVER



- Material: PE
- Color : Black
- Function: Dust cover for USB plug.

UNIT : mm

Item No.	Dimension	Packing
USB-2	As Figure	100pcs

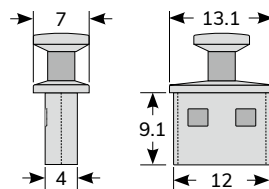



# 0731 KSS FUSE COVER



- Material : Flexible PVC.
- Color : Clear.
- To protect fuse from dirty.

UNIT : mm

Item No.	Dimension	Packing
FR-1	As Figure	100pcs

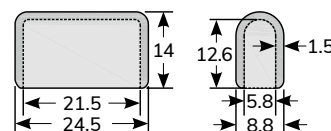

# 0733 KSS PLUG COVER



- Material: PE
- Color : Black
- To protect plug from dirty

UNIT : mm

Item No.	Dimension	Design	Packing
PR-2	As Figure	Standard	100pcs
PR-3		Ground	

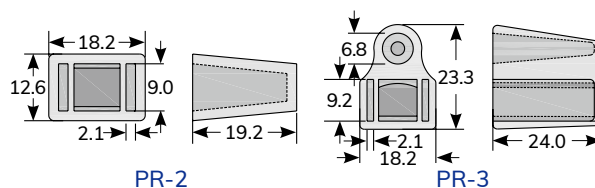
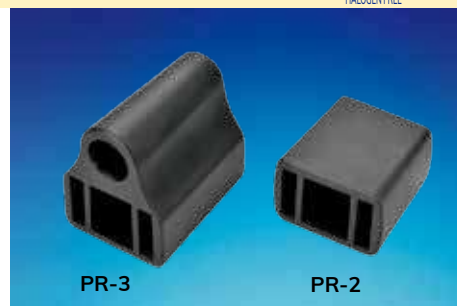

# 0735 KSS SCREW PLUG



- Material : PP
- Color : Natural
- For automotive hydraulic pump plugs into the hole.

UNIT : mm

Item No.	External thread	Dimension	Packing
HPA-16	M16x1.5	As Figure	100pcs

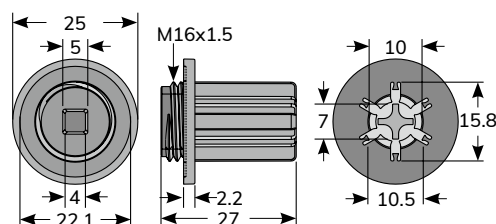



Wiring Ducts				
Cable Markers				
Cable Ties				
Wrapping Bands				
Cable Clamps & Tie Mounts				
Glands, Bushings				
Conduits				
<b>Bushings</b>				
Wire Connectors				
Tubes				
Cable Clips				
PCB Parts				
Fasteners				

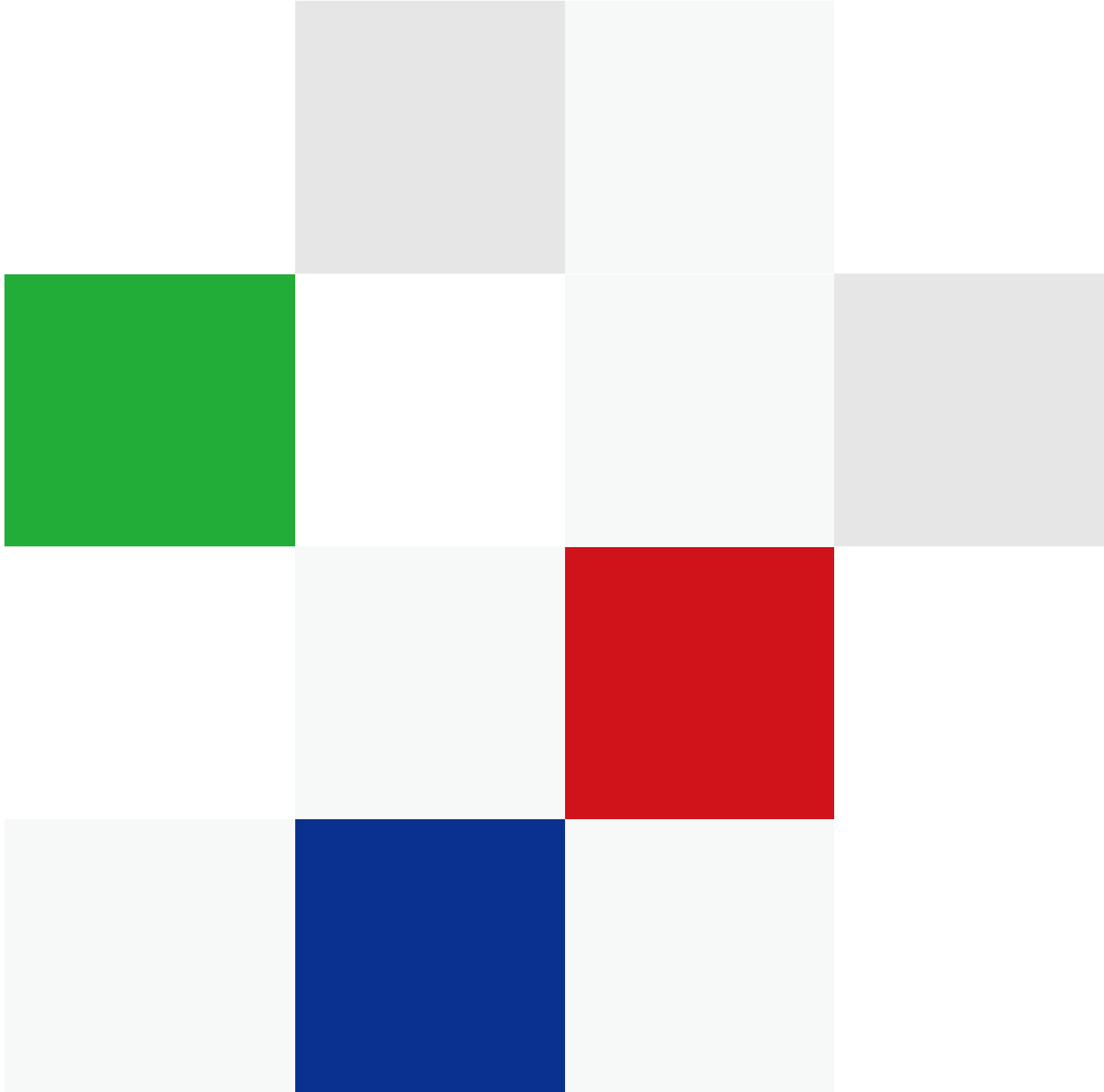

# Wire Connectors

Wiring  
Ducts

Cable  
Markers

Cable  
Ties

Wrapping  
Bands

Cable Clamps  
& Tie Mounts

Glands,  
Bushings

Conduits

Bushings

**Wire  
Connectors**

Tubes

Cable  
Clips

PCB  
Parts

Fasteners

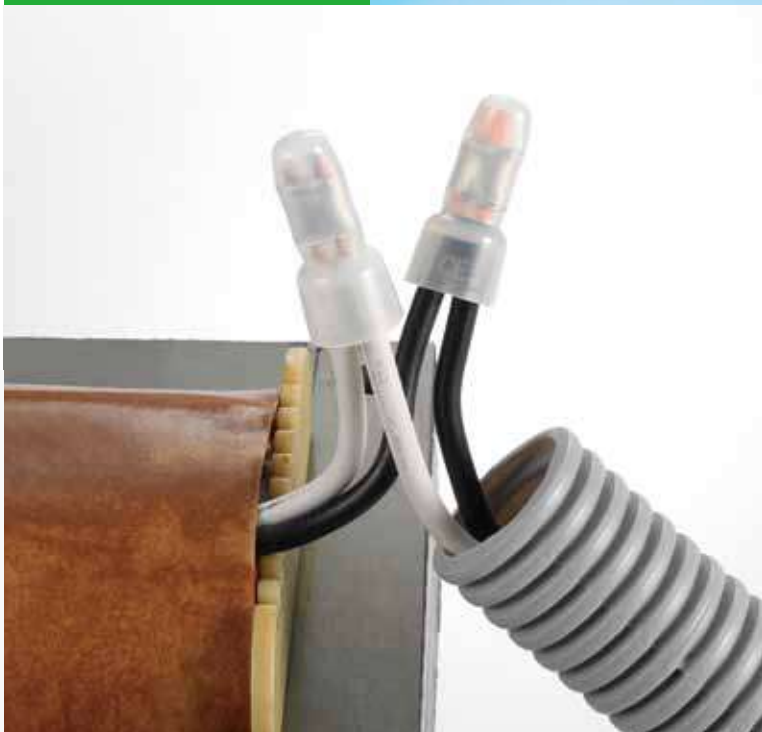

# 0801 KSS CLOSE-END WIRE CONNECTOR



- Material : Copper tube with UL94V-2 / V-0 flame rated, UL approved Nylon 66 cover.
- Tested by the glow-wire flammability index (GWFI), at a glow wire temperature of 800°C for UL94V-2 grade and 960°C for UL94V-0 grade.
- Insert pre-stripped wires then use crimping tool to hold wires firmly.

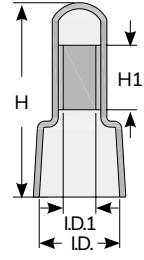

UNIT : mm

Item No.		I.D.	I.D.1	H	H1	Suitable Wires			Packing
UL94V-2	UL94V-0					mm <sup>2</sup>	AWG	DIN mm <sup>2</sup> d	
CE-1	CE-1V0	7.8	2.4	20.0	7.0	1.25	22-16	0.5-1.75	100pcs
CE-2	CE-2V0	8.0	3.0	20.0	7.0	2.0	16-14	1.0-3.0	
CE-5	CE-5V0	10.5	3.8	25.3	8.0	5.5	12-10	2.5-6.0	
CE-8	CE-8V0	12.0	4.7	27.8	8.5	8.0	8	4.0-9.0	

AWG	2	4	6	8	10	12	14	16	18	20	22	24	26	28	30	32
mm <sup>2</sup>	33.4	20.8	13.2	8.4	5.3	3.3	2.1	1.3	0.83	0.52	0.33	0.21	0.13	0.08	0.05	0.03

# 0804 KSS WIRE NUT DRIVE



- Material : Nylon 66
- Color : Black
- Socket tool used with electrical screwdriver, make fast and easy installation for screw on wire connector.



Item No.	Packing
SWT-1	1 pc

# 0808 KSS SCREW ON WIRE CONNECTOR



- Material: Steel with UL94V-2 flame rated thermoplastic cover.
- Strip wires before application.
- Rated at 600 volt max. for building wiring.
- Temp. 105°C (221°F)
- Spring design provided more secure connection.



UNIT : mm

Item No.	O.D.	I.D.	H	Wire Combination		Color	Packing
				JIS	AWG		
SW-71BH	8.6	6.5	15.2	Max. 1 #1.25 w/1 #0.75 w/1 #0.5 Min. 2 #0.5	Max. 1 #16 w/1 #18 w/1 #20 Min. 2 #22	Grey	100pcs
SW-72BH	9.9	7.1	17.7	Max. 3 #1.25 Min. 2 #0.5	Max. 3 #16 Min. 2 #22	Blue	
SW-73BH	12.7	9.7	22.0	Max. 4 #1.25 w/1 #0.5 Min. 1 #0.75 w/1 #0.5	Max. 4 #16 w/1 #20 Min. 1 #18 w/1 #20	Orange	
SW-74BH	14.0	11.0	24.6	Max. 2 #3.5 w/2 #2.0 Min. 3 #0.5 Sol	Max. 2 #12 w/2 #14 Min. 3 #20 Sol	Yellow	
SW-76BH	16.3	13.1	26.5	Max. 2 #5.5 Sol w/2 #3.5 Str Min. 3 #0.75	Max. 2 #10 Sol w/2 #12 Str Min. 3 #18	Red	

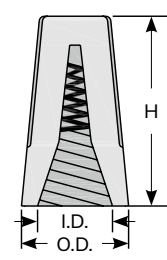

# 0809 KSS SCREW ON WIRE CONNECTOR



E 116091 236592

- Material: Steel with UL94V-2 flame rated thermoplastic cover.
- Two wing makes move easy twist on termination of wires.
- Strip wires before application.
- Rated at 600 volt max. for building wiring.
- Temp. 105°C (221°F)
- Spring design provided more secure connection.



UNIT : mm

Item No.	I.D.	W	H	Wire Combination		Color	Packing
				JIS	AWG		
SW-Y11H	9.8	18.2	25.8	Max. 2 #3.5 w/1 #2.0 Min. 3 #0.75	Max. 2 #12 w/1 #14 Min. 3 #18	Yellow	100pcs
<b>NEW</b> SW-Y12PH	11.2	18.3	29.0	Max. 4 #3.5 Min. 3 #0.5 Sol	Max. 4 #12 Min. 3 #22 Sol	Brown	
SW-Y12H	13.0	23.0	31.8	Max. 5 #3.5 Sol Min. 3 #1.25	Max. 5 #12 Sol Min. 3 #16	Red	
SW-Y13H	14.9	25.5	33.3	Max. 3 #5.5 Min. 3 #2.0 w/1 #0.75	Max. 3 #10 Min. 3 #14 w/1 #18	Grey	
SW-Y14H	17.8	31.8	40.0	Max. 3 #8 w/1 #3.5 Min. 2 #5.5 w/1 #3.5	Max. 3 #8 w/1 #12 Min. 2 #10 w/1 #12	Blue	

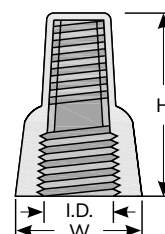

# 0810 KSS MID-WAY WIRE CONNECTOR



HALOGEN FREE OPTION

- Material: Brass with PP / UL94V-2 flame rated, UL approved Nylon 66 cover.
- Insert wires on the grooves of connector, clamps down the plastic body and electricity can be conducted.
- Quick installation without stripping wire.
- Can be joined for connection



UNIT : mm

Item No.		Wire Combination	Connection	Color	Packing
PP	NYLON66				
KW-1	KW-1N	18AWG-14AWG		Blue	100pcs
KW-2	KW-2N	18AWG-14AWG		Blue	
KW-3	KW-3N	22AWG-18AWG		Red	
KW-4	KW-4N	18AWG-14AWG		Blue	
KW-5	KW-5N	12AWG-10AWG		Yellow	
KW-6	KW-6N	22AWG-20AWG		Red	
KW-6L	KW-6LN	18AWG-14AWG		Red	
	KW-10N	22AWG-18AWG		Red	
	KW-11N	16AWG-14AWG		Blue	
	KW-12N	12AWG-10AWG		Yellow	



Wiring Ducts			
Cable Markers			
Cable Ties			
Wrapping Bands			
Cable Clamps & Tie Mounts			
Glands, Bushings			
Conduits			
Bushings			
<b>Wire Connectors</b>			
Tubes			
Cable Clips			
PCB Parts			
Fasteners			

# Tubes

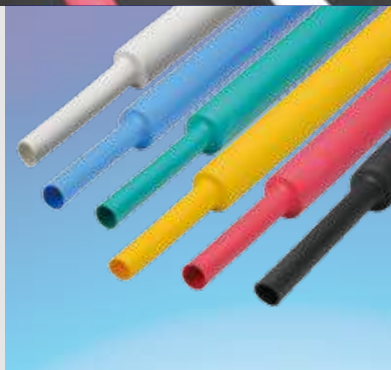
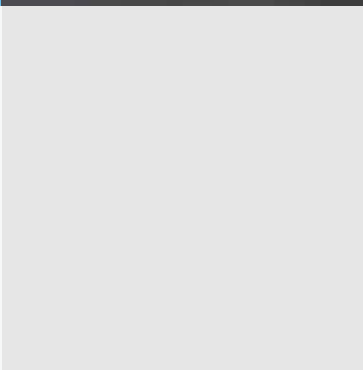
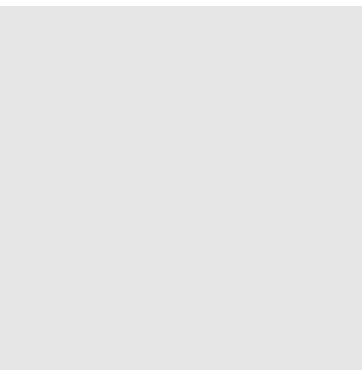
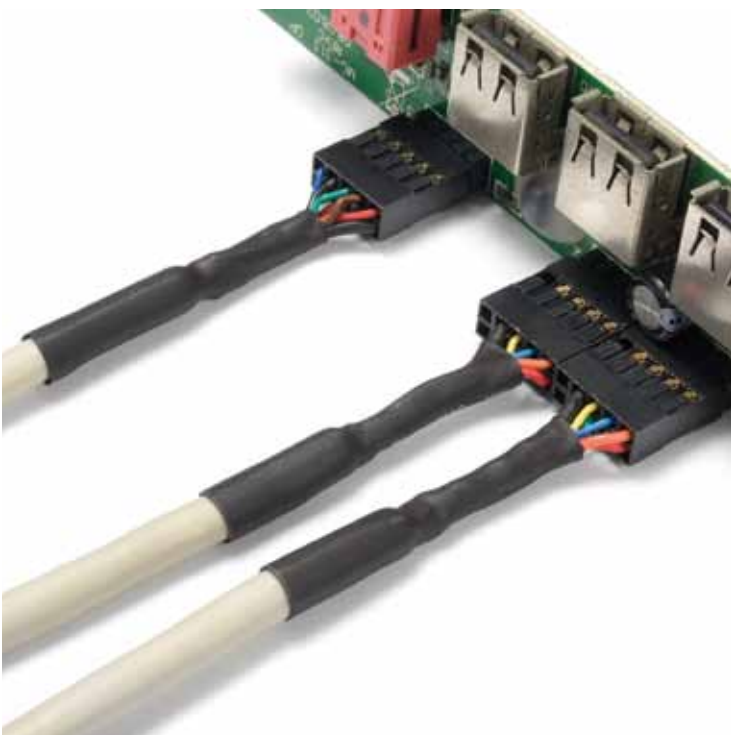

Wiring  
Ducts

Cable  
Markers

Cable  
Ties

Wrapping  
Bands

Cable Clamps  
& Tie Mounts

Glands,  
Bushings

Conduits

Bushings

Wire  
Connectors

**Tubes**

Cable  
Clips

PCB  
Parts

Fasteners

# 0901 KSS VINYL WIRE END CAP

- Material: Flexible PVC.
- Suitable for all kinds of switchboard and complicated machinery to tell different colors. Soft and flexible material can be used for different shapes of end terminals, easy to tighten and take off.
- Feature 1: Smooth and bright surface
  - 2: Stable thickness
  - 3: Consistant length
  - 4: Even opening ends
  - 5: Tidy the wiring works
- Standard color: Red, White, Blue, Yellow, Black, Green. (Brown, Grey available upon request)

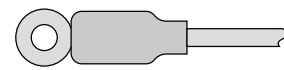
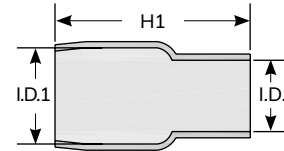

UNIT : mm

Item No.	Dimension		Length H1	JIS	Color	Packing
	I.D.	I.D.1				
V-1.25	3.1	3.3	15.0	1.25	Red \ Blue \ White \ Black \ Yellow \ Green Brown \ Grey	100pcs
V-2	3.7	4.5	14.0	2.0		
V-3.5	4.0	5.1	18.0	3.5		
V-5.5	4.9	5.7	20.0	5.5		
V-8	6.2	6.8	21.0	8		
V-14	8.0	8.8	28.0	14		
V-22	9.8	11.6	29.0	22		
V-38	13.0	14.5	33.0	38		
V-60	14.0	16.4	39.0	60		
V-80	15.8	18.2	46.0	80		
V-100	18.2	21.6	48.9	100		
V-125	20.3	23.6	52.5	125		
V-150	22.3	25.3	62.7	150		50pcs
V-200	24.4	31.4	61.4	200		
V-250	27.0	32.8	71.5	250		25pcs
V-325	29.5	35.3	73.0	325		
V-400	37.3	45.1	78.4	400		
V-500	40.2	48.0	82.3	500		
V-630	44.6	53.8	85.8	630		

# 0906 KSS VINYL TUBE

- Material: Flexible PVC.



UNIT : mm

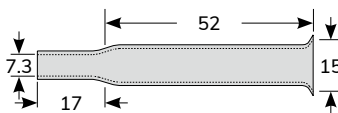

VT-10

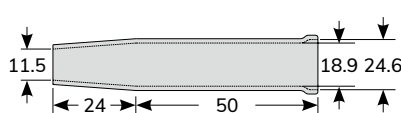

VT-11

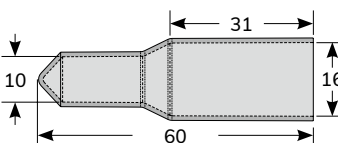

VT-12

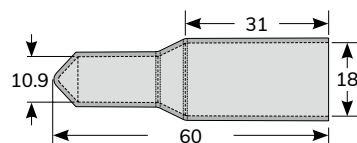

VT-13



# 0905 KSS VINYL WIRE END MARKER CAP

RoHS

OPTION

● Welcome for special request.

UNIT : mm

Item No.	Dimension		Length H1	JIS	Color	Packing
	I.D.	I.D.1				
MV-1.25	3.1	3.3	15.0	1.25	Red、Blue、 White、Black、 Yellow、Green	100pcs
MV-2	3.7	4.5	14.0	2.0		
MV-3.5	4.0	5.1	18.0	3.5		
MV-5.5	4.9	5.7	20.0	5.5		

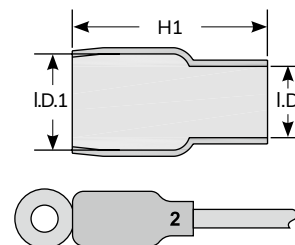

CUSTOMIZE PRINTING

# 0907 KSS END CAP

RoHS

OPTION

● Material: Flexible PVC.

● Color : Black

※ EP-0308S has THINNER WALL.

UNIT : mm

Item No.	I.D.	H1	Color	Packing
EP-0308S	3.0	8.8	THINNER WALL	100pcs
EP-0308	3.0	8.0		
EP-0312	3.2	12.0		
NEW EP-0321	3.2	20.7		
EP-0408	4.0	8.0		
EP-0412	4.8	12.0		
EP-0416	4.8	16.0		
EP-0418S	4.0	18.0		
NEW EP-0418	4.8	18.0	Black	
EPA-0505	5.7	5.0	(Red、	
EP-0510	5.7	10.0	Blue、	
EP-0513	5.7	13.5	White、	
EP-0612	6.3	12.0	Black、	
EP-0708	7.6	8.0	Yellow、	
EP-0804	8.0	4.0	Green	
EP-0809	7.8	9.5	Upon	
EP-0824	8.0	24.0	Request)	
EP-0905	9.4	5.0		
EP-0912	9.4	12.0		
NEW EP-1113	11.4	13.0		
EP-1124	11.3	24.0		
EP-1216	12.0	16.0		
EP-1420	14.0	20.0		
EP-1435	14.0	35.0		
EP-1713	17.8	13.0		

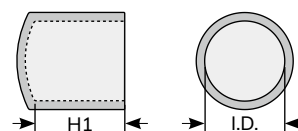

EP TYPE

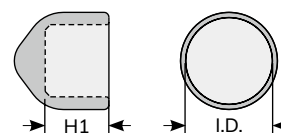

EPA-0505

# 0908 KSS HEXAGONAL PROTECTION CAP



- Material: PE
- Color : Black

UNIT : mm

Item No.	Nut	O.D.	H	H1	Packing
HPM-8	M8	16.6	15.3	8	100pcs

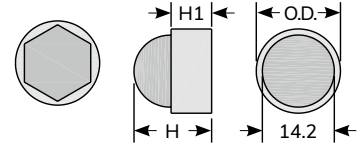

# 0908 KSS SCREW PROTECTION CAP



- Material: PE
- Color : Black

UNIT : mm

Item No.	Dimension				Packing
	O.D.	I.D.	H	H1	
SCP-0709	13	7.5	10.2	9.3	100pcs

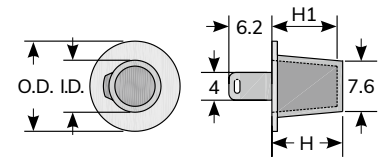

# 0909 KSS SCREW PROTECTION CAP



- Material: Flexible PVC.
- Feature: Easy to install without using any tool.
- Color: Grey

UNIT : mm

Item No.	Suitable Screw	O.D.	I.D.	I.D.1	H	H1	Packing
SCA-1948	3/4"	39.2	26.3	19.0	52.0	48.0	40pcs
SCA-2656	1 "	50.4	37.6	25.2	62.5	56.2	
SCA-3270	1 1/4"	62.0	48.0	30.9	77.4	70.4	20pcs

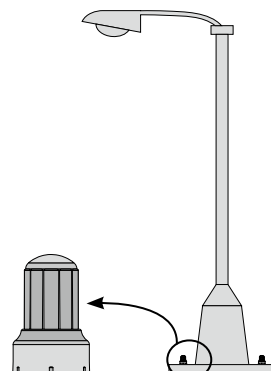
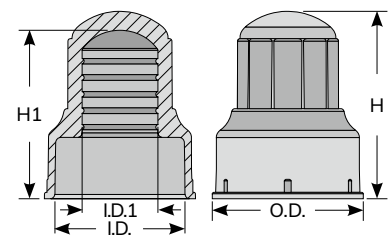

# 0910 KSS ALLIGATOR CLIP

RoHS

OPTION

● Material: Nickel plated iron with PVC tube.

UNIT : mm

Item No.	I.D.	H1	Ampere	Color	Remarks	Packing
AC-1	3	35	2A	Red 、 Black (Blue 、 Green 、 White 、 Yellow Upon Request)	Clip c/w Tube	100pcs
AC-2	3	40	3A			
AC-3	3.4	47	5A			
AC-4	4	68	10A			
AC-5	5	80	20A			

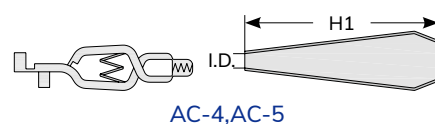
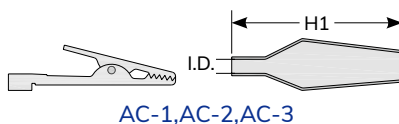

# 0915 KSS TUBE OF ALLIGATOR CLIP

RoHS

OPTION

● Material: Flexible PVC.

UNIT : mm

Item No.	I.D.	I.D.1	H1	Color	Remarks	Packing
BC-1	3.0	5	35	Red 、 Black (Blue 、 Green 、 White 、 Yellow Upon Request)	Tube	100pcs
BC-2	3.0	6	40			
BC-3	3.4	9	47			
BC-4	4.0	15	68			
BC-5	5.0	15	80			

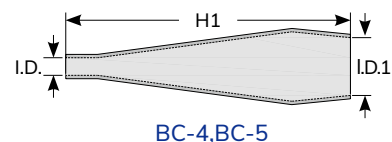
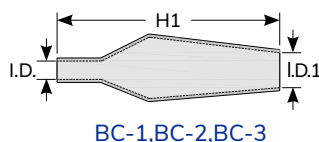

## 0920 KSS HEAT SHRINKING SLEEVE

- Material: PVC.
- Shrink temperature: min. 100°C
- Radial Shrinking: 45~50%; Longitudinal Shrinking: 8~15%
- Continuous operating temperature: -15 to 105°C.
- Thickness : 0.08mm
- Used for color distinction and insulation of busbar in controll panel. To be shrunk by blower or hot water.

UNIT : mm

Item No.	I.D.	H1	Shrinkable Range	After Shrinkage	Color	Packing
HS-6.5	4.1	6.5	6.5~3.6	2.3	Red 、 White 、 Blue 、 Black (Yellow 、 Green Upon Request)	100M Per Roll
HS-8.5	5.2	8.5	8.5~4.5	2.9		
HS-12	7.6	12	12~6.5	4.2		
HS-15	10	15	15~8.5	5.5		
HS-20	13	20	20~11	7.2		
HS-30	19	30	30~16	10.5		
HS-40	25	40	40~22	13.8		
HS-50	32	50	50~28	17.6		
HS-60	38	60	60~33	20.9		
HS-70	44	70	70~37	24.4		
HS-80	50	80	80~42	27.5		
HS-100	63	100	100~55	34.7		
HS-120	76	120	120~65	41.8		
HS-150	95	150	150~90	52.3		
HS-170	108	170	170~94	59.4		
HS-200	127	200	200~110	69.9		

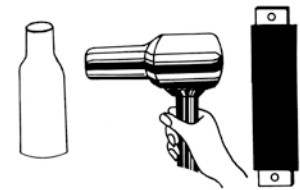
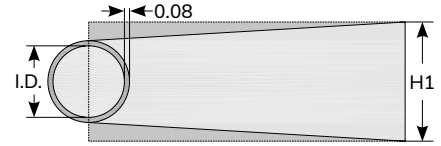

## 0933 KSS HOT MELT ADHESIVE TUBE

- Material: PE Copolymer.
- To connect optical fiber and prevent corrosions.
- ※ Available on request.

UNIT : mm

Item No.	Inside Diameter D	Wall Thickness t	Length
HM-0.55	0.55	0.25	1M
HM-1.1	1.1	0.35	
HM-1.5	1.5	0.4	
HM-3.5	3.5	0.4	

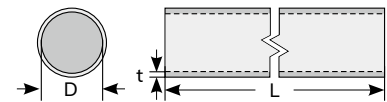

## 0933 KSS OVAL HOT MELT ADHESIVE TUBE

- Material: PE Copolymer.
- To connect optical fiber and prevent corrosions.
- ※ Available on request.

UNIT : mm

Item No.	D	d	Wall Thickness t	No. of Fibers	Length
HM-3014	3.80	2.20	0.40	4	1M
HM-3216	3.90	2.25	0.35	8	
HM-3819	4.55	2.65	0.40	12	

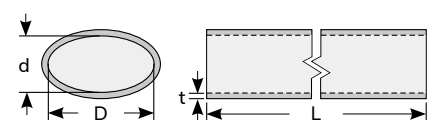

# 0931 KSS PVC TUBE

- Material: Flexible PVC.
- Continuous operating temperature: 105°C
- UL/CSA Recognized, flammability VW-1.
- Feature: PVC tube is flame retardant, flexible and high reliability products.
- Standard Colors: Black (other colors are available upon request).



## Standard Size

UNIT : mm

300V		600V		Inside Diameter	Nom. Size	Packing
Item No.	Wall Thickness	Item No.	Wall Thickness			
NHS-065	0.30±0.06	NHS-065V6	0.47±0.08	0.65±0.10	22AWG	500 M / Roll
NHS-080	0.37±0.06	NHS-080V6	0.47±0.08	0.80±0.10	20AWG	
NHS-090	0.37±0.06	NHS-090V6	0.47±0.08	0.90±0.10	19AWG	
NHS-100	0.37±0.06	NHS-100V6	0.47±0.08	1.00±0.15	18AWG	
NHS-120	0.37±0.06	NHS-120V6	0.60±0.08	1.20±0.15	17AWG	
NHS-130	0.37±0.06	NHS-130V6	0.60±0.08	1.30±0.15	16AWG	
NHS-150	0.37±0.06	NHS-150V6	0.60±0.08	1.50±0.15	15AWG	
NHS-170	0.37±0.06	NHS-170V6	0.60±0.08	1.70±0.15	14AWG	
NHS-190	0.40±0.06	NHS-190V6	0.60±0.08	1.90±0.20	13AWG	
NHS-210	0.40±0.06	NHS-210V6	0.60±0.08	2.10±0.20	12AWG	
NHS-240	0.40±0.06	NHS-240V6	0.60±0.08	2.40±0.20	11AWG	
NHS-270	0.40±0.06	NHS-270V6	0.60±0.08	2.70±0.20	10AWG	
NHS-300	0.47±0.08	NHS-300V6	0.60±0.08	3.00±0.25	9AWG	
NHS-330	0.47±0.08	NHS-330V6	0.60±0.08	3.30±0.25	8AWG	
NHS-370	0.47±0.08	NHS-370V6	0.60±0.08	3.70±0.25	7AWG	
NHS-420	0.47±0.08	NHS-420V6	0.60±0.08	4.20±0.30	6AWG	
NHS-470	0.47±0.08	NHS-470V6	0.60±0.08	4.70±0.30	5AWG	200 M / Roll
NHS-530	0.47±0.08	NHS-530V6	0.60±0.08	5.30±0.30	4AWG	
NHS-590	0.47±0.08	NHS-590V6	0.60±0.08	5.90±0.30	3AWG	
NHS-660	0.47±0.08	NHS-660V6	0.60±0.08	6.60±0.30	2AWG	
NHS-740	0.47±0.08	NHS-740V6	0.60±0.08	7.40±0.35	1AWG	
NHS-830	0.47±0.08	NHS-830V6	0.60±0.08	8.30±0.35	0AWG	

## Inch Size

300V		600V		Inside Diameter		Packing
Item No.	Wall Thickness	Item No.	Wall Thickness	inch	mm	
NHS-800	0.47±0.08	NHS-800V6	0.60±0.08	5/16"	8.0±0.35	150 M / Roll
NHS-950	0.60±0.08	NHS-950V6		3/8"	9.5±0.35	200 M / Roll
NHS-111		NHS-111V6		7/16"	11.1±0.35	
NHS-127		NHS-127V6		1/2"	12.7±0.35	150 M / Roll

Wiring Ducts

Cable Markers

Cable Ties

Wrapping Bands

Cable Clamps & Tie Mounts

Glands, Bushings

Conduits

Bushings

Wire Connectors

Tubes

Cable Clips

PCB Parts

Fasteners

# Technical Data

- Wiring Ducts
- Cable Markers
- Cable Ties
- Wrapping Bands
- Cable Clamps & Tie Mounts
- Glands, Bushings
- Conduits
- Bushings
- Wire Connectors
- Tubes
- Cable Clips
- PCB Parts
- Fasteners

Property & Spec.	Products Name	Standard	Sizes (As supplied)	Operating Temp.	Shrinking Properties				Standard Colors
					Shrinking start Temp.	Shrinking Complete Temp.	Radial Shrinking	Longitudinal Shrinking	
General Use, Transparent	Sumitube A		1.3 ~ 25.2 mm	-55 ~ 105°C	75°C	115°C	40% Min.	15% Max.	Black, Brown, Red, Orange, Yellow, Green, Blue, Violet, Grey, White, Clear
Weather Resistant, Transparent	Sumitube A4		3/64 ~ 2 inch	-55 ~ 105°C	75°C	110°C	50% Min.	15% Max.	Black, Brown, Red, Orange, Yellow, Green, Blue, Violet, Grey, White, Clear
Low Temperature Shrinking, Transparent	Sumitube C		1.6 ~ 25.5 mm	-55 ~ 105°C	60°C	115°C	40% Min.	15% Max.	Black, Brown, Red, Orange, Yellow, Green, Blue, Violet, Grey, White, Clear
PVC Material	Sumitube V	UL	1.5 ~ 25 mm	-30 ~ 105°C	50°C	160°C	50% Min.	30% Max.	Clear
High Voltage Resistant	Irrax sleeve SBI		15 ~ 120 mm	-40 ~ 110°C	70°C	100°C	60% Min.	15% Max.	Red
Flexible, Halogen-free	WK32	UL	0.6 ~ 50 mm	-55 ~ 125°C	70°C		50% Min.	0 ± 5%	Black, Red, Yellow, Green, Blue, White
Flexible	Sumitube B2	UL, CSA SAE-AMS	3/64 ~ 4 inch	-55 ~ 135°C	60°C	90°C	50% Min.	0 ± 5%	Black, Brown, Red, Orange, Yellow, Green, Blue, Violet, Grey, White
Semi-rigid, Friction-resistant	Sumitube B8	UL, CSA	3/64 ~ 1 inch	-55 ~ 125°C	75°C	130°C	50% Min.	0 ± 5%	Black, Brown, Red, Orange, Yellow, Green, Blue, Violet, Grey, White
Transparent, Semi-rigid, Friction-resistant	Sumitube K2	UL, SAE-AMS	3/64 ~ 1 inch	-55 ~ 175°C	95°C	170°C	50% Min.	10% Max.	Clear
Meltable Adhesive, Waterproof, High Shrink Ratio	Irrax sleeve SCM2		102 ~ 1250 mm	-55 ~ 120°C	70°C	90°C	60% Min.	10% Max.	Black
	Sumitube SA3		5.8 ~ 17.8 mm	-40 ~ 130°C	80°C	135°C	75% Min.	10% Max.	Black
Filled up type, Meltable Polyolefin	Sumitube W3F2	UL, CSA	1/8 ~ 1 inch	-55 ~ 125°C	60°C	110°C	60% Min.	15% Max.	Black, Brown, Red, Orange, Yellow, Green, Blue, Violet, Grey, White
	Sumitube W		1.7 ~ 14.0 mm	-55 ~ 105°C	75°C	115°C	60 ~ 100%	15% Max.	Outer Layer/Inner Layer = Black/Grey, Clear/Clear

© All items are RoHS compliant.

● Other SUMIPAC heat-shrinkable tubings (features, dimensions, and purposes) available upon request, please feel free to contact us.

# 0927 KSS HEAT-SHRINKABLE TUBE (WK32)



- Material: Non-halogen flexible polyolefin.
- Standard color: Black, other colors available on request.
- Shrink temperature: min. 70°C
- Shrink ratio: 2:1; Radial Shrinking: min. 50%; Longitudinal Shrinking: ±5%
- Continuous operating temperature: -55 to 125°C
- UL Recognized, flammability VW-1, UL rating voltage 600V
- Application: Insulation & protection for cable and connector.



## ■ Technical Data

Property	Test Method	Typical Performance
Tensile strength (MPa)	UL 224	≥10.4
Ultimate elongation(%)	UL 224	≥200
Tensile strength after heat aged (MPa)	UL224; 158°CX168h	≥7.3
Elongation after heat aged (%)	UL224; 158°CX168h	≥100
Flammability	UL 224	VW-1
Dielectric strength (kV/mm)	UL 224	≥15
Volume resistivity (Ω•cm)	UL 224	≥1×10 <sup>14</sup>

UNIT : mm

Item No.	Size	As supplied		After shrinkage		Application range	Packing (Spool)
		Internal Diameter min.	Wall Thickness nominal	Internal Diameter Max.	Wall Thickness nominal		
WK32-1	1.0	1.5±0.2	0.20±0.05	≤0.65	0.36±0.10	0.75~0.9	400M
WK32-1.5	1.5	2.0±0.2	0.20±0.05	≤0.85	0.36±0.10	0.95~1.4	
WK32-2	2.0	2.5±0.2	0.20±0.05	≤1.0	0.45±0.10	1.1~1.8	
WK32-2.5	2.5	3.0±0.2	0.20±0.05	≤1.3	0.45±0.10	1.35~2.3	
WK32-3	3.0	3.5±0.2	0.20±0.05	≤1.5	0.45±0.10	1.6~2.7	
WK32-3.5	3.5	4.0±0.2	0.23±0.05	≤1.8	0.45±0.10	1.85~3.2	
WK32-4	4.0	4.7±0.2	0.25±0.05	≤2.0	0.45±0.10	2.1~3.6	200M
WK32-5	5.0	5.5±0.2	0.28±0.05	≤2.5	0.56±0.10	2.6~4.5	
WK32-6	6.0	6.5±0.2	0.28±0.05	≤3.0	0.56±0.10	3.1~5.4	
WK32-7	7.0	7.5±0.3	0.30±0.05	≤3.5	0.56±0.10	3.7~6.3	100M
WK32-8	8.0	8.5±0.3	0.30±0.08	≤4.0	0.56±0.10	4.2~7.2	
WK32-9	9.0	9.5±0.3	0.30±0.08	≤4.5	0.56±0.10	4.7~8.0	
WK32-10	10.0	10.5±0.3	0.30±0.08	≤5.0	0.56±0.10	5.2~9.0	
WK32-11	11.0	11.5±0.3	0.30±0.08	≤5.5	0.56±0.10	5.7~10.0	
WK32-12	12.0	12.5±0.3	0.30±0.08	≤6.0	0.56±0.10	6.2~11.0	
WK32-13	13.0	13.5±0.3	0.35±0.08	≤6.5	0.70±0.10	6.7~12.0	50M
WK32-14	14.0	14.5±0.3	0.35±0.10	≤7.0	0.70±0.10	7.3~13.0	
WK32-15	15.0	15.5±0.4	0.35±0.10	≤7.5	0.70±0.10	7.8~14.0	
WK32-16	16.0	16.5±0.4	0.35±0.10	≤8.0	0.70±0.10	8.3~15.0	
WK32-18	18.0	19.0±0.5	0.35±0.10	≤9.0	0.70±0.10	9.3~17.0	
WK32-20	20.0	22.0±0.5	0.40±0.10	≤10.0	0.83±0.10	10.4~19.0	
WK32-22	22.0	24.0±0.5	0.40±0.12	≤11.0	0.83±0.15	11.4~21.0	50M
WK32-25	25.0	26.0±0.5	0.45±0.12	≤12.5	0.90±0.15	12.8~24.0	
WK32-28	28.0	29.0±0.5	0.45±0.12	≤14.0	0.90±0.15	14.4~29.0	
WK32-30	30.0	31.5±1.0	0.45±0.12	≤15.0	1.00±0.15	16.0~29.0	

- Wiring Ducts
- Cable Markers
- Cable Ties
- Wrapping Bands
- Cable Clamps & Tie Mounts
- Glands, Bushings
- Conduits
- Bushings
- Wire Connectors
- Tubes
- Cable Clips
- PCB Parts
- Fasteners

# 0927 KSS HALOGEN FREE HEAT-SHRINKING TUBINGS

Wiring Ducts  
Cable Markers  
Cable Ties  
Wrapping Bands  
Cable Clamps & Tie Mounts  
Glands, Bushings  
Conduits  
Bushings  
Wire Connectors  
Tubes  
Cable Clips  
PCB Parts  
Fasteners

UNIT : mm

Item No.	As supplied		After Shrinkage		Packing (Spool)
	125°C UL	Inside Diameter min.	Wall Thickness nominal	Inside Diameter max.	
NHR2-1	1.4±0.2	0.20	0.50	0.33	200M / Roll
NHR2-1.5	2.0±0.2	0.20	0.75	0.36	
NHR2-2	2.5±0.2	0.20	1.00	0.44	
NHR2-2.5	3.0±0.2	0.25	1.25	0.44	
NHR2-3	3.5±0.3	0.25	1.50	0.44	
NHR2-3.5	4.0±0.3	0.25	1.75	0.44	
NHR2-4	4.5±0.3	0.25	2.00	0.44	100M / Roll
NHR2-5	5.4±0.3	0.25	2.50	0.56	
NHR2-6	6.4±0.4	0.25	3.00	0.56	
NHR2-7	7.4±0.4	0.25	3.50	0.56	50M / Roll
NHR2-8	8.4±0.4	0.25	4.00	0.56	
NHR2-9	9.4±0.4	0.25	4.50	0.56	
NHR2-10	10.4±0.4	0.25	5.00	0.56	
NHR2-11	11.4±0.4	0.25	5.50	0.56	
NHR2-12	12.4±0.4	0.25	6.00	0.56	
NHR2-13	13.5±0.4	0.30	6.50	0.69	
NHR2-14	14.5±0.4	0.30	7.00	0.69	
NHR2-15	15.5±0.5	0.30	7.50	0.69	
NHR2-16	16.8±0.5	0.30	8.00	0.69	
NHR2-18	18.7±0.5	0.35	9.00	0.77	
NHR2-20	21.2±0.6	0.35	10.00	0.77	
NHR2-22	23.2±0.6	0.40	11.00	0.77	
NHR2-25	26.1±0.8	0.40	12.50	0.87	
NHR2-28	29.0±1.0	0.50	14.00	0.87	
NHR2-30	32.0±1.0	0.50	15.00	0.87	



※ SUMITOMO Authorized Distributor

- Material: non-halogen flexible polyolefin.
- Standard color: Black, other colors available on request.
- Shrink temperature: min. 100°C
- Shrink ratio: 2:1; Radial Shrinking: min. 50%; Longitudinal Shrinking: 5±5%
- Continuous operating temperature: -55 to 125°C
- UL Recognized, flammability VW-1, rating voltage 600V
- Application: Insulation & protection for cable and connector.

# 0927 KSS HALOGEN FREE HEAT-SHRINKING TUBINGS

UNIT : mm

Item No.	As supplied		After Shrinkage		Packing (Spool)	
	125°C UL	Inside Diameter min.	Wall Thickness nominal	Inside Diameter max.		Wall Thickness nominal
NHR4-1	1.4±0.2	0.10	0.50	0.20	200M / Roll	
NHR4-1.5	1.9±0.2		0.75	0.20		
NHR4-2	2.3±0.2		1.00	0.20		
NHR4-2.5	2.9±0.2	0.15	1.25	0.25		100M / Roll
NHR4-3	3.3±0.3		1.50	0.25		
NHR4-3.5	3.8±0.3		1.75	0.25		
NHR4-4	4.4±0.3		2.00	0.25		
NHR4-5	5.5±0.4		2.50	0.25	50M / Roll	
NHR4-6	6.5±0.4		3.00	0.28		
NHR4-7	7.5±0.4		3.50	0.28		
NHR4-8	8.5±0.4		4.00	0.28		
NHR4-9	9.5±0.4		4.50	0.28		
NHR4-10	10.5±0.5		5.00	0.28		



※ SUMITOMO Authorized Distributor

- Material: non-halogen flexible polyolefin.
- Standard color: Black, other colors available on request.
- Shrink temperature: min. 100°C
- Thin wall; Shrink ratio: 2:1; Radial Shrinking: min. 50%; Longitudinal Shrinking: 5±5%
- Continuous operating temperature: -55 to 125°C
- UL Recognized, flammability VW-1, rating voltage 300V
- Application: Insulation & protection for cable and connector.



# 0927 KSS HEAT-SHRINKABLE TUBINGS

## SUMITUBE A (SA)

- Material: polyolefin.
- Standard color: Black, Clear, other colors available on request.
- Shrink temperature: min. 115°C
- Shrink ratio: 1.5:1; Radial Shrinking: Approx. 40%; Longitudinal Shrinking: max.15%
- Continuous operating temperature: -55 to 105°C
- Application: Insulation & protection for cable and connector.

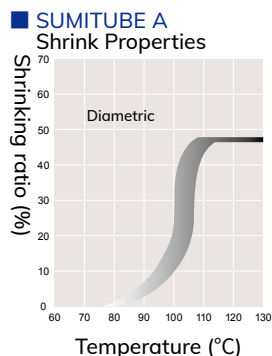

※ SUMITOMO Authorized Distributor

## SUMITUBE C (SC)

- Material: polyolefin.
- Standard color: Black, Clear, other colors available on request.
- Shrink temperature: min. 90°C
- Shrink ratio: 1.5:1; Radial Shrinking: Approx. 40%; Longitudinal Shrinking: max.15%
- Continuous operating temperature: -55 to 105°C
- Application: Insulation & protection for cable and connector.

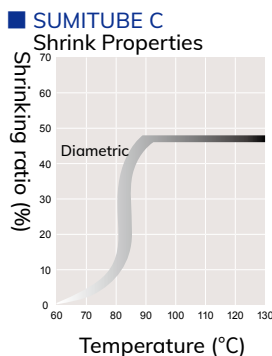

UNIT : mm

Item No.		As supplied		After Shrinkage		Packing	
A	C	Inside Diameter min.	Wall Thickness nominal	Inside Diameter max.	Wall Thickness nominal	A (Spool)	C (Spool)
SA-1		1.3±0.2	0.20	0.6	0.40±0.1	200M	200M
	SC-1	1.6±0.2	0.20	0.6	0.40±0.1	100M	100M
SA-1.5	SC-1.5	2.1±0.2	0.20	0.8	0.40±0.1	200M	100M
SA-2	SC-2	2.6±0.2	0.20	1.3	0.40±0.1	200M	200M
SA-2.5	SC-2.5	3.1±0.2	0.20	1.5	0.40±0.1	200M	200M
SA-3	SC-3	3.6±0.3	0.20	1.8	0.40±0.1	200M	200M
SA-3.5	SC-3.5	4.1±0.3	0.20	2.0	0.40±0.1	200M	200M
SA-4	SC-4	4.6±0.3	0.20	2.3	0.40±0.1	200M	200M
SA-5	SC-5	5.6±0.3	0.20	2.9	0.40±0.1	100M	100M
SA-6	SC-6	6.5±0.3	0.25	3.5	0.50±0.1	100M	100M
SA-7	SC-7	7.5±0.3	0.25	4.2	0.50±0.1	50M	50M
SA-8	SC-8	8.5±0.3	0.25	4.7	0.50±0.1	50M	50M
SA-9	SC-9	9.5±0.4	0.25	5.4	0.50±0.1	50M	50M
SA-10	SC-10	10.5±0.4	0.25	6.0	0.50±0.1	50M	50M
SA-11	SC-11	11.5±0.4	0.25	7.0	0.50±0.1	50M	50M
SA-12	SC-12	12.4±0.4	0.30	7.6	0.60±0.1	50M	50M
SA-13	SC-13	13.4±0.4	0.30	8.0	0.60±0.1	50M	50M
SA-14	SC-14	14.4±0.4	0.30	9.0	0.60±0.1	50M	50M
SA-15	SC-15	15.4±0.4	0.30	10.0	0.60±0.1	50M	50M
SA-16	SC-16	16.4±0.4	0.30	10.5	0.60±0.1	50M	50M
SA-18	SC-18	18.4±0.4	0.30	11.5	0.60±0.1	50M	50M
SA-20	SC-20	20.4±0.4	0.30	13.0	0.60±0.1	50M	50M
SA-22	SC-22	22.4±0.4	0.30	14.0	0.60±0.1	50M	50M
SA-25	SC-25	25.5±0.5	0.30	15.0	0.60±0.1	50M	50M

# 0927 KSS HEAT-SHRINKABLE TUBINGS



- Material: semi-rigid flame-retarded PVDF.
- Color: colors available on request.
- Shrink temperature: min. 150°C
- Shrink ratio: 2:1; Radial change: min. 50%; Longitudinal Shrinking: max. 10%
- Continuous operating temperature: -55 to 175°C
- SAE-AMS/UL recognized, flammabilityVW-1
- Application: Protection for wire and devices which are used in motorcycle or under high temperature or exposed to chemicals and oils.



※ SUMITOMO Authorized Distributor

### Shrink Properties

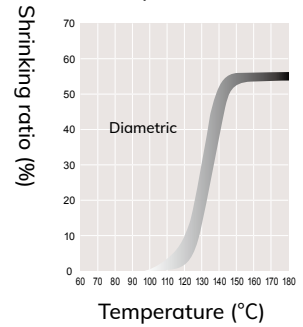

### RECOGNITION

ITEMS	UL224
File NO.	E70631
Potential rating	-
Temperature rating	-
Flammability	VW-1

UNIT : mm

Item No.	Size (inch)	As supplied		After Shrinkage		Packing (Spool)
		Inside Diameter min.	Wall Thickness nominal	Inside Diameter max.	Wall Thickness	
K2-3/64	3/64	1.2	0.10	0.6	0.25±0.05	305M
K2-1/16	1/16	1.6	0.10	0.8	0.25±0.05	
K2-3/32	3/32	2.4	0.12	1.2	0.27±0.04	152.5M
K2-1/8	1/8	3.2	0.12	1.6	0.27±0.04	
K2-3/16	3/16	4.8	0.12	2.4	0.27±0.04	61M
K2-1/4	1/4	6.4	0.14	3.2	0.33±0.05	
K2-3/8	3/8	9.5	0.14	4.8	0.33±0.05	
K2-1/2	1/2	12.7	0.14	6.4	0.33±0.05	
K2-3/4	3/4	19.1	0.18	9.5	0.43±0.07	
K2-1	1	25.4	0.20	12.7	0.48±0.07	

# 0927 KSS HEAT-SHRINKABLE TUBINGS



- Material: polyolefin.
- Color: Colors available on request.
- Shrink temperature: min. 90°C
- Shrink ratio: 2:1; Radial Shrinking: min. 50%; Longitudinal Shrinking: ±5%
- Continuous operating temperature: -55 to 135°C
- UL/CSA Recognized, flammability VW-1, rating voltage 600V
- Application: Insulation & protection for cable and connector.



※ SUMITOMO Authorized Distributor

### Shrink Properties

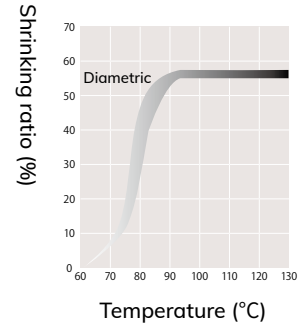

### RECOGNITION

ITEMS	UL224	CSA C22.2
File NO.	E48762	LR33298
Potential rating	600V	600V
Temperature rating	125°C	125°C
Flammability	VW-1	VW-1

UNIT : mm

Item No.	As supplied		After Shrinkage		Packing (Spool)
	Inside Diameter min.	Wall Thickness nominal	Inside Diameter max.	Wall Thickness	
B2-3/64	1.6±0.3	0.2	0.6	0.41±0.07	305M
B2-1/16	2.0±0.3	0.2	0.8	0.43±0.07	
B2-3/32	2.7±0.3	0.25	1.2	0.51±0.07	152.5M
B2-1/8	3.5±0.3	0.25	1.6	0.51±0.07	
B2-3/16	5.2±0.3	0.3	2.4	0.51±0.07	61M
B2-1/4	6.8±0.4	0.3	3.2	0.64±0.07	
B2-3/8	10.0±0.4	0.3	4.8	0.64±0.07	
B2-1/2	13.2±0.5	0.3	6.4	0.64±0.07	
B2-3/4	20.0±0.6	0.4	9.5	0.76±0.07	
B2-1	26.6±0.8	0.45	12.7	0.89±0.12	
B2-1-1/2	39.3±1.0	0.45	19.1	1.02±0.15	
B2-2	52.7±1.5	0.5	25.4	1.14±0.17	
B2-3	77.7±1.5	0.55	38.1	1.27±0.20	30.5M
B2-4	106.0±3.0	0.6	50.8	1.40±0.22	

# 0927 KSS HEAT-SHRINKABLE TUBINGS WITH INNER GLUE

- Material: polyolefin with glue.
- Color: black.
- Shrink temperature: min. 100°C
- Shrink ratio: 3:1; Radial change: min. 60%; Longitudinal Shrinking: max. 10%
- Continuous operating temperature: -55 to 120°C
- Application: Waterproof protection for outdoor cable and connector.

UNIT : mm

Item No.	As supplied		After Shrinkage		Packing (Length)
	Inside Diameter min.	I.D. Without Adhesive	Wall Thickness (max)		
SCM-04	10.2	3.8	1.5	1.22M	
SCM-07	19.0	5.6	2.0		
SCM-11	28.0	9.5	2.0		
SCM-13	33.0	10.2	2.3		
SCM-15	38.1	12.7	2.3		
SCM-17	44.0	14.0	2.3		
SCM-20	52.0	18.2	2.3		
SCM-27	70.0	25.5	2.3		
SCM-35	90.0	30.0	2.5		
SCM-50	125.0	40.0	2.5		



※ SUMITOMO Authorized Distributor

■ Shrink Properties

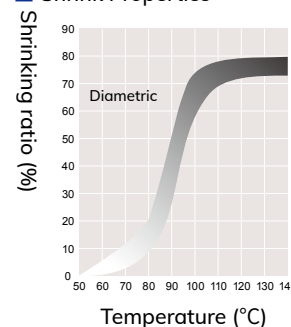

Medium wall thickness with adhesive

■ MARKING on the tubing  
IRRAW SLEEVE SCM2 (SIZE)

# 0927 KSS HEAT-SHRINKABLE TUBINGS WITH INNER GLUE



- Material: polyolefin with glue.
- Color: black.
- Shrink temperature: min. 110°C
- Shrink ratio: 3:1; Radial change: min. 60%; Longitudinal Shrinking: max. 15%
- Continuous operating temperature: -55 to 125°C
- UL/CSA Recognized, rating voltage 600V
- Application: Waterproof, anticorrosion, insulation and protection on different cable connecting.

※ The thickness of wall includes glue.

UNIT : mm

Item No.	Size (inch)	As supplied		After Shrinkage			Packing (Length)
		Inside Diameter min.	Wall Thickness nominal	Inside Diameter max.	Wall Thickness nominal	Adhesive Thickness nominal	
W3F2-1/8	1/8	3.2	0.35	0.6	0.95	0.35	1.22M
W3F2-3/16	3/16	4.8	0.45	1.5	1.1	0.6	
W3F2-1/4	1/4	6.4	0.45	2.0	1.2	0.65	
W3F2-3/8	3/8	9.5	0.50	3.0	1.3	0.65	
W3F2-1/2	1/2	12.7	0.55	4.0	1.4	0.75	
W3F2-3/4	3/4	19.1	0.65	8.0	1.6	0.8	
W3F2-1	1	25.4	0.75	10.2	1.9	0.8	



※ SUMITOMO Authorized Distributor

■ Shrink Properties

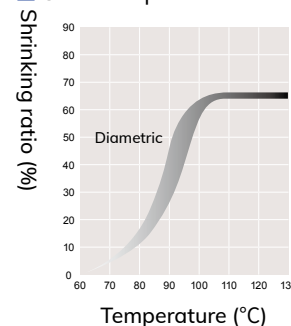

■ RECOGNITION

ITEMS	UL224	CSA C22.2
File NO.	E75077	LR33298
Potential rating	600V	600V
Temperature rating	125°C	125°C
Flammability	-	-

■ MARKING on the tubing  
CSA HS X PO MELTABLE LINER 125°C

◆ SUMITOMO-K SUMITUBE W3F2 843 125°C

# 0927 KSS HEAT-SHRINKABLE TUBINGS WITH INNER GLUE

- Material: polyolefin with glue.
- Color: black.
- Shrink temperature: min. 135°C
- Shrink ratio: 4:1; Radial change: min. 75%; Longitudinal Shrinking: max. 10%
- Continuous operating temperature: -40 to 130°C
- Application: High shrink ratio(4:1) and waterproof protection for harness joints of motor vehicles.



※ SUMITOMO Authorized Distributor

UNIT : mm

Item No.	As supplied		After Shrinkage			Packing (Length)
	Inside Diameter min.	Wall Thickness nominal	Inside Diameter max.	Wall Thickness nominal	Adhesive Thickness nominal	
SSA3-1	5.8	0.45	1.26	1.20	0.56	1.22M
SSA3-2	7.5	0.60	1.64	1.52	0.76	
SSA3-3	10.9	0.70	2.40	1.91	1.02	
SSA3-4	17.8	0.80	4.45	2.41	1.37	

■ Shrink Properties

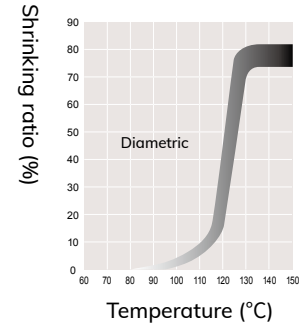

SA3-(SIZE)

# 0927 KSS HEAT-SHRINKABLE TUBINGS

- Material: polyolefin.
- Color: Red.
- Shrink ratio: 2.5:1; Radial Shrinking: min. 60%; Longitudinal Shrinking: max. 15%
- Continuous operating temperature: -40 to 120°C



※ SUMITOMO Authorized Distributor

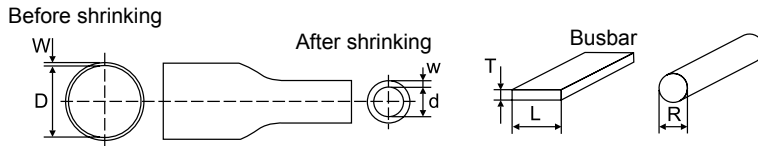

UNIT : mm

Item No.	As supplied		After shrinkage		Suitable Busbar Range		Packing (Spool)
	Internal Diameter min.	Wall Thickness nominal	Internal Diameter Max.	Wall Thickness nominal	Square shape L+ T Minimum (min.) Maximum (max.)	Round shape R Minimum (min.) Maximum (max.)	
SBI 300 (24KV)	15	1.1	6	2.0	12 ~ 18	6.5 ~ 12	25M
SBI300-15	15	1.1	6	2.0	12 ~ 18	6.5 ~ 12	
SBI300-30	30	1.1	12	2.3	22 ~ 38	13.5 ~ 25	
SBI300-50	50	1.1	20	2.5	36 ~ 65	22.0 ~ 43	
SBI300-75	75	1.1	30	2.5	55 ~ 95	33.0 ~ 63	
SBI300-100	100	1.1	40	2.5	70 ~ 130	44.0 ~ 86	
SBI300-120	120	1.3	50	3.0	90 ~ 165	55.0 ~ 105	

Item No.	As supplied		After shrinkage		Suitable Busbar Range		Packing (Spool)
	Internal Diameter min.	Wall Thickness nominal	Internal Diameter Max.	Wall Thickness nominal	Square shape L+ T Minimum (min.) Maximum (max.)	Round shape R Minimum (min.) Maximum (max.)	
SBI 350 (36KV)	25	1.6	10	4.0	17 ~ 28	11.0 ~ 20	25M
SBI350-25	25	1.6	10	4.0	17 ~ 28	11.0 ~ 20	
SBI350-40	40	1.6	16	4.0	28 ~ 45	18.0 ~ 32	
SBI350-65	65	1.6	25	4.0	45 ~ 67	28.0 ~ 47	
SBI350-100	100	1.6	40	4.0	67 ~ 102	44.0 ~ 72	

※ IRRAX SLEEVE SBI 300 / 350 high insulation, can lead to the compact space of switch-gear and shorten distance of phase to phase bus-bar.

# Cable Clips

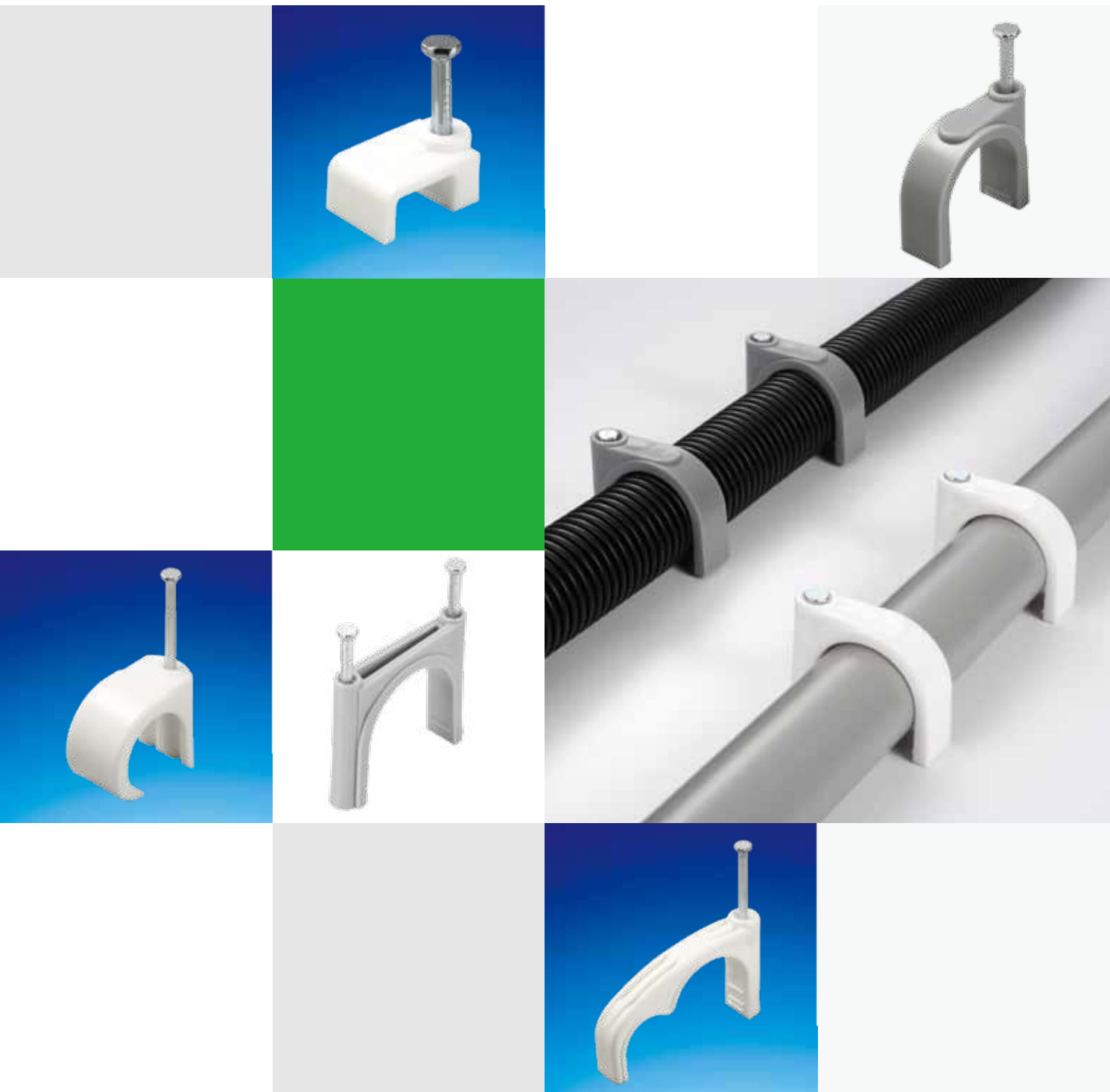

Wiring  
Ducts

Cable  
Markers

Cable  
Ties

Wrapping  
Bands

Cable Clamps  
& Tie Mounts

Glands,  
Bushings

Conduits

Bushings

Wire  
Connectors

Tubes

**Cable  
Clips**

PCB  
Parts

Fasteners

# 1001 KSS NAIL CABLE CLIP

- Material: PE with nail.
- Color: Grey
- With nail inserted, Steel nail for Masonry.
- Applied for telephone cords.

UNIT : mm

Item No.	W	H1	H	Suitable Wires	Nails	Packing
NT-1	4.8	2.5	7	0.2m/m <sup>2</sup> 2C & 4C	2.0X15	100pcs

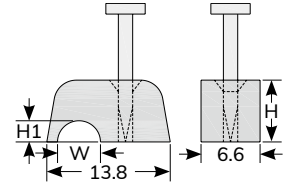

# 1001 KSS NAIL CABLE CLIP

- Material: PE with nail.
- Color: White ( others available upon request )
- With nail inserted, Steel nail for Masonry.

UNIT : mm

Item No.	W	H1	H	Nails	Packing
NT-0204	4.1	2.2	4.9	2.0X20	100pcs
NT-0407	7.0	4.0	6.9	2.0X20	
NT-0711	9.0	6.4	9.6	2.0X35	
NT-1114	13.2	8.6	13.4	2.0X35	

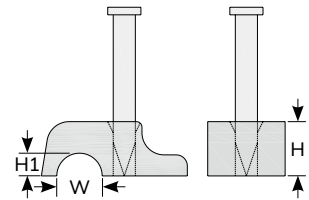

# 1005 KSS NAIL CABLE CLIP

- Material: PE with nail.
- Color: White ( others available upon request )
- With nail inserted, Steel nail for Masonry.
- Applied for telephone cords.

UNIT : mm

Item No.	W	H1	H	Suitable Wires	Nails	Packing
NF-0.18	4.5	2.7	4.3	0.8mm/m <sup>2</sup> 2c	2.0X15	100pcs
NFR-1	5.1	3.0	6.8	0.8mm/m <sup>2</sup> 2c	2.5X18	

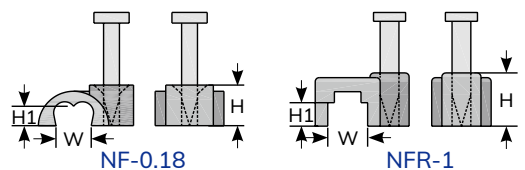

# 1010 KSS NAIL CABLE CLIP

- Material: PE with nail.
- Color: White ( others available upon request )
- With nail inserted, Steel nail for Masonry.



## Thin Nail

UNIT : mm

Item No.	W	H1	H	Suitable Wires	Nails	Packing
NF-2.0S	8.5	5.2	8.0	1.5mm <sup>2</sup> Flat T&E	2.0X25	100pcs
NF-2.2S	10.0	6.5	10.0	2.5mm <sup>2</sup> Flat T&E	2.0X25	

## Standard Nail

NF-0.25	2.1	1.2	4.5		1.65X15	100pcs
※NF-0.7	5.5	3.1	5.5		2.0X15	
※NF-1.2	6.2	3.8	6.4		2.0X15	
NF-1.4	6.4	4.1	7.0		2.0X25	
※NF-1.6	8.0	5.0	8.0	1.0mm <sup>2</sup> Flat T&E	2.0X15	
※NF-2.0	8.5	5.2	8.0	1.5mm <sup>2</sup> Flat T&E	2.5X18	
※NF-2.2	10.0	6.5	10.0	2.5mm <sup>2</sup> Flat T&E	2.5X18	
NF-2.3	10.2	4.6	8.0		2.0X25	
NF-2.6	13.5	8.1	11.6	6.0mm <sup>2</sup> Flat T&E	2.5X22	
NF-2.8	15.0	8.7	12.8		2.5X22	
NF-3.0	18.0	9.5	12.9	10mm <sup>2</sup> Flat T&E	2.5X27	
NF-3.2	19.0	11.1	14.2	16mm <sup>2</sup> Flat T&E	2.5X27	
※NF-5.0	49.0	26.0	33.0		4.0X50	
NFT-4.0	11.6	6.4	9.7	4.0mm <sup>2</sup> T&E	2.0X25	100pcs
NF-1122	21.1	11.3	14.5		2.5X35	

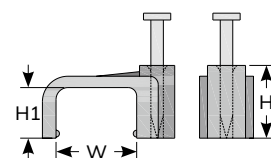

Standard design

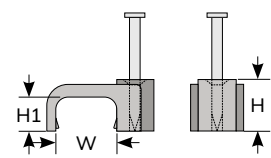

NFT-4.0

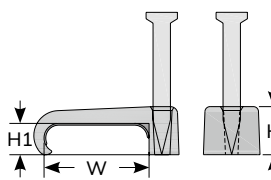

NF-1122

# 1011 KSS NAIL CABLE CLIP

- Material: PE with nail.
- With nail inserted, Steel nail for Masonry.
- Applied for telephone cords.



UNIT : mm

Item No.	W	H1	H	Suitable Wires	Nails	Color	Packing
NJ-9.5NA	9.5	4.5	9.0	1.5mm <sup>2</sup> Flat T&E	2.0X25	Natural	100pcs
NJ-12NA	12.4	6.0	10.4	2.5mm <sup>2</sup> Flat T&E	2.0X25		

Item No.	W	H1	H	Suitable Wires	Nails	Color	Packing
NFP-2.1	9.3	4.0	8.7	2.5mm <sup>2</sup> Twin	2.0X25	White	100pcs
NF-2.6S	11.9	6.2	9.6	4.0mm <sup>2</sup> Twin	2.0X25		
NF-2.8S	15.0	6.8	11.0	6.0mm <sup>2</sup> Twin	2.0X25		

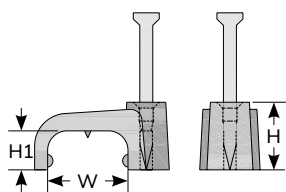

NJ TYPE

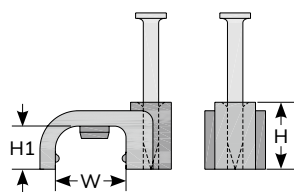

NFP-2.1

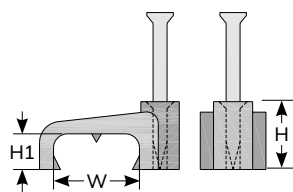

NF-2.6S

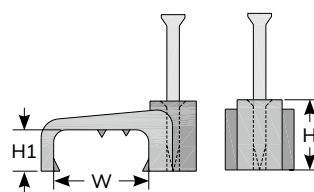

NF-2.8S

# 1010 KSS NAIL CABLE CLIP



- Material: PE with nail.
- Color: Grey ( others available upon request )
- With nail inserted, Steel nail for Masonry.
- Applied for telephone cords.

UNIT : mm

Item No.	W	H1	H	Suitable Wires	Nails	Packing
NFTT-1.0GYT	7.6	4.0	6.8	1.0mm <sup>2</sup> Flat T&E	2.0X25	100pcs
NFTT-1.5GYT	8.5	4.5	7.3	1.5mm <sup>2</sup> Flat T&E	2.0X25	
NFTT-2.5GYT	10.3	5.3	8.2	2.5mm <sup>2</sup> Flat T&E	2.0X25	
NFTT-4.0GYT	11.9	6.4	9.5	4.0mm <sup>2</sup> Flat T&E	2.0X25	
NFTT-6.0GYT	13.3	7.3	10.5	6.0mm <sup>2</sup> Flat T&E	2.0X30	
NFT-10GYT	17.1	8.7	11.6	10mm <sup>2</sup> Flat T&E	2.0X30	
NFT-16GYT	20.2	10.0	13.2	16mm <sup>2</sup> Flat T&E	2.5X35	
NFT-1.5GYT	9.8	4.4	6.7	1.0mm <sup>2</sup> +1.5mm <sup>2</sup> Flat 3C+E	2.0X25	
NFD-1.0GYT	17.0	4.5	7.2	1.0mm <sup>2</sup> +1.5mm <sup>2</sup> DOUBLE Flat T&E	2.0X25	
NFD-2.5GYT	19.0	5.3	8.6	2.5mm <sup>2</sup> DOUBLE Flat T&E	2.0X25	

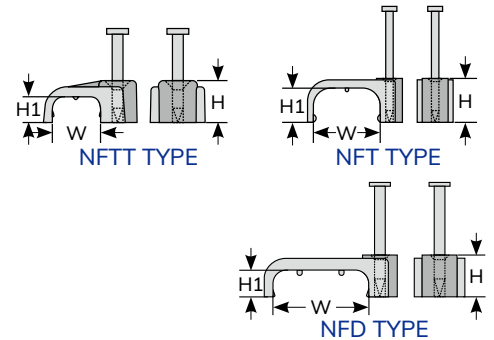

# 1011 KSS NAIL CABLE CLIP



- Material: PE with nail.
- With nail inserted, Steel nail for Masonry.
- Applied for telephone cords.

UNIT : mm

Item No.	W	H1	H	Suitable Wires	Nails	Color	Packing
NF-0204NA	4.0	2.0	4.0	Bellwire	1.2X15	Natural	100pcs
NF-0305NA	4.6	3.3	5.2	Speaker cable	1.2X20		
NF-0406NA	5.8	3.8	5.9	Sheath Twin Cable	1.4X20		
NF-0508GY	7.9	4.9	7.5	1.0 & 1.5mm <sup>2</sup> T&E	2.0X25	Grey	
NF-0610GY	9.8	5.8	8.2	2.5mm <sup>2</sup> T&E	2.0X25		
NF-0714GY	11.8	6.5	9.3	4 & 6mm <sup>2</sup> T&E	2.5X25		
NF-0918GY	16.7	9.4	12.2	10 & 16mm <sup>2</sup> T&E	2.5X30		
NFD-0508GY	15.1	4.5	7.0	2x1.0 & 1.5mm <sup>2</sup> T&E	2.5X25		
NFD-0610GY	19.2	5.3	8.4	2x2.5mm <sup>2</sup> T&E	2.5X25		

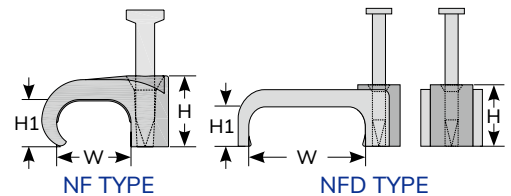

# 1019 KSS NAIL CABLE CLIP



- Material: PE with nail.
- With nail inserted, Steel nail for Masonry.
- Applied for telephone cords.

UNIT : mm

Item No.	W	H1	H	Suitable Wires	Nails	Color	Packing
NU-0203NA	2.8	2.8	4.3	2-3mm Round Cable	1.2X15	Natural	100pcs
NU-0305NA	2.9	3.7	5.6	3-5mm Round Cable	1.2X20		
NU-0507	5.3	6.0	8.0	5-7mm Round Cable	2.0X25		
NU-0710	6.8	7.1	9.5	7-10mm Round Cable	1.6X25	White	
NU-1014	9.4	10.3	13.0	10-14mm Round Cable	2.0X30		
NU-1420	13.1	13.7	17.1	14-20mm Round Cable	2.0X35		
NU-1822	16.4	17.0	19.5	18-22mm Round Cable	2.5X45		
NU-2226	19.5	21.0	24.0	22-26mm Round Cable	2.5X45		

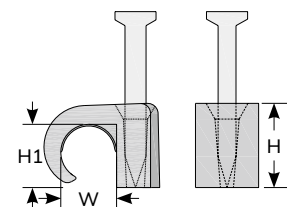



# 1020 KSS NAIL CABLE CLIP

- Material: PE with nail.
- Color: White / Grey / Black ( others available upon request )
- With nail inserted, Steel nail for Masonry.
- Applied for telephone cords.

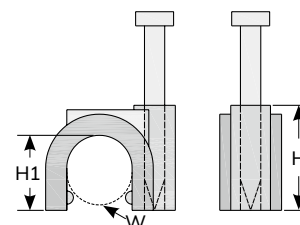

## ◆ Thin Nail

UNIT : mm

Item No.	W	H1	H	Nails	Packing
NC-0.5NS	5.0	5.0	7.6	2.0X20	100pcs
NC-1NS	6.0	6.6	9.0	2.0X20	
NC-2NS	8.0	8.15	12.9	2.0X25	
NC-2.5NS	9.0	9.0	12.0	2.0X25	
NC-3NS	10.0	10.4	12.8	2.0X25	

## ◆ Standard Nail

NC-0.275N	2.75	2.6	4.5	1.65X19	100pcs
NC-0.35N	3.5	3.7	5.9	2.0X15	
NC-0.4N	4.0	4.2	6.6	2.5X18	
NC-0.5N	5.0	5.0	7.6	2.5X18	
NC-0.5NBK (Black)	5.0	5.0	7.6	2.5X18	
NC-1N	6.0	6.6	9.6	2.5X18	
NC-1NBK (Black)	6.0	6.6	9.6	2.5X18	
NC-1NL	6.0	6.9	10.5	2.5X20	
NC-1.5N	7.0	7.5	11.0	2.5X22	
NC-1.5NBK (Black)	7.0	7.5	11.0	2.5X22	
NC-2N	8.0	8.2	12.9	2.5X22	
NC-2.5N	9.0	9.0	12.8	2.5X22	
NC-3N	10.0	10.4	13.8	2.5X25	
NC-3.5N	11.0	12.2	16.6	2.5X27	
NC-4N	12.0	12.3	16.0	2.5X27	
NC-6N	14.0	15.6	20.0	3.0X35	
NC-7N	16.0	17.0	21.7	3.2X38	
NC-7.2N	18.0	17.5	22.4	3.2X38	
NC-7.3N	19.0	18.6	23.3	3.2X38	
NC-7.5N	20.0	18.5	23.5	3.2X38	
NC-8N	22.0	23.0	27.8	3.2X42	
NC-9SN	23.0	24.1	29.0	3.2X47	
NC-9N	25.0	25.0	30.4	3.2X47	
NC-10N	32.0	33.5	40.0	3.6X56	50pcs
<b>NEW</b> NC-10.2N	34.0	34.0	40.0	3.6X56	

# 1020 KSS NAIL CABLE CLIP

- Material: PE with nail.
- Color: Grey
- With nail inserted, Steel nail for Masonry.
- Hook shape design to hold the cable and tube.

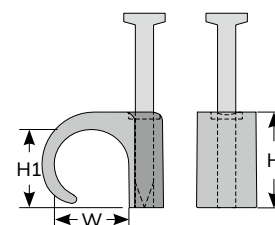

UNIT : mm

Item No.	W	H1	H	Nails	Packing
NU-7N	16.0	17.7	21.5	3.2X38	100pcs
NU-8N	20.0	21.7	26.4	3.2X42	
NU-9N	24.0	25.8	31.0	3.2X47	

# 1020 KSS NAIL CABLE CLIP

- Material: PE with nail.
- Color: White ( others available upon request )
- With nail inserted, Steel nail for Masonry.
- ※ NC-0507L Longer hook

UNIT : mm

Item No.	W	H1	H	Suitable Wires	Nails	Packing
NC-0507S	5.7	5.2	7.1	For 5-7mm Round Cable	1.65X19	100pcs
NC-0507	5.7	5.2	7.1	For 5-7mm Round Cable	2.0X20	
※ NC-0507L	6.1	6.0	8.5	For 5-7mm Round Cable	2.0X20	
NC-0810	7.8	8.0	10.9	For 8-10mm Round Cable	2.0X25	
NC-1115	11.2	11.0	14.7	For 11-15mm Round Cable	2.0X35	
NC-1619	14.4	14.6	18.4	For 16-19mm Round Cable	2.5X40	

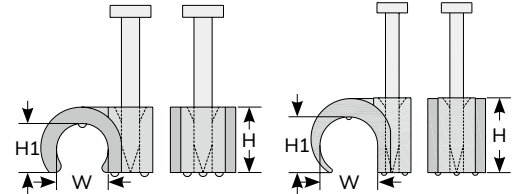

NC-0507S, 0507, 0507L, 0810 NC-1115, 1619

# 1018 KSS NAIL CABLE CLIP

- Material: PE with nail.
- Color: White (others available upon request)
- With nail inserted, Steel nail for Masonry.

UNIT : mm

Item No.	W	H1	H	Suitable Wires	Nails	Packing
NS-0508	5.0	7.0	8.3	5-8mm Round Cable	1.2X20	100pcs
NS-0812	8.0	9.0	11.0	8-12mm Round Cable	2.0X30	
NS-1014	10.0	10.0	12.0	10-14mm Round Cable	2.0X30	
NS-1420	14.0	14.0	16.5	14-20mm Round Cable	2.0X35	
NS-2026	18.0	20.0	23.0	20-26mm Round Cable	2.5X45	

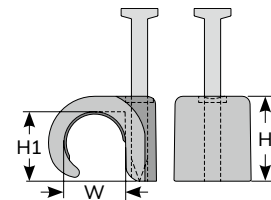

# 1012 KSS DOUBLE NAIL CABLE CLIP

- Material: PE with nail.
- Color: White (others available upon request)
- With nail inserted, Steel nail for Masonry.
- Double nails ensure cable firmly in place.

UNIT : mm

Item No.	W	H1	H	Suitable Wires	Iron	Packing
DNF-13	12.5	5.3	8.0	#14/2,14/3,12/2	1.86X31	100pcs
DNF-17	17.7	11.5	14.7		2.0X44	
DNF-19	18.7	5.3	8.0	#12/3,10/2,10/3	1.86X31	
DNF-24	24.0	13.6	17.1		2.0X44	
DNF-37	36.8	22.5	26.1		2.3X50	50pcs

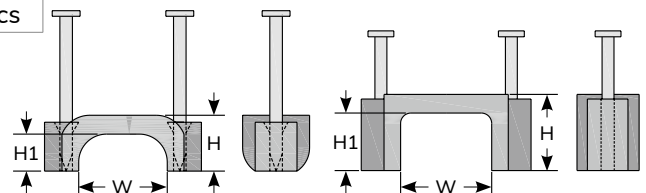

DNF-13, 19

DNF-17, 24, 37

## 1022 KSS DOUBLE NAIL CABLE CLIP



- Material: PE with nail.
- Color: Grey (others available upon request)
- With nail inserted, Steel nail for Masonry.
- Double nails ensure cable firmly in place.

UNIT : mm

Item No.	W	H1	H	Suitable wire	Nails	Packing
DNC-06	17.0	17.7	21.5	3/8" PVC PIPE	2.0X44	50pcs
DNC-10	32.0	33.5	40.0	1" PVC PIPE	3.6X56	20pcs
DNC-12	40.0	41.0	50.0	1 1/4" PVC PIPE	4.0X68	
DNC-15	50.3	50.3	58.3	1 1/2" PVC PIPE	4.0X78	
DNC-20	62.0	62.0	71.0	2" PVC PIPE	4.5X97	

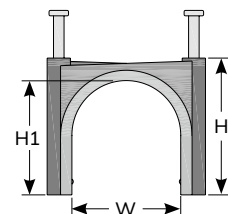

## 1023 KSS COATED COPPER TUBE CLIP



- Material: PE with nail.
- Color: White (others available upon request)
- With nail inserted, Steel nail for Masonry.
- For coated copper pipe of air conditioner.

UNIT : mm

Item No.	W	H1	H2	H	Nails	Packing
MNC-23	43.5	26.0	21.5	33.0	4.0X50	50pcs
MNC-24	50.5	34.5	23.0	42.0	4.0X68	
MNC-25	53.0	38.0	21.5	45.0	4.0X68	25pcs
MNC-35	57.5	38.3	24.0	45.7	4.0X68	
MNC-46	69.3	41.3	32.0	48.0	4.0X78	

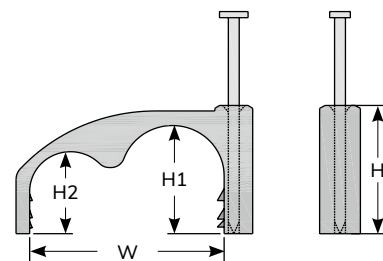

## 1030 KSS PIN PLUG



- Material: PE.
- Color: Natural ( others available upon request )

UNIT : mm

Item No.	W	L	Packing
PP-0518	5	18	100pcs

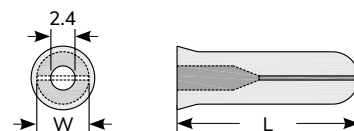



Wiring Ducts			
Cable Markers			
Cable Ties			
Wrapping Bands			
Cable Clamps & Tie Mounts			
Glands, Bushings			
Conduits			
Bushings			
Wire Connectors			
Tubes			
<b>Cable Clips</b>			
PCB Parts			
Fasteners			

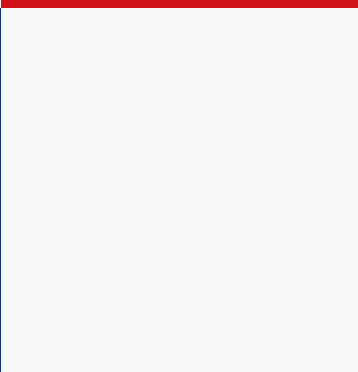
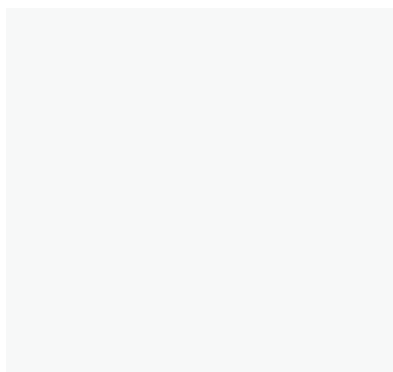
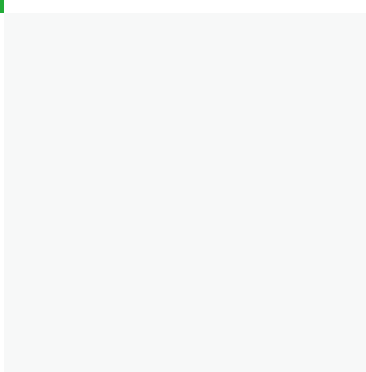
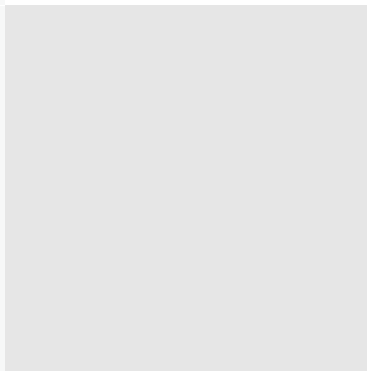
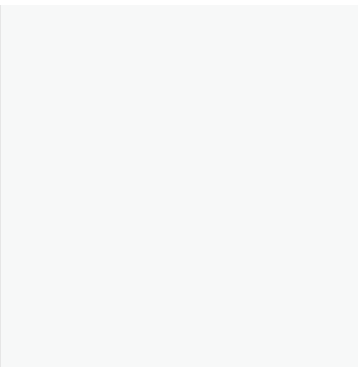
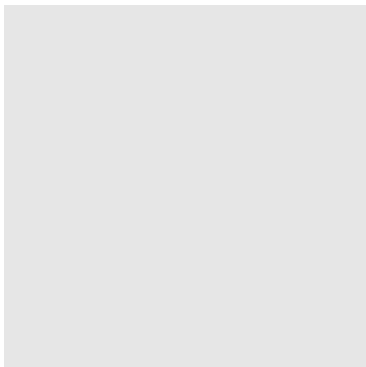

# PCB Parts

Wiring  
Ducts

Cable  
Markers

Cable  
Ties

Wrapping  
Bands

Cable Clamps  
& Tie Mounts

Glands,  
Bushings

Conduits

Bushings

Wire  
Connectors

Tubes

Cable  
Clips

**PCB  
Parts**

Fasteners



# 1101 KSS PCB SUPPORT

- Material: UL94V-2 flame rated, UL approved Nylon 66.
- Color: Natural
- Feature: Easy to install / unload by hand, without tool. Pre-drill a hole on P.C board and chassis before usage. Double locking design ensure that once install cannot be removed easily.

UNIT : mm

Item No.	H1	PCB		Chassis		Packing
		hole M1	thickness T1	hole M2	thickness T2	
CS-0305	4.8 (3/16")	4.0	1.8	4.8	2.5	100pcs
CS-0305S	4.8 (3/16")	3.0	2.0	3.0	2.0	
CS-0406	6.4 (1/4")	4.0	1.8	4.8	2.5	
CS-0406S	6.4 (1/4")	4.0	2.3	4.8	2.0	
CS-0610	9.3 (3/8")	4.0	1.8	4.8	2.5	
CS-0813	12.7 (1/2")	4.0	1.8	4.8	2.5	
CS-1016	15.9 (5/8")	4.0	1.8	4.8	2.5	
CS-1219	19.1 (3/4")	4.0	1.8	4.8	2.5	
CS-1422	22.2 (7/8")	4.0	1.8	4.8	2.5	
CS-1625	25.4 (1")	4.0	1.8	4.8	2.5	
CS-1828	28.5 (1 1/8")	4.0	1.8	4.8	2.5	
CS-2236	35 (1 3/8")	4.0	1.8	4.8	2.5	
CS-2236L	35 (1 3/8")	4.8	1.8	4.8	2.5	

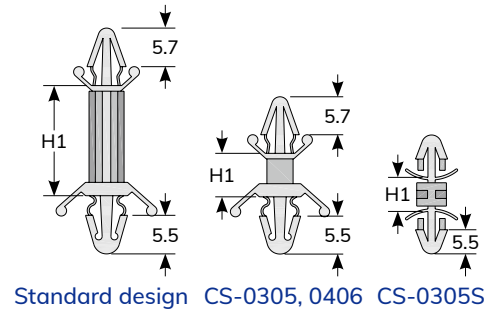

# 1101 KSS PCB SUPPORT

- Material: UL94V-2 flame rated, UL approved Nylon 66.
- Color: Natural

UNIT : mm

Item No.	H1	PCB		Chassis		Packing
		hole M1	thickness T1	hole M2	thickness T2	
CS-0305L	5.4	4.0	2.4	4.0	2.4	100pcs

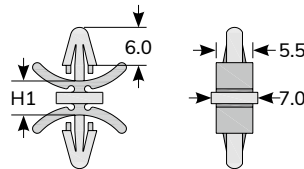

# 1101 KSS PCB SUPPORT

- Material: UL94V-2 flame rated, UL approved Nylon 66.
- Color: Natural

UNIT : mm

Item No.	H1	PCB		Chassis		Packing
		hole M1	thickness T1	hole M2	thickness T2	
MCS-6	6.0	4.0	1.8	4.8	2.0	100pcs
MCS-8	7.8	4.0	1.7	4.8	5.0	
MCS-9	9.4	4.0	1.6	4.8	2.0	
MCS-12	11.5	4.0	1.7	4.8	5.0	
MCS-19	19.0	4.0	2.0	4.8	2.0	

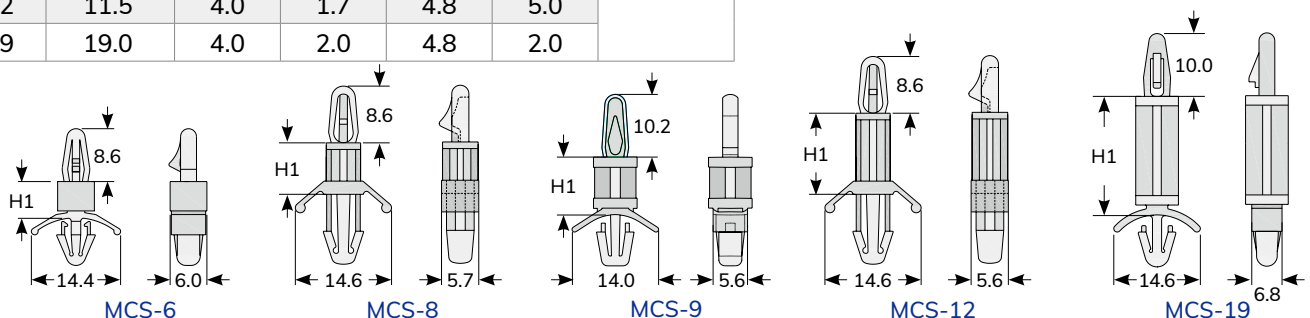

# 1102 KSS PCB SUPPORT



- Material: UL94V-2 flame rated, UL approved Nylon 66.
- Color: Natural
- Pre-drill a hole on P.C. board and chassis before usage. Easy to install / unload by hand, without tool.
- For application where space is limited and extra height is prohibited.

UNIT : mm

Item No.	H1	H2	PCB		Chassis		Packing
			hole M1	thickness T1	hole M2	thickness T2	
SP-3	3.2	3.8	4.0	1.6	4.0	1.6	100pcs
SP-3S	3.2	3.6	3.2	1.6	3.2	1.6	
SP-6	6.3	3.8	4.0	1.6	4.0	1.6	
SP-8	8.0	3.8	4.0	1.6	4.0	1.6	
SP-10	10.5	3.8	4.0	1.6	4.0	1.6	
SP-13	12.7	5.6	4.0	1.6	4.0	1.6	
SP-16	15.9	5.6	4.0	1.6	4.0	1.6	
SP-17	16.5	5.6	4.0	1.6	4.0	1.6	
SP-19	19.1	5.6	4.0	1.6	4.0	1.6	
SP-22	22.2	5.6	4.0	1.6	4.0	1.6	
SP-25	25.4	5.6	4.0	1.6	4.0	1.6	

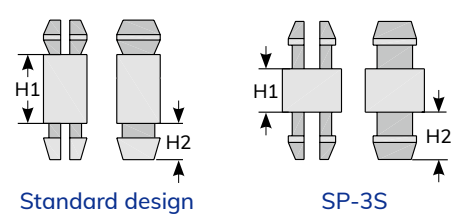

Wiring Ducts

Cable Markers

Cable Ties

Wrapping Bands

Cable Clamps & Tie Mounts

# 1102 KSS PCB SUPPORT



- Material: UL94V-2 flame rated, UL approved Nylon 66.
- Color: Natural

UNIT : mm

Item No.	H1	H2	PCB		Chassis		Packing
			hole M1	thickness T1	hole M2	thickness T2	
SPB-6	6.2	5.5	4.0	1.8	4.0	1.8	100pcs
SPC-9	9.3	4.0	4.0	1.6	4.0	1.6	
SPD-9	9.5	5.5	3.5	1.8	3.5	1.8	
SPB-20	20.0	5.5	4.0	1.8	4.0	1.8	
SPA-28	28.2	3.6	3.6	1.6	3.8	1.6	

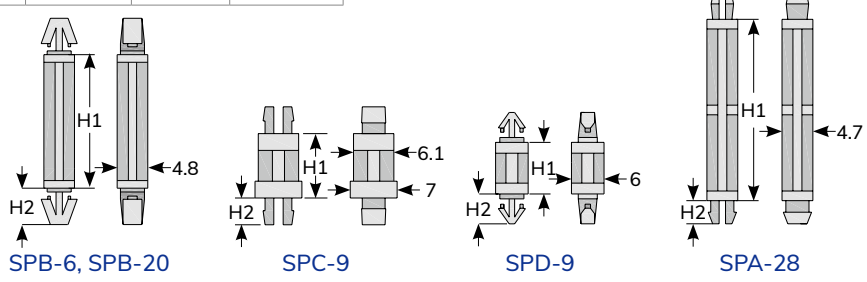

Glands, Bushings

Conduits

Bushings

Wire Connectors

Tubes

# 1102 KSS PCB SUPPORT



- Material: UL94V-2 flame rated, UL approved Nylon 66.
- Color: Natural

UNIT : mm

Item No.	H1	PCB		Chassis		Packing
		hole M1	thickness T1	hole M2	thickness T2	
LCA-14	13.6	2.5	2.0	3.0	1.7	100pcs

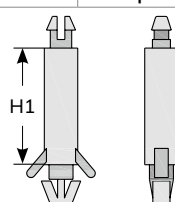

Cable Clips

PCB Parts

Fasteners

# 1102 KSS PCB SUPPORT

- Material: UL94V-2 flame rated, UL approved Nylon 66.
- Color: Natural

UNIT : mm

Item No.	H1	H2	PCB		Chassis		Packing
			hole M1	thickness T1	hole M2	thickness T2	
DS-18	18.2	3.7	2.5	1.6	2.5	1.5	100pcs

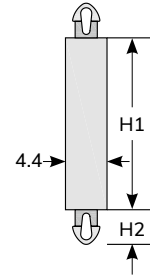

# 1103 KSS SCREW FASTENED PCB SUPPORT

- Material: UL94V-2 flame rated, UL approved Nylon 66.
- Color: Natural
- Pre-drill a hole on chassis, and fixed by #6 screw.

UNIT : mm

Item No.	H1	PCB		Chassis	Packing
		hole M1	thickness T1	hole M2	
CS-5	4.9	4.0	2.0	3.0	100pcs
CS-10	9.6				
CS-13	12.7				
CS-19	19.1				
CS-28	28.5				
CS-35	35.0				
CSA-14	13.9			2.5	

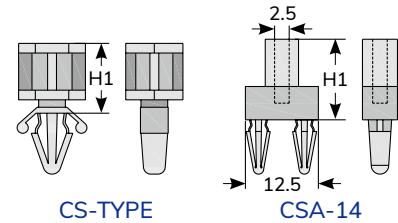

# 1104 KSS PCB SUPPORT

- Material: UL94V-2 flame rated, UL approved Nylon 66.
- Color: Natural

UNIT : mm

Item No.	H1	PCB		Packing
		hole M1	thickness T1	
RLS-5	5.0	5.5	1.8	100pcs
RLS-6	6.4			
RLS-8	8.0			
RLS-9	9.8			
RLS-10	10.1			
RLS-12	12.0			
RLS-14	14.0			
RLS-18	18.0			

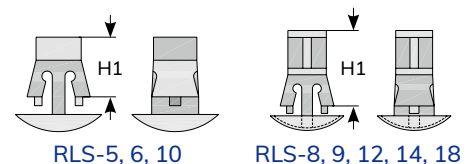



# 1104 KSS PCB SUPPORT

- Material: UL94V-2 flame rated, UL approved Nylon 66.
- Color: Natural
- Stand on design to lock Print circuit board.
- Easy to fix or remove from PC board by hand without tool.

UNIT : mm

Item No.	H1	PCB		Chassis		Packing
		hole M1	thickness T1	hole M2	thickness T2	
RS-2D	2.5	4.0	1.8	5.0	3.2	100pcs
RS-3	3.5	4.0	1.8	5.5	1.4	
RS-5	5.0	4.0	1.8	5.5	1.8	
RS-5D	5.0	4.0	1.8	5.0	3.2	
RS-5S	5.0	3.0	1.7	4.8	2.0	
RS-6	6.1	4.0	1.8	5.5	1.8	
RS-6A	5.6	4.0	1.6	6.4	1.8	
RS-6B	5.6	4.0	1.8	6.4	1.4	
RS-6C	6.1	4.2	1.8	5.2	1.4	
RS-6S	5.9	3.5	1.8	5.3	1.8	
RS-7A	6.6	4.0	1.6	5.4	1.6	
RS-8	8.0	4.0	1.8	5.5	1.8	
RS-8S	6.1	4.0	1.6	5.5	1.8	
RS-10	9.8	4.0	1.8	5.5	1.8	
RS-10S	9.3	4.0	1.6	5.5	1.8	
RS-10A	9.8	4.0	1.6	5.4	1.8	
RS-10L	9.8	4.0	1.6	5.5	1.8	
RS-12	12.0	4.0	1.8	5.5	1.8	
RS-12C	12.1	4.2	1.8	5.2	1.4	
RS-12H	11.8	4.0	1.6	5.5	1.8	
RS-14	14.0	4.0	1.8	5.5	1.8	
RS-18	18.0	4.0	1.8	5.5	1.8	

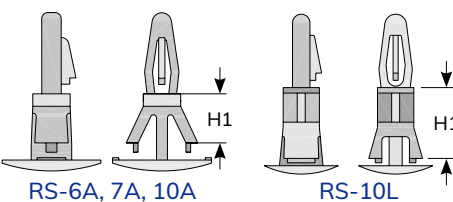
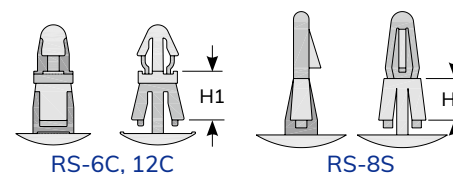
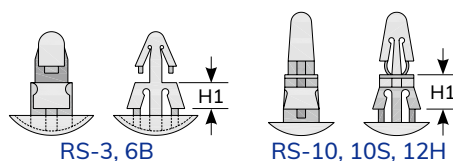
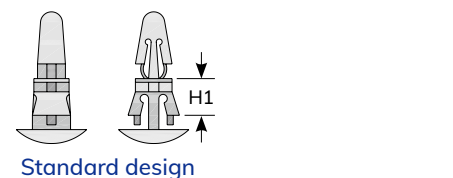

# 1105 KSS CIRCUIT BOARD EJECTOR

- Material: UL94V-2 flame rated, UL approved Nylon 66.
- Color: Natural
- Pre-drill 2.5-2.6mm hole on PC board and press the ejector directly into PC board.
- Suitable for PCB thickness 1.6mm

UNIT : mm

Item No.	Dimension	Packing
BE-1	As Figure	100pcs

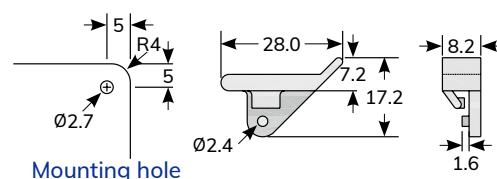

# 1106 KSS BLIND HOLD PCB SUPPORT

- Material: UL94V-2 flame rated, UL approved Nylon 66.
- Color: Natural

UNIT : mm

Item No.	H1	PCB		Mounting hole M2	Packing
		hole M1	thickness T1		
BCS-5	5.2	4.4	2.0	7.6	100pcs

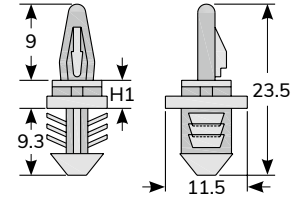

# 1106 KSS SCREW FASTENED PCB SUPPORT

- Material: UL94V-2 flame rated, UL approved Nylon 66.
- Color: Natural

UNIT : mm

Item No.	H1	PCB		Packing
		hole M1	thickness T1	
SCS-10	10.1	4.0	2.0	100pcs
SCS-25	25.4			

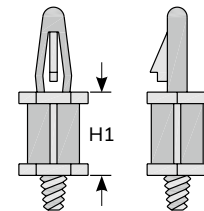

# 1107 KSS PUSH SPACER

- Material: UL94V-2 flame rated, UL approved Nylon 66.
- Color: Natural
- Pre-drill a hole on PC board and press push spacer into it.
- To support and stabilize PC board

UNIT : mm

Item No.	H1	PCB		Packing
		hole M1	thickness T1	
PS-5	4.8	4.8	2.0	100pcs
PS-6	6.4			
PS-10	9.6			
PS-13	12.7			
PS-16	15.9			
PS-19	19.1			
PS-22	22.2			
PS-25	25.4			
PS-28	28.5			
PS-36	35.0			

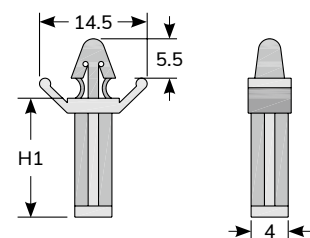

# 1108 KSS PCB SUPPORT



- Material: UL94V-2 flame rated, UL approved Nylon 66.
- Color: Natural

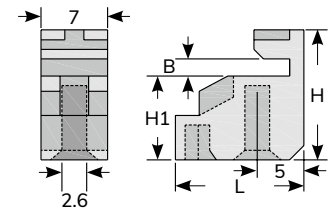

UNIT : mm

Item No.	L	H	H1	B	Packing
EB-9	13.5	13.6	8.7	1.8	100pcs

# 1108 KSS PCB EDGE SPACER



- Material: UL94V-2 flame rated, UL approved Nylon 66 with adhesive tape.
- Color: Natural
- To stabilize PC board, easy to remove.



UNIT : mm

Item No.	L1	W	H	H1	B	Packing
ES-5A	5.5	9.5	10.3	5.4	2.2	100pcs
ES-6A	9.0	8.7	10.8	6.0	1.9	
ES-6M	9.3	9.5	10.7	5.8	2.2	
ES-6P	9.0	8.7	10.8	6.0	1.9	
ES-6V	9.0	8.7	10.8	6.0	1.9	
ES-8U	6.7	9.8	13.3	8.4	2.0	

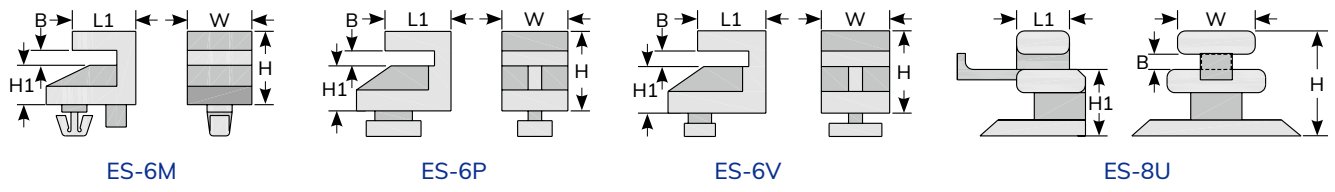
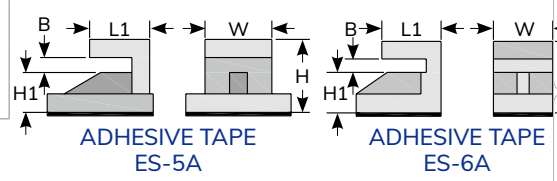

# 1109 KSS PCB SUPPORT



- Material: UL94V-2 flame rated, UL approved Nylon 66.
- Color: Natural
- Drill holes with size on chassis board as shown.
- Push support into larger hole then slide in smaller one to get fixed.
- To stabilize PC board, easy to remove.



UNIT : mm

Item No.	H1	PCB		Packing
		hole M1	thickness T1	
MS-6	6.4	4.0	2.0	100pcs

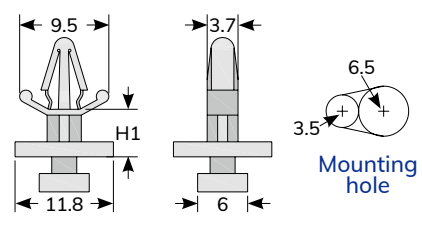

# 1109 KSS PCB SUPPORT

- Material: UL94V-2 flame rated, UL approved Nylon 66.
- Color: Natural, available in other colors.

UNIT : mm

Item No.	O.D.	H1	H2	PCB		Packing
				hole M1	thickness T1	
BMS-5	11.8	5.6	9.5	4.0	2.0	100pcs
BMS-5B	9.7	5.6	9.5	4.0		
BMS-5L7	7.1	5.6	9.5	4.8		
BMS-5L	11.8	5.6	9.5	4.8		
BMS-7	11.8	6.5	9.5	4.0		
BMS-8	11.8	8.0	9.5	4.0		
BMS-11	12.0	11.0	9.0	4.0		
HMS-6	7.0	6.0	5.0	4.8		

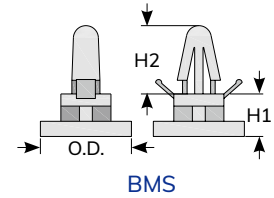

BMS

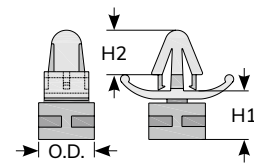

HMS-6

# 1109 KSS PCB SUPPORT

- Material: UL94V-2 flame rated, UL approved Nylon 66.
- Color: Natural, available in other colors.

UNIT : mm

Item No.	H1	PCB		Packing
		hole M1	thickness T1	
TMS-17	17.2	4.0	1.4	100pcs

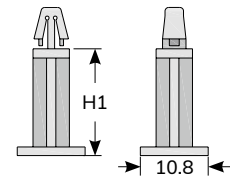

TMS-17

# 1109 KSS SELF-ADHESIVE PCB SUPPORT

- Material: UL94V-2 flame rated, UL approved Nylon 66 with adhesive tape.
- Color: Natural

UNIT : mm

Item No.	W	H1	PCB		Packing
			hole M1	thickness T1	
MMS-2	14.9	2.2	3.2	1.8	100pcs
MMS-21	17.9	21.3	4.0	1.8	

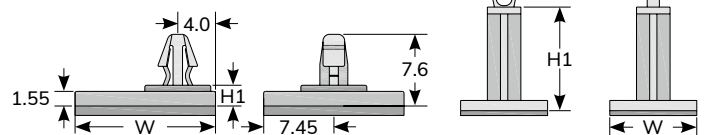

MMS-2

MMS-21

# 1109 KSS SELF-ADHESIVE PCB SUPPORT

- Material: UL94V-2 flame rated, UL approved Nylon 66 with adhesive tape.
- Color: Natural

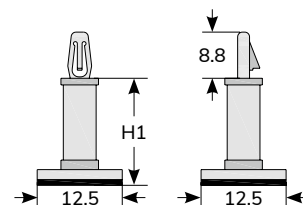

UNIT : mm

Item No.	H1	PCB		Packing
		hole M1	thickness T1	
MMR-5	4.8	3.2	1.6	100pcs
MMR-6	6.4			
MMR-8	7.9			
MMR-9	9.5			
MMR-11	11.1			
MMR-13	12.7			
MMR-14	14.3			
MMR-16	15.9			

Wiring Ducts

Cable Markers

Cable Ties

Wrapping Bands

Cable Clamps &amp; Tie Mounts

Glands, Bushings

Conduits

Bushings

Wire Connectors

Tubes

Cable Clips

PCB Parts

Fasteners

# 1110 KSS CIRCUIT BOARD TRACK

- Material: UL94V-2 flame rated, UL approved Nylon 66.
- Color: Natural, available in other colors.
- To be fixed by 2 sets of 3mm x 6mm flat-head screw.
- ★ BT-90A, BT-155A, BT-160A with snap in design.

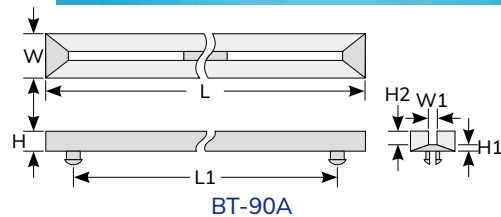

UNIT : mm

Item No.	L	L1	W	W1	H	H1	H2	Packing
BT-90A	89.5	77.6	9.7	2.0	4.5	1.5	3.0	100pcs
BT-90	89.5	64.4	9.7	2.0	4.5	1.5	3.0	
BT-120	120.0	95.5	9.5	2.0	4.5	1.5	3.0	
BT-140	141.0	115.4	10.0	1.9	4.5	1.5	3.0	
BT-155A	154.0	141.0	6.6	2.0	4.6	1.3	3.3	
BT-160	160.5	135.5	9.7	2.0	4.5	1.5	3.0	
BT-160A	162.0	148.2	9.6	2.0	6.5	4.0	2.5	
BT-77DBK	77.0	67.0	6.6	1.4	6.0	3.0	3.0	

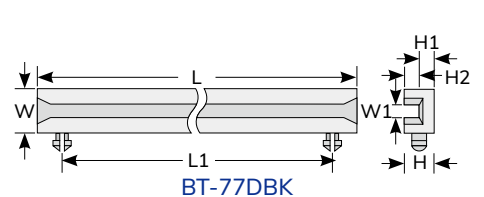
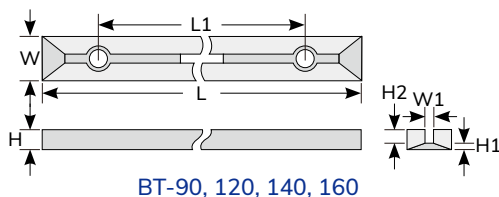
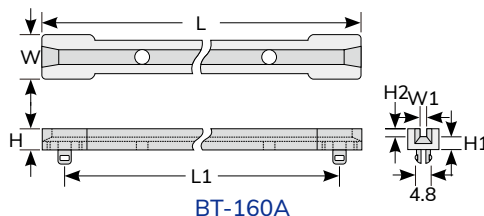
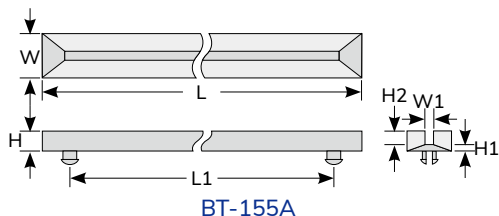

# 1111 KSS HEXAGONAL THREADED SPACER

- Material: UL94V-2 flame rated, UL approved Nylon 66.
- Color: Natural
- Application: Used screw and nut to set apart chassis board and PC board.
- Feature: can be extended by adding spacers.

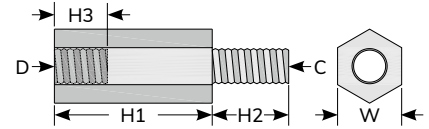

UNIT : mm

Item No.	W	H1	H2	H3	C/D	Packing
HTS-205	4.0	5	5	4.0	thread M2X0.4	100pcs
HTS-208	4.0	8	5	6.0		
HTS-210	4.0	10	5	6.0		
HTS-215	4.0	15	5	6.0		
HTS-306	5.6	6	6	5.3	thread M3X0.5	
HTS-308	5.6	8	6	7.5		
HTS-310	5.6	10	6	6.5		
HTS-312	5.6	12.7	6	10.0		
HTS-315	5.6	15	6	10.0		
HTS-317	5.6	17	6	10.0		
HTS-318	5.6	18	6	10.0		
HTS-320	5.6	20	6	10.0		
HTS-322	5.6	22	6	10.0		
HTS-325	5.6	25	6	10.0		
HTS-330	5.6	30	6	10.0	thread M4X0.7	
HTS-410	7.0	10.1	6	10.0		
HTS-413	7.0	13	6	7.0		
HTS-415	7.0	15	6	10.0		
HTS-419	7.0	19	6	10.0		
HTS-425	7.0	25	6	10.0		
HTS-430	7.0	30	6	10.0		

# 1113 KSS HEXAGONAL TAPPED SPACER

- Material: UL94V-2 flame rated, UL approved Nylon 66.
- Color: Natural
- Application: Used screw and nut to set apart chassis board and PC board.

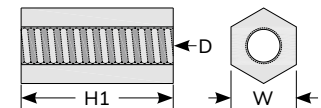

UNIT : mm

Item No.	W	H1	D	Packing
HTP-306	5.5	6.0	thread M3X0.5	100pcs
HTP-308	5.5	8.0		
HTP-310	5.5	10.0		
HTP-312S	5.5	12.1		
HTP-312	5.5	12.7		
HTP-315	5.5	15.0		
HTP-318	5.5	18.0		
HTP-320	5.5	20.0		
HTP-322	5.5	22.0		
HTP-325	5.5	25.0		
HTP-330	5.5	30.0		

# 1114 KSS HEXAGONAL SPACER



- Material: UL94V-2 flame rated, UL approved Nylon 66.
- Color: Natural
- ※ No inner thread



Item No.	W	H1	H2	I.D.	Packing
HTN-380	5.5	79	15	2.7	100pcs

UNIT : mm

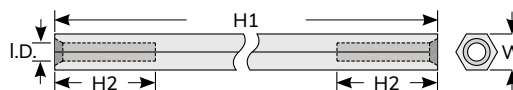

Wiring  
Ducts

Cable  
Markers

Cable  
Ties

Wrapping  
Bands

# 1115 KSS PCB SUPPORT



- Material: **UL94V-0** flame rated, UL approved Nylon 66.
- Color: White
- Function: To fix PC board.
- Feature: Easy to install by hand without tool.
- Application: Drill hole on chassis board and install spacer then fix on PC board.



Item No.	H1	PCB		Chassis		Packing
		hole M1	thickness T1	hole M2	thickness T2	
KCS-0813V0	12.5	4.0	2.5	4.8	2.5	100pcs

UNIT : mm

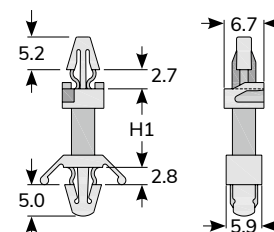

Cable Clamps  
& Tie Mounts

Glands,  
Bushings

Conduits

Bushings

Wire  
Connectors

# 1116 KSS PCB SUPPORT



- Material: UL94V-2 flame rated, UL approved Nylon 66.
- Color: Natural
- Function: To fix PC board.
- Application: Install on PC board one end and fix with screw in another end.



Item No.	H1	O.D.	I.D.	Suitable		Packing
				hole M1	thickness T1	
SPS-6	6.5	7.0	3.9	5.8	1.6	100pcs

UNIT : mm

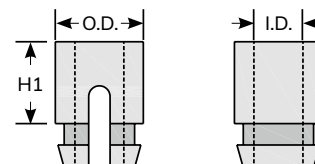

Tubes

Cable  
Clips

PCB  
Parts

Fasteners

# 1117 KSS PCB SUPPORT

- Material: UL94V-2 flame rated, UL approved Nylon 66.
- Color: Natural

UNIT : mm

Item No.	H	H1	Suitable		Packing
			hole M1	screw C	
PB-10	29.6	9.6	8.3 x 8.3	M4 x10mm	100pcs

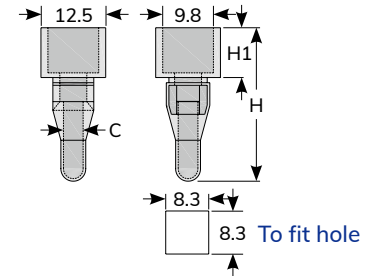

# 1118 KSS PCB SUPPORT

- Material: UL94V-2 flame rated, UL approved Nylon 66.
- Color: Natural

UNIT : mm

Item No.	H	H1	Suitable		Packing
			hole M1	screw C	
PST-18	25.8	19.0	7.6 x 7.6	#6-32UNC	100pcs

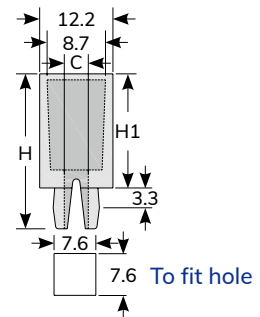

# 0723 KSS SQUARE HEAD GROMMET NUT

- Material: UL94V-2 flame rated, UL approved Nylon 66.
- Color: Natural

UNIT : mm

Item No.	H	H1	Suitable		Packing
			hole M1	thickness T1	
SGN-07	8.9	8.1	7X7.4	1.8	100pcs

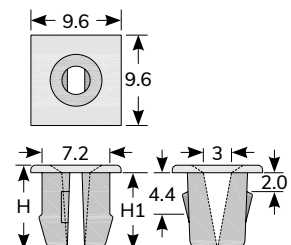



# 1119 KSS PCB SUPPORT

- Material: UL94V-2 flame rated, UL approved Nylon 66.
- Color: Natural
- Feature: Easy to install by hand without tool
- Application: Drill hole on chassis board and install spacer then fix on PC board.



UNIT : mm

Item No.	H1	Packing
HGS-7	7.0	100pcs
HGS-8	7.9	
HGS-11	7.0	

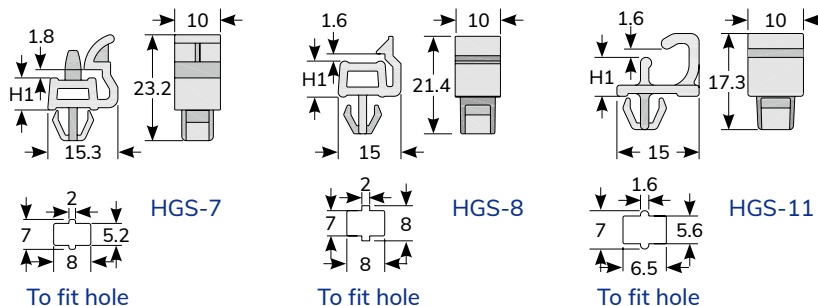

# 1120 KSS PCB SUPPORT

- Material: UL94V-2 flame rated, UL approved Nylon 66.
- Color: Natural



UNIT : mm

Item No.	H1	Packing
GS-10	10.0	100pcs

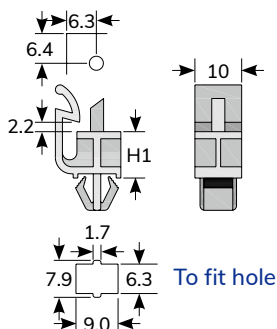

# 1120 KSS PCB SUPPORT

- Material: UL94V-2 flame rated, UL approved Nylon 66.
- Color: Natural



UNIT : mm

Item No.	H1	Packing
SWS-1	11.0	100pcs
SWS-2	10.0	

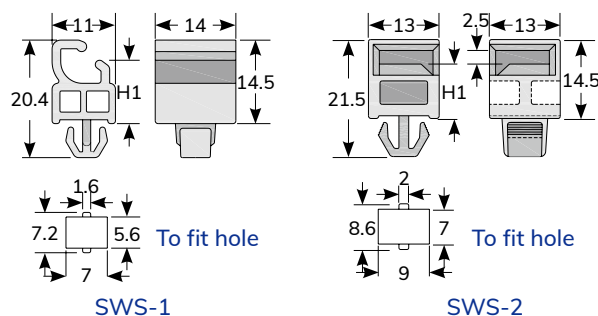

# 1121 KSS PCB SUPPORT

- Material: **UL94V-0** flame rated, UL approved Nylon 66.
- Color: White

UNIT : mm

Item No.	H1	PCB		Chassis		Packing
		hole M1	thickness T1	hole M2	thickness T2	
LCS-0610V0	9.4	4.0	2.0	4.8	2.0	100pcs

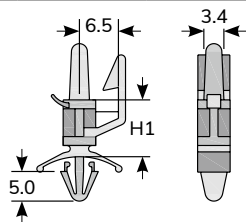

Wiring Ducts

Cable Markers

Cable Ties

Wrapping Bands

Cable Clamps & Tie Mounts

Glands, Bushings

Conduits

Bushings

Wire Connectors

Tubes

Cable Clips

PCB Parts

Fasteners

# 1121 KSS PCB SUPPORT

- Material: **UL94V-2** flame rated, UL approved Nylon 66.
- Color: Natural

UNIT : mm

Item No.	H1	PCB		Chassis		Packing
		hole M1	thickness T1	hole M2	thickness T2	
LCS-10A	9.0	4.0	1.8	4.0	1.8	100pcs

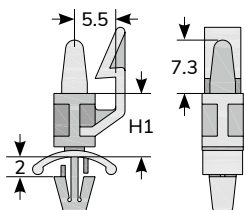

# 1121 KSS PCB SUPPORT

- Material: **UL94V-2** flame rated, UL approved Nylon 66.
- Color: White

UNIT : mm

Item No.	H1	Packing
LCL-8WE6	7.9	100pcs

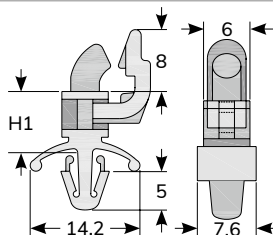

# 1123 KSS PCB SUPPORT

- Material: **UL94V-2** flame rated, UL approved Nylon 66.
- Color: Natural

UNIT : mm

Item No.	H1	PCB		Packing
		hole M1	thickness T1	
PCU-23	13.3	4.5	4.0	100pcs

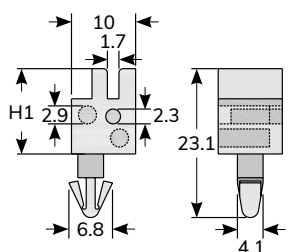

# 1125 KSS SNAP RIVET

- Material: UL94V-2 flame rated, UL approved Nylon 66.
- Color: Black, available in other colors.
- Function: To join chassis board and PC board.
- ※ With Male-and-female integrated design.

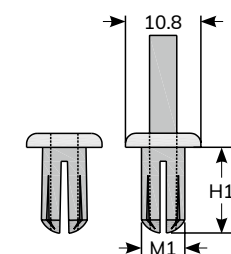
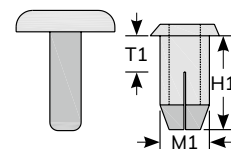

SR-0612 & SR-0815K

UNIT : mm

Item No.	H1	For		Packing
		Mounting Hole M1	Panel thickness T1	
SR-355K	5.5	3.0	2.5-4.0	1000pcs
SR-365K	6.5	3.0	4.0-5.0	
SR-380K	8.0	3.0	5.5-6.5	
SR-450K	5.0	4.0	2.2-3.5	
SR-465K	6.5	4.0	4.0-5.0	
※SR-0612K	12.3	6.4	7.0-10.0	
※SR-0815K	14.0	8.2	7.0-12.0	

# 1126 KSS SNAP RIVET

- Material: UL94V-2 flame rated, UL approved Nylon 66.
- Color: Black, available in other colors.
- Function: To join chassis board and PC board.

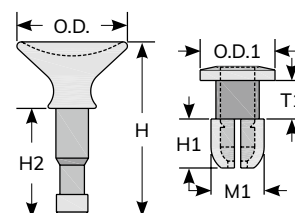

UNIT : mm

Item No.	H	H1	H2	O.D.	O.D.1	For		Packing
						Mounting Hole M1	Panel thickness T1	
SR-0813	25.1	7.0	15.6	15.8	10.7	7.8	5.5	100pcs
SR-0910	20.9	7.6	11.4	15.8	10.8	8.1	1.6	

# 1127 KSS SCREW ON RIVET



- Material: UL94V-2 flame rated, UL approved Nylon 66.
- Color: Black, available in other colors.
- Drill holes on chassis board and PC board, press in push rivet to fix two boards.
- Function: To join chassis board and PC board.

UNIT : mm



Item No.	H1	H2	O.D.	O.D.1	For		Packing
					Mounting Hole M1	Panel thickness T1	
SR-611	11.0	2.4	8.0	14.0	6.0	2~3.5	100pcs
SR-611R	11.0	1.4	8.4	16.0	6.6	1.5~6	
SR-614	14.2	1.95	10.2	15.1	6.3	3~4.5	

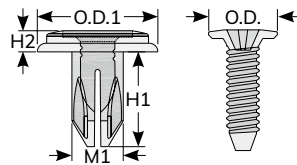

SR-611

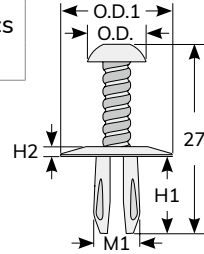

SR-611R

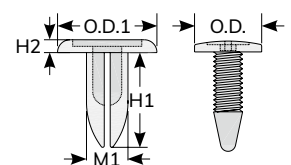

SR-614

# 1128 KSS PUSH RIVET



- Material: UL94V-2 flame rated, UL approved Nylon 66.
- Function: To join chassis board and PC board.

UNIT : mm



Item No.	Color	W	W1	H	H1	O.D.	Packing
SR-0313	Natural	3.2	3.2	14.9	12.9	6.3	100pcs
SR-0512BK	Black	5.1	4.7	13.6	12.5	11.2	
SR-1315	Natural	4.6	4.6	17.0	14.9	12.9	
SR-0816BK	Black	8.0	8.0	17.8	15.8	15.0	
SR-0817BK	Black	7.5	7.5	19.3	16.8	15.0	
SR-0420BK	Black	3.8	3.8	22.5	20.0	18.0	
SR-25BK	Black	6.6	6.6	27.2	25.2	17.85	

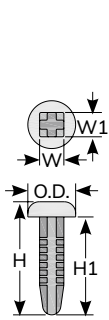

SR-0313

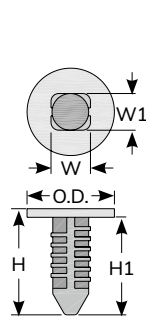

SR-0512BK

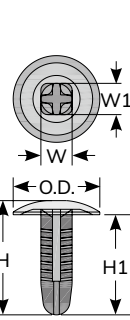

SR-1315

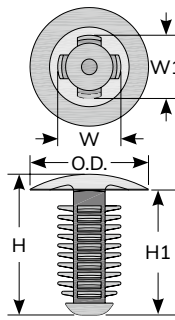

SR-0816BK

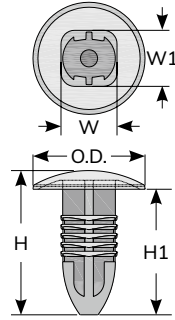

SR-0817BK

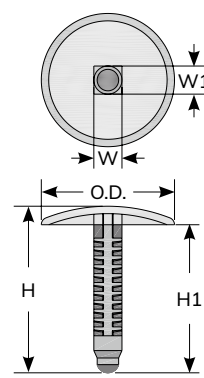

SR-0420BK

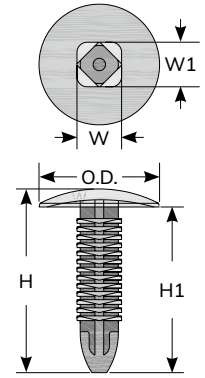

SR-25BK

# 1129 KSS SNAP RIVET



- Material: UL94V-2 flame rated, UL approved Nylon 66.
- Color: Natural
- Function: To join chassis board and PC board.

UNIT : mm



Item No.	H	H1	H2	O.D.	O.D.1	For		Packing
						Mounting Hole M1	Panel thickness T1	
SR-0809	13.6	7.4	11.1	7.1	8.5	6.3	1.9	100pcs
SR-0810	18.4	7.4	11.9	8.1	8.5	6.3	2.1	
SR-1010	19.1	7.8	12.9	9.2	10.8	8.0	2.6	

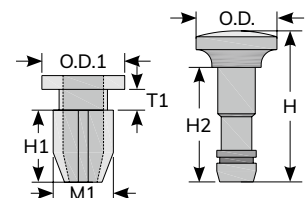

# 1130 KSS CANOE RIVET



- Material: UL94V-2 flame rated, UL approved Nylon 66.
- Color: Natural
- Function: To join chassis board and PC board.

UNIT : mm

Item No.	W	H1	O.D.	For		Packing
				Mounting Hole M1	Panel thickness T1	
SN-0309	3.8	8.7	7.4	3.3	3~6	100pcs
SN-0511	4.9	11.0	9.2	4.6	2~5	
SN-0716	7.5	16.0	12.9	7.2	3~6	

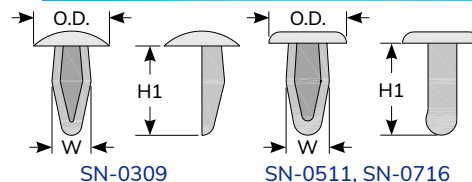

# 1131 KSS SNAP RIVET



- Material: UL94V-2 flame rated, UL approved Nylon 66.
- Color: Natural

UNIT : mm

Item No.	W	H1	O.D.	For		Packing
				Mounting Hole M1	Panel thickness T1	
SN-0305	4	5.2	5	3.2	5	100pcs

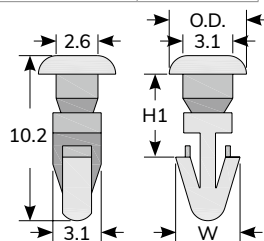

# 1132 KSS DRIVE RIVET



- Material: UL94V-2 flame rated, UL approved Nylon 66.
- Color: Natural
- Also available in material POM.

UNIT : mm

Item No.	W	H1	O.D.	For		Packing
				Mounting Hole M1	Panel thickness T1	
DN-0715	6.5	15	11	5.8	1~5.5	100pcs

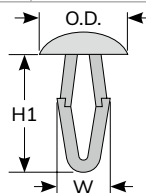

# 1136 KSS DOOR LOCK



- Material: UL94V-2 flame rated, UL approved Nylon 66.
- Color: Natural

UNIT : mm

Item No.	W1	W2	H	Packing
DR-1	8.2	10.6	14.7	100pcs

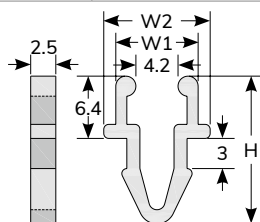

Wiring Ducts

Cable Markers

Cable Ties

Wrapping Bands

Cable Clamps & Tie Mounts

Glands, Bushings

Conduits

Bushings

Wire Connectors

Tubes

Cable Clips

PCB Parts

Fasteners

## 1140 KSS ROUND SPACER



- Material: PE
- Color: Natural

UNIT : mm

Item No.	H1	O.D.	I.D.	Packing
RSP-1607	6.9	19	16.5	100pcs

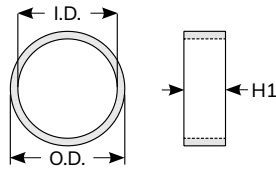

## 1141 KSS ROUND SPACER



- Material: UL94V-2 flame rated, UL approved Nylon 66.
- Color: Natural
- Function: To create space between chassis board and PC board.

UNIT : mm

Item No.	H1	O.D.	I.D.	Packing
RSP-0203	2.5	4.0	2.1	100pcs
RSP-0508	8.0	7.5	4.6	
RSP-0510	10.0	10.0	5.4	

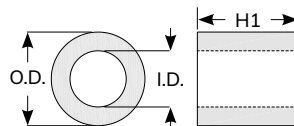

## 1141 KSS ROUND SPACER



- Material: UL94V-2 flame rated, UL approved Nylon 66.
- Color: Natural
- Function: To create space between chassis board and PC board.

UNIT : mm

Item No.	H1	O.D.	I.D.	Packing
RSC-0412	5	12.2	3.7	100pcs

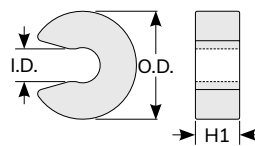

## 1151 KSS PCB HINGE



- Material: UL94V-2 flame rated, UL approved Nylon 66.
- Color: Natural

UNIT : mm

Item No.	H1	PCB		Packing
		hole	thickness	
PH-17	1.6	4	1.6	100pcs

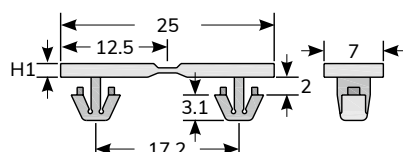

# Fasteners

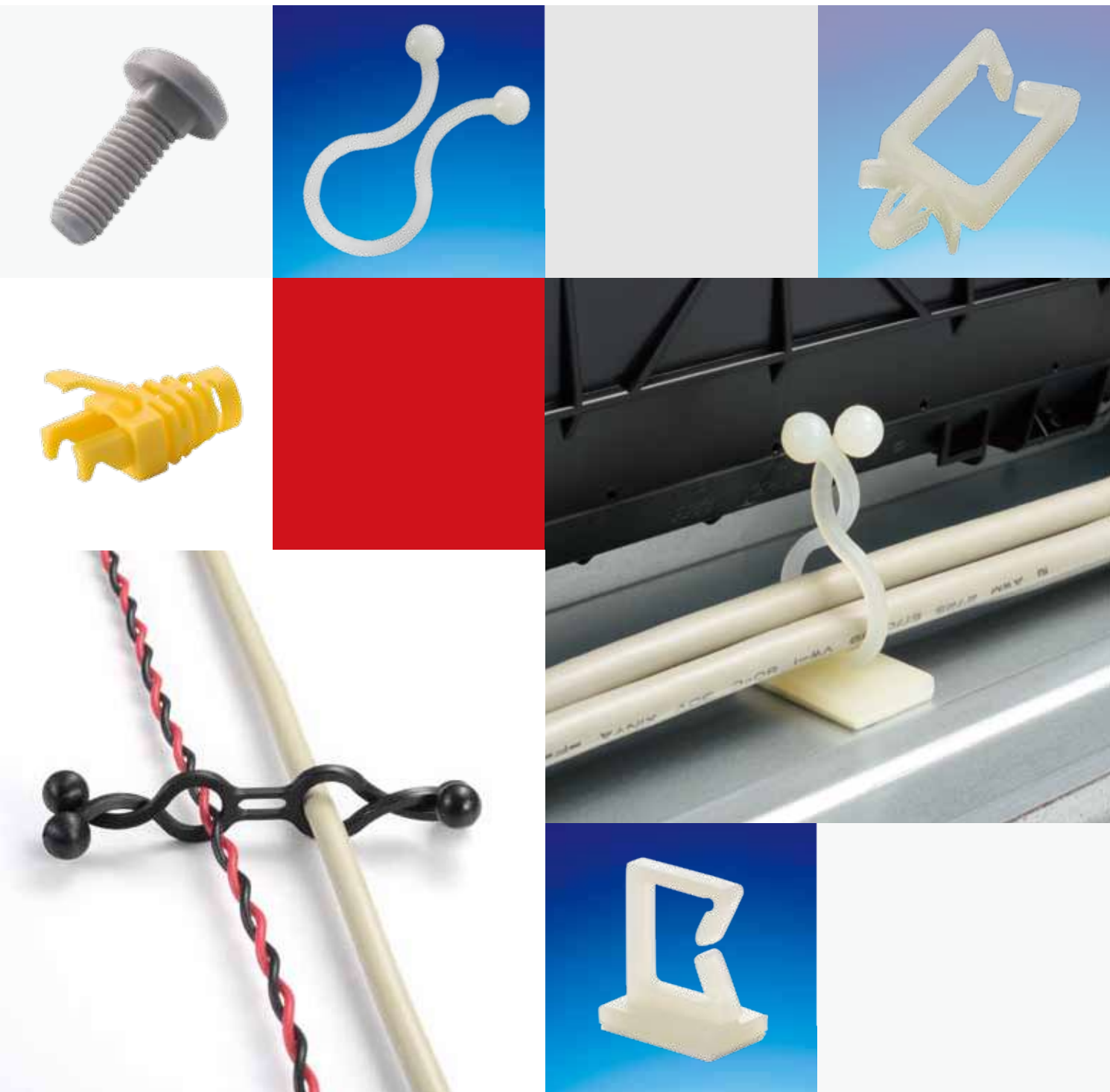

Wiring  
Ducts

Cable  
Markers

Cable  
Ties

Wrapping  
Bands

Cable Clamps  
& Tie Mounts

Glands,  
Bushings

Conduits

Bushings

Wire  
Connectors

Tubes

Cable  
Clips

PCB  
Parts

Fasteners

## 1201 KSS WIRE SADDLE



- Material: **UL94V-0** flame rated, UL approved Nylon 66.
- Color: White

UNIT : mm

Item No.	Dimension				Mounting Hole M1	Thickness T1	Packing
	L	W1	H1	H2			
JWS-0402V0	5.0	4.5	5.1	2.8	3.5	0.5~1.6	100pcs
JWS-0504V0	5.1	5.3	6.3	4.4	3.5	0.5~1.6	

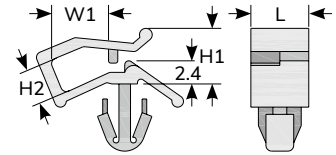

## 1201 KSS WIRE SADDLE



- Material: JWB-0706, JWS-0910 with **UL94V-2** flame rated, UL approved Nylon 66 Natural color.

UNIT : mm

Item No.	Dimension				Mounting Hole M1	Thickness T1	Packing
	L	W1	H1	H2			
JWB-0706	4.0	7.7	9.7	6.4	3.0	1.6	100pcs
JWS-0910	4.0	9.3	13.4	10.7	3.5	1.0	

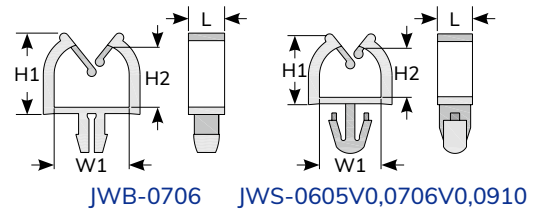

- Material: JWS-0605V0, JWS-0706V0 with **UL94V-0** flame rated, UL approved Nylon 66 White color.

UNIT : mm

Item No.	Dimension				Mounting Hole M1	Thickness T1	Packing
	L	W1	H1	H2			
JWS-0605V0	3.8	6.6	7.8	5.0	3.5	1.6	100pcs
JWS-0706V0	3.8	7.9	9.7	6.4	3.5	1.6	

## 1201 KSS LOCKING WIRE SADDLE



- Material: **UL94V-2** flame rated, UL approved Nylon 66.
- Color: Natural
- Application: Pre-drill 4.8mm hole PC board and fix the wire saddle, lock the wire in saddle with fingertip pressure. Can directing and gathering cable in any direction.

UNIT : mm

Item No.	Dimension				PCB		Packing
	W1	H1	H2	H3	Mounting Hole M1	Thickness T1	
KWS-0	11.0	13.0	4.0	9.0	4.8	2.0	100pcs
KWS-1	11.0	19.0	10.5	14.2	4.8	2.0	
KWS-2	11.0	27.0	19.0	23.0	4.8	2.0	
KWS-2L	10.4	18.0	12.0	15.0	4.8	4.0	
KWS-3	11.0	35.8	28.0	31.1	4.8	2.0	

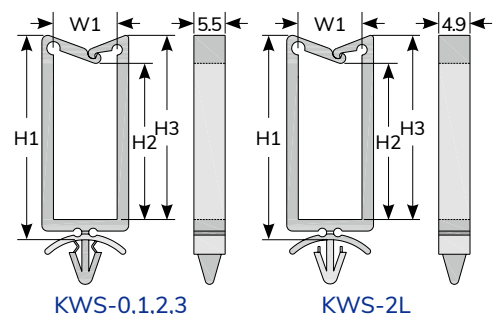



# 1201 KSS WIRE SADDLE



- Material: UL94V-2 flame rated, UL approved Nylon 66.
- Color: Natural
- Application: Pre-drill 4.8mm hole PC board and fix the wire saddle, lock the wire in saddle with fingertip pressure. Can directing and gathering cable in any direction.

UNIT : mm

Item No.	Dimension				PCB		Packing
	L	W1	H1	H2	Mounting Hole M1	Thickness T1	
PWS-1013	4.8	17.8	10.4	13.8	4.8	2.3	100pcs
PWS-1715	5.0	16.7	23.0	15.0	4.8	2.4	

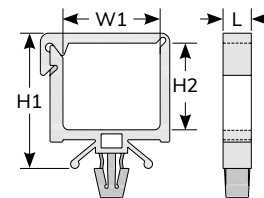

# 1201 KSS WIRE SADDLE



- Material: UL94V-2 flame rated, UL approved Nylon 66.
- Color: Natural

UNIT : mm

Item No.	Dimension			PCB		Packing
	W1	H1	H2	Mounting Hole M1	Thickness T1	
PWS-2824	27.6	35.3	24	4.8	2.0	100pcs

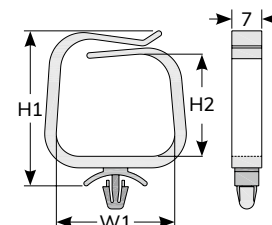

# 1202 KSS LOCKING WIRE SADDLE



- Material: UL94V-2 flame rated, UL approved Nylon 66.
- Color: Natural

UNIT : mm

Item No.	Dimension		PCB		Packing
	W1	H2	Mounting Hole M1	Thickness T1	
WS-1522	15.0	21.2	4.5	2.0	100pcs

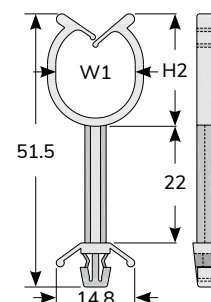

Wiring Ducts

Cable Markers

Cable Ties

Wrapping Bands

Cable Clamps & Tie Mounts

Glands, Bushings

Conduits

Bushings

Wire Connectors

Tubes

Cable Clips

PCB Parts

Fasteners

# 1202 KSS LOCKING WIRE SADDLE

- Material: UL94V-2 flame rated, UL approved Nylon 66.
- Color: Natural
- Application: Pre-drill 4.8mm hole PC board and fix the wire saddle, lock the wire in saddle with fingertip pressure. Can directing and gathering cable in any direction.



UNIT : mm

Item No.	Dimension				PCB		Packing
	W1	H	H1	H2	Mounting Hole M1	Thickness T1	
KWS-0N	11.0	12.7	9.2	4.0	4.8	2.0	100pcs
KWS-1N	11.0	17.9	14.8	9.6	4.8	2.0	
KWS-2N	11.3	26.7	23.4	18.4	4.8	2.0	
KWS-3N	11.0	34.8	31.3	26.2	4.8	2.0	
KWS-1114	10.7	21.2	17.8	13.7	4.8	2.4	

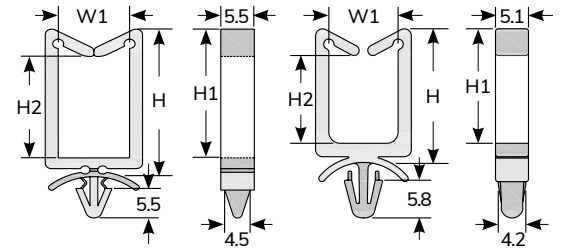

KWS-0N,1N,2N,3N

KWS-1114

# 1202 KSS LOCKING WIRE SADDL

- Material: UL94V-2 flame rated, UL approved Nylon 66.
- Color: Natural
- Application: Pre-drill hole on PC board and fix the wire saddle, lock the wire in saddle with fingertip pressure. Can directing and gathering cable in any direction.



UNIT : mm

Item No.	Dimension			PCB		Packing
	W	W1	H2	Mounting Hole M1	Thickness T1	
KWS-0506	9.0	5.0	5.4	4.8	3.0	100pcs
KWS-1106	13.0	10.5	5.4	4.8	1.6	
KWS-1110	14.4	10.9	9.8	As Figure	2.2	
KWS-1308	17.2	12.7	8.5	5.8	1.6	
KWS-1310	18.8	13.0	9.9	As Figure		
KWS-2314	28.3	22.9	13.6	4.8	3.4	

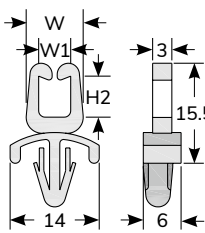

KWS-0506

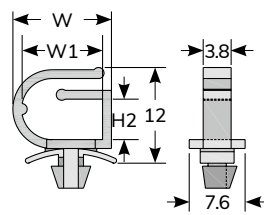

KWS-1106

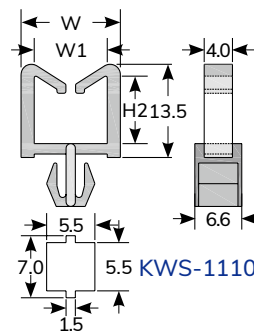

To fit hole

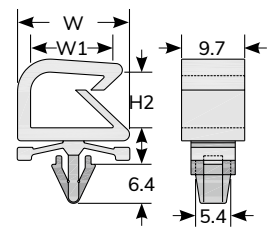

KWS-1308

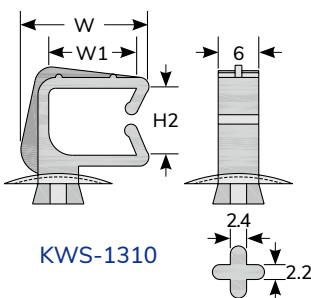

KWS-1310

To fit hole

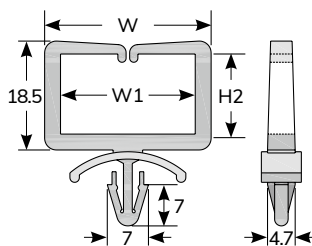

KWS-2314

# 1202 KSS EDGING WIRE SADDLE

- Material: UL94V-2 flame rated, UL approved Nylon 66.
- Color: Black

UNIT : mm

Item No.	Dimension							Packing
	W	W1	H	H2	A	B	C	
HL-1109	18.5	11.1	40.0	8.8	15.6	14.0	12.3	100pcs
HL-1817	25.4	18.0	56.8	16.8	23.5	21.0	21.0	

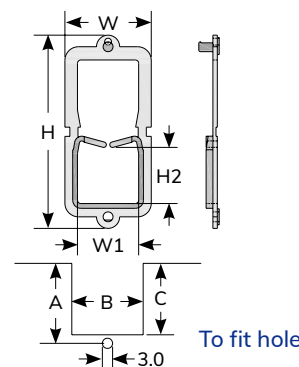

Wiring Ducts

Cable Markers

Cable Ties

Wrapping Bands

Cable Clamps & Tie Mounts

# 1202 KSS EDGING WIRE SADDLE

- Material: UL94V-2 flame rated, UL approved Nylon 66.
- Color: Natural

UNIT : mm

Item No.	W1	H2	Packing
ES-16	16.4	9.3	100pcs

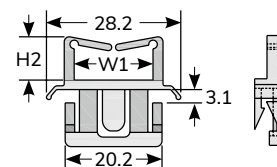

Glands, Bushings

Conduits

Bushings

Wire Connectors

# 1202 KSS EDGING WIRE SADDLE

- Material: **UL94V-0** flame rated, UL approved Nylon 66.
- Color: White

UNIT : mm

Item No.	Dimension				Packing
	W	W1	H1	H2	
ES-1207V0	19.3	11.8	12.3	7.3	100pcs

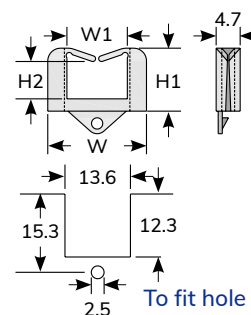

Tubes

Cable Clips

PCB Parts

Fasteners

# 1202 KSS WIRE SADDLE



- Material: UL94V-2 flame rated, UL approved Nylon 66.
- Color: Natural

UNIT : mm

Item No.	Dimension			Mounting Hole M1	Min Depth T1	Packing
	W1	H1	H2			
BWS-1106	11.1	13.0	5.0	7.8	8.7	100pcs
BWS-1112	11.1	18.3	10.3			
BWS-1120	11.1	27.2	19.2			
BWS-1128	11.1	35.6	27.8			

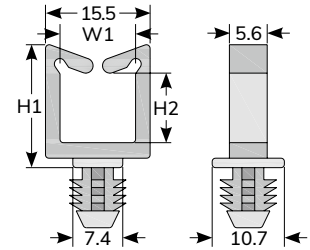

# 1203 KSS N TYPE WIRE SADDLE



- Material: UL94V-2 flame rated, UL approved Nylon 66.
- Color: Natural
- Pre-drill 5.6mm hole on board and install the wire saddle. Open gate to insert cable, release to close.

UNIT : mm

Item No.	Dimension			Packing
	W1	H1	H2	
PCC-1	10.6	10.7	6.3	100pcs

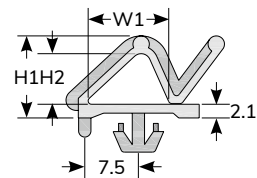

# 1204 KSS WIRE SADDLE



- Material: UL94V-2 flame rated, UL approved Nylon 66.
- Color: Natural

UNIT : mm

Item No.	Dimension					Packing
	W1	W2	W3	H2	H3	
TWS-3	16.3	24.8	27	8.4	8.8	100pcs

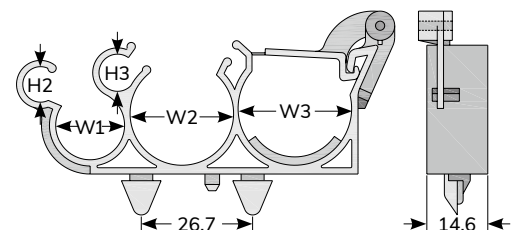

Wiring Ducts

Cable Markers

Cable Ties

Wrapping Bands

Cable Clamps & Tie Mounts

Glands, Bushings

Conduits

Bushings

Wire Connectors

Tubes

Cable Clips

PCB Parts

Fasteners

# 1204 KSS WIRE SADDLE



- Material: UL94V-2 flame rated, UL approved Nylon 66.
- Color: Natural

UNIT : mm

Item No.	Dimension		PCB		Packing
	W1	H1	Mounting Hole M1	Thickness T1	
RH-5	5.1	8.0	5.5	2.0	100pcs
RH-6	6.2	9.5	8.0	1.8	
RH-8	7.5	11.5	6.2	2.0	
RH-9	9.6	18.0	9.5	2.0	

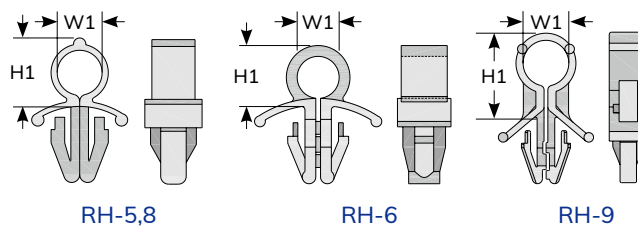

# 1204 KSS WIRE SADDLE



- Material: UL94V-2 flame rated, UL approved Nylon 66.
- Color: Natural

UNIT : mm

Item No.	Dimension H2	PCB		Packing
		Mounting Hole M1	Thickness T1	
RWS-6	6.2	6.0	2.0	100pcs
RWS-7	7.0	7.8	2.0	

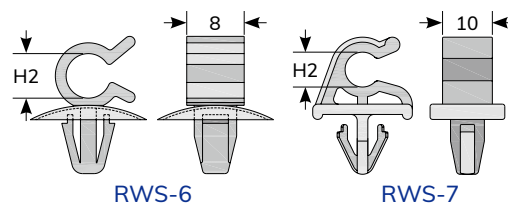

# 1204 KSS DOUBLE ROUTING CLIP



- Material: UL94V-2 flame rated, UL approved Nylon 66.
- Color: Natural

UNIT : mm

Item No.	W1	H1	PCB		Packing
			Mounting Hole M1	Thickness T1	
DR-6	6.2	7.7	3.2	2.0	100pcs

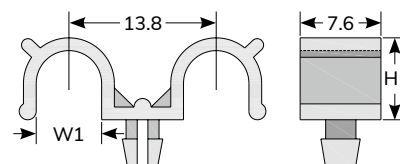

# 1204 KSS WIRE SADDLE

- Material: UL94V-2 flame rated, UL approved Nylon 66.
- Color: Natural

UNIT : mm

Item No.	H1	H2	PCB		Packing
			Mounting Hole M1	Thickness T1	
LWS-5	7.8	5.4	4.0	2.4	100pcs

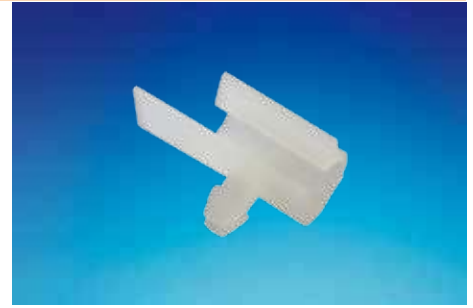
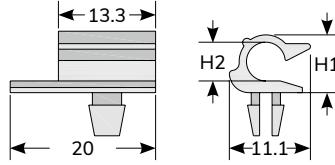

# 1205 KSS CLIP TWIST TIE

- Material: UL94V-2 flame rated, UL approved Nylon 66.
- Color: Natural

UNIT : mm

Item No.	Dimension			Packing
	W1	H1	H2	
CTT-17	16.7	4.2	30.5	100pcs

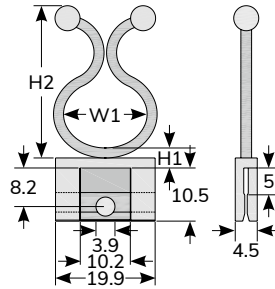

# 1205 KSS STANDOFF TWIST TIE

- Material: UL94V-2 flame rated, UL approved Nylon 66.
- Color: Natural
- Locking into pre-drilled hole, Insert cables and twist on to fix.

UNIT : mm

Item No.	Dimension			Mounting Hole M1	Thickness T1	Packing
	W1	H1	H2			
ST-1	6.0	31.7	19.5	4.6~4.8	1.0~2.8	100pcs
ST-2	11.0	21.2	27.8	4.8~5.0	1.0~2.8	
ST-3	10.4	4.7	27.3	4.6~4.8	1.0~2.8	
ST-3B	11.0	5.0	28.0	6.2~6.6	0.5~2.0	
ST-3C	15.0	5.0	32.0	4.6~4.8	0.5~1.6	
ST-3D	18.0	5.3	36.2	4.4~4.8	1.0~2.4	
ST-4S	11.0	13.0	27.9	4.2~4.8	1.0~2.4	
ST-4	15.0	13.1	31.3	4.6~4.8	1.0~2.0	
ST-0560	5.0	60.9	20.5	4.6~5.0	1.6~3.0	
ST-0605	6.1	5.3	19.3	4.0~4.4	2.4	
ST-0701	7.0	1.3	22.0	4.6~4.8	1.0~2.8	
ST-1112	11.0	15.3	26.8	4.6~4.8	1.6~3.0	
ST-1247	11.0	50.5	27.2	4.6~4.8	1.6~3.0	
ST-1303	13.5	3.0	45.0	6.6	1.8~3.6	
ST-1602	16.0	5.1	31.7	4.4~4.6	0.5~1.6	
ST-2005	20.0	5.1	36.5	7.2~7.6	1.8~3.6	
ST-2403	23.5	3.2	44.2	4.8~5.0	0.5~2.6	

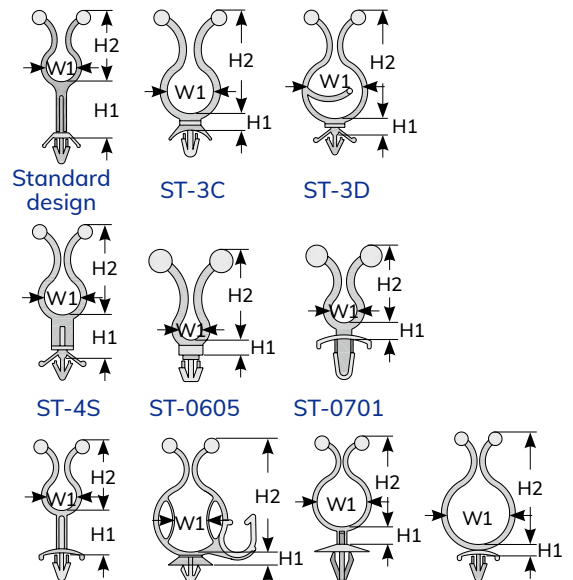

ST-1112,1247 ST-1303 ST-2005 ST-2403

# 1209 KSS WIRE SADDLE



- Material: UL94V-2 flame rated, UL approved Nylon 66.
- Color: Natural

UNIT : mm

Item No.	Dimension				PCB		Packing
	W1	H1	H2	H3	Mounting Hole M1	Thickness T1	
RCS-4	2.2	4.0	2.7	5.0	4.0	2.4	100pcs

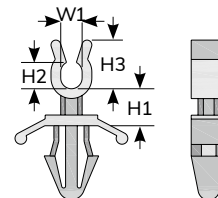

Wiring Ducts

Cable Markers

Cable Ties

Wrapping Bands

# 1210 KSS PURSE LOCK TWIST TIE



- Material: UL94V-2 flame rated, UL approved Nylon 66.
- Color: Black

UNIT : mm

Item No.	Dimension		Packing
	W1	H1	
PL-8	8.0	18	100pcs
PL-0740	7.5	40	

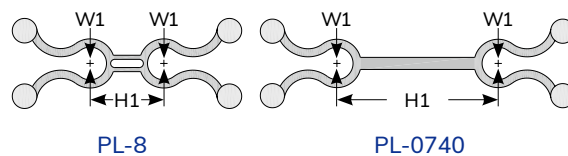

Cable Clamps & Tie Mounts

Glands, Bushings

Conduits

Bushings

# 1212 KSS TWIST TIE



- Material: UL94V-2 flame rated, UL approved Nylon 66.
- Color: Natural
- Colors available upon request.
- Tie-up cables at economical cost.
- Insert cables and twist on to fix.

UNIT : mm

Item No.	Dimension			Bundle Diameter	Packing
	L	W1	H		
TT-05	1.5	5.1	21.6	4.4	100pcs
TT-08	2.0	8.0	25.0	7.0	
TT-11	1.7	11.6	29.8	10.1	
TT-15	1.9	15.0	33.8	13.4	
TT-18	1.9	18.6	40.0	16.2	
TT-24	2.0	23.6	45.0	21.3	
TTU-05	1.8	5.0	22.0	4.2	
TTU-08	2.3	8.1	26.2	7.2	
TTU-11	2.3	11.3	29.7	10.0	
TTU-15	2.0	14.8	32.6	13.2	
TTU-18	2.0	18.0	38.0	16.5	
TTU-22	2.0	22.0	42.3	19.8	
TTU-28	2.0	28.0	55.1	26.7	

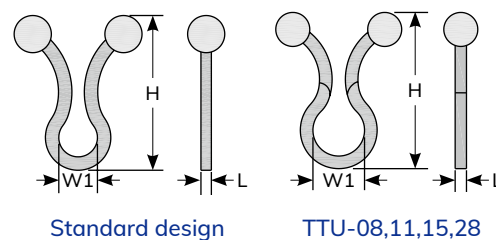

Wire Connectors

Tubes

Cable Clips

PCB Parts

Fasteners

## 1215 KSS MOUNTING TWIST TIE



- Material: UL94V-2 flame rated, UL approved Nylon 66 with adhesive tape.
- Color: Natural.
- Peel off adhesive paper before usage, insert cables and twist on to fix.



UNIT : mm

Item No.	W	W1	H	Bundle Diameter	Packing
TTB-08	17.4	7.9	27.5	7~10	100pcs
TTB-15	22.0	14.8	35.2	10~15	
TTB-20	25.5	20.6	40.0	15~20	

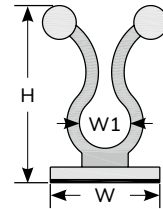

## 1216 KSS ADHESIVE WIRE SADDLE



- Material: UL94V-2 flame rated, UL approved Nylon 66 with adhesive tape.
- Color: Natural.



UNIT : mm

Item No.	L	W	W1	H2	Packing
AWS-11	19.8	20.0	11.2	11.0	100pcs
AWS-9R	16.0	29.8	8.5	13.6	
AWS-1210	18.3	20.7	11.3	10.0	
AWS-0912	9.5	15.8	9.0	11.6	

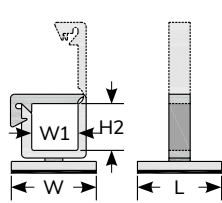

AWS-11

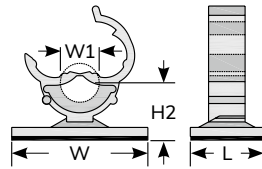

AWS-9R

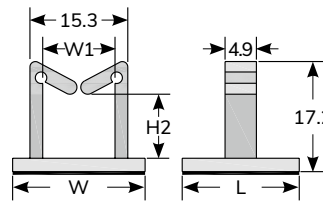

AWS-1210

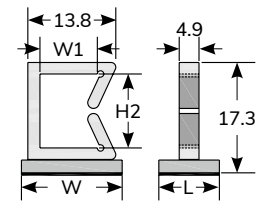

AWS-0912

## 1217 KSS SPACERS RING



- Material: UL94V-0 flame rated, UL approved Nylon 66.
- Color: White.



UNIT : mm

Item No.	H1	H2	O.D.	Packing
SPR-8V0	14.2		28.0	100pcs
SPR-45V0	26.3	22	49.2	

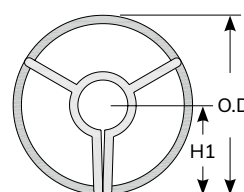

SPR-8V0

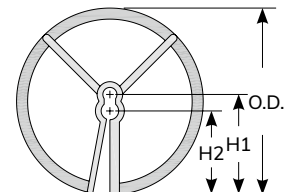

SPR-45V0



## 1301 KSS TRANSISTOR HOUSING



- Material: **UL94V-0** flame rated, UL approved Nylon 66.
- Color: Black.
- To protect transistors from electric short circuit and good for thermal control.

UNIT : mm

Item No.	Dimension	Packing
TH-1V0	As Figure	100pcs

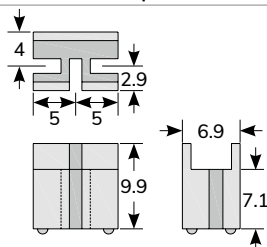

## 1301 KSS TRANSISTOR HOUSING



- Material: **UL94V-2** flame rated, UL approved Nylon 66.
- Color: Natural.

UNIT : mm

Item No.	L	W	W1	H	Packing
THR-2	4.0	10.1	2.8	5.0	100pcs

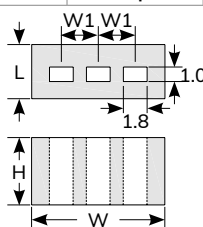

## 1302 KSS TRANSISTOR COVER



- Material: **UL94V-0** flame rated, UL approved Nylon 66.
- Color: White.
- To protect transistor legs from short circuit or breaking.

UNIT : mm

Item No.	Dimension	Packing
TH-2V0	As Figure	100pcs
TH-3V0		

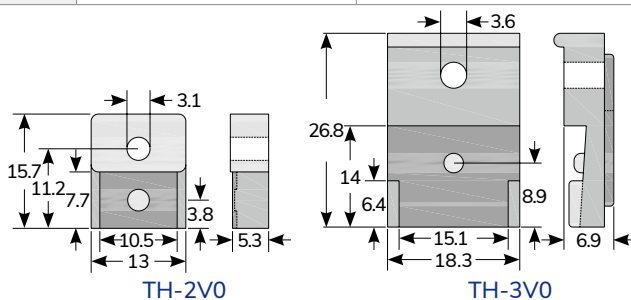

## 1302 KSS NTC THERMISTOR HOUSING



- Material: **UL94V-0** flame rated, UL approved Nylon 66.
- Color: White.

UNIT : mm

Item No.	L	W	H	Packing
TRH-7V0	5.1	7.5	16.5	100pcs

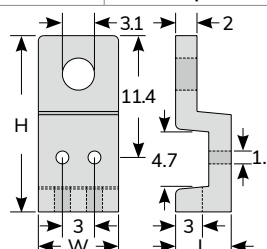

# 1303 KSS TRANSISTOR HOUSING



- Material: UL94V-2 flame rated, UL approved Nylon 66.
- Color: Natural.

UNIT : mm

Item No.	H1	H2	Packing
TR-3	1.1	2.1	100pcs

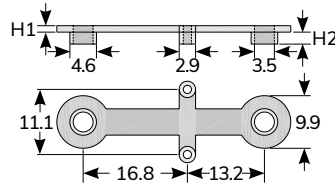

Wiring Ducts

Cable Markers

Cable Ties

# 1305 KSS WASHER



- Material: UL94V-2 flame rated, UL approved Nylon 66.
- Color: Natural.

UNIT : mm

Item No.	H	O.D.	I.D.	Packing
WR-3207	1.5	31.7	7	100pcs

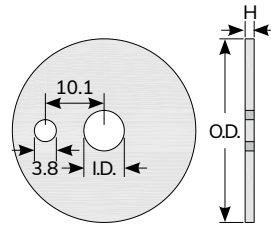

Wrapping Bands

Cable Clamps & Tie Mounts

Glands, Bushings

# 1306 KSS WASHER



- Material: UL94V-2 flame rated, UL approved Nylon 66.
- Color: Natural.
- ※ WR-2011RU Material: TPE (Thermoplastic Elastomer) (Black)

UNIT : mm

Item No.	H	O.D.	I.D.	Packing
WR-0503	0.8	4.5	2.5	100pcs
WR-0603	0.8	6.0	3.0	
WR-0803	1.0	8.0	3.2	
WR-0904	0.8	9.0	4.3	
WR-1005	1.0	10.0	5.3	
WR-1206	1.5	12.0	6.4	
WR-1208	1.5	12.0	8.0	
※WR-2011RU	2.0	20.0	10.6	

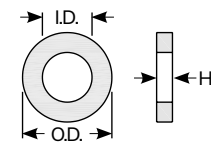

Conduits

Bushings

Wire Connectors

Tubes

# 1307 KSS HEADBOARD WASHER



- Material: PE.
- Color: Natural.

UNIT : mm

Item No.	H	O.D.	I.D.	I.D.1	Packing
HBW-1808	11.7	36.7	8.6	18	100pcs

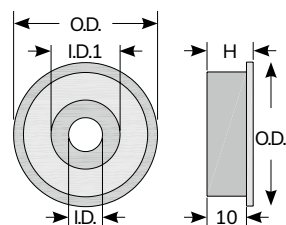

Cable Clips

PCB Parts

Fasteners

## 1308 KSS ROUND WASHER

- Material: UL94V-2 flame rated, UL approved Nylon 66.
- Color: Natural.

UNIT : mm

Item No.	H	H1	O.D.	I.D.	I.D.1	Packing
RW-45	4.5	3.1	8.0	4.0	6.5	100pcs

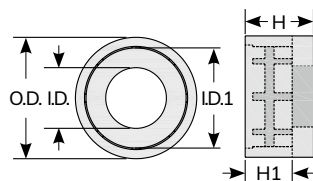

Wiring  
Ducts

Cable  
Markers

Cable  
Ties

## 1308 KSS CONOID WASHER

- Material: UL94V-2 flame rated, UL approved Nylon 66.
- Color: Natural.

UNIT : mm

Item No.	H	H1	O.D.	I.D.	I.D.1	I.D.2	Packing
CDW-12	12.2	10.7	10	3.3	8.3	6.9	100pcs

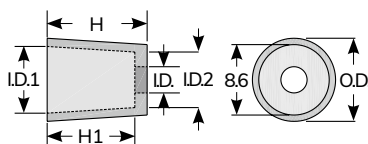

Wrapping  
Bands

Cable Clamps  
& Tie Mounts

Glands,  
Bushings

## 1310 KSS TRANSISTOR WASHER

- Material: UL94V-2 flame rated, UL approved Nylon 66.
- Color: Natural.
- ※ TW-123ABK Black color.

UNIT : mm

Item No.	H	H1	O.D.	O.D.1	I.D.	Packing
TW-63A	0.5	8.1	6.0	3.5	2.8	100pcs
TW-63B	1.2	1.4	6.0	3.5	2.9	
TW-63C	1.7	2.3	6.0	3.5	2.9	
TW-63D	1.9	3.2	6.0	3.5	2.9	
TW-63E	2.0	2.6	6.1	3.5	2.9	
TW-63F	1.3	2.0	6.3	3.4	2.9	
TW-73A	3.0	1.8	6.6	4.2	3.2	
TW-73B	1.3	2.5	6.9	3.6	2.9	
TW-83A	1.3	3.7	7.7	5.8	3.1	
TW-83B	1.2	5.6	7.8	3.6	2.9	
TW-83C	2.0	0.9	7.8	4.3	3.2	
TW-83D	1.3	2.3	8.0	3.5	2.9	
TW-83E	3.7	1.2	7.8	5.9	3.2	
TW-123ABK (Black)	0.5	3.0	12.0	5.9	3.2	
TW-133A	1.5	1.7	12.7	7.9	3.7	
TW-163A	1.5	2.0	16.0	6.0	3.2	
TW-189A	3.3	1.5	18.0	12.4	9.3	

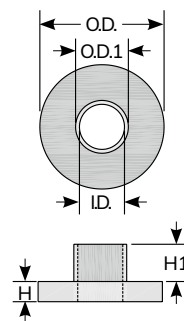

Conduits

Bushings

Wire  
Connectors

Tubes

Cable  
Clips

PCB  
Parts

Fasteners

# 1311 KSS TRANSISTOR WASHER

- Material: UL94V-2 flame rated, UL approved Nylon 66.
- Color: Natural.

UNIT : mm

Item No.	Dimension		Packing
	H	O.D.	
TRW-3	3.0	5.7	100pcs
TRW-5	4.6	8.9	

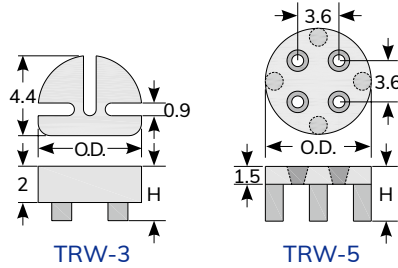

# 1321 KSS LED HOLDER

- Material: UL94V-2 flame rated, UL approved Nylon 66.
- Color: Natural.

UNIT : mm

Item No.	Dimension					Packing
	L	W	W1	H	I.D.	
LE-3	3.6	7.2	3.6	3.1	1.2	100pcs
LE-6	3.6	7.1	3.9	6.0	1.2	
LE-13	4.0	6.0	3.9	12.9	1.4	

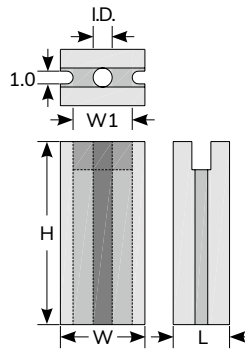

# 1322 KSS LED HOLDER

- Material: UL94V-2 flame rated, UL approved Nylon 66.
- Color: Natural.

UNIT : mm

Item No.	Dimension H	Packing
LK-5	5	100pcs
LK-18	18	

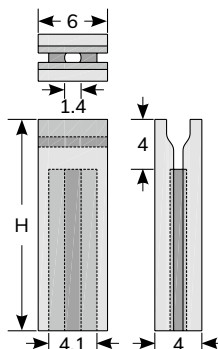
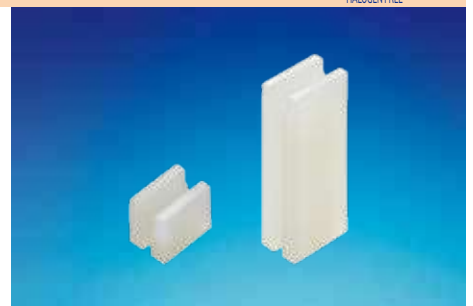

# 1327 KSS LED HOLDER

- Material: UL94V-2 flame rated, UL approved Nylon 66.
- Color: Natural.

UNIT : mm

Item No.	Dimension		Packing
	W	H	
LX-3	5	3	100pcs
LX-6	5	6	
LX-12	5	12	

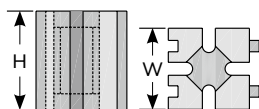

Wiring Ducts

Cable Markers

Cable Ties

# 1328 KSS LED HOLDER

- Material: UL94V-2 flame rated, UL approved Nylon 66.
- Color: Natural.

UNIT : mm

Item No.	Dimension		Packing
	H1	H2	
LQT-3	3.1	6.6	100pcs

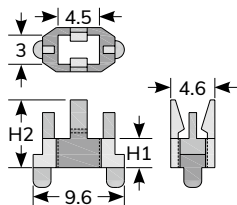

Wrapping Bands

Cable Clamps & Tie Mounts

Glands, Bushings

# 1329 KSS LED HOLDER

- Material: UL94V-2 flame rated, UL approved Nylon 66.
- Color: Natural.

UNIT : mm

Item No.	Dimension	Packing
	H1	
LQ-2	2.6	100pcs

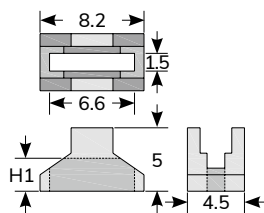

Conduits

Bushings

Wire Connectors

# 1331 KSS LED HOLDER

- Material: UL94V-2 flame rated, UL approved Nylon 66.
- Color: Natural.

UNIT : mm

Item No.	Dimension		Packing
	H	O.D.	
LDT-17	17.2	5.7	100pcs

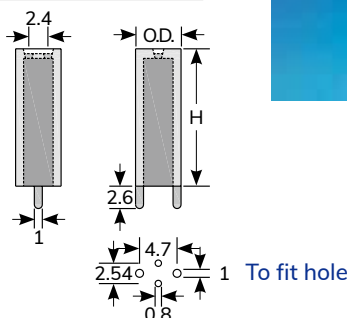

Tubes

Cable Clips

PCB Parts

Fasteners

# 1332 KSS LED HOLDER

- Material: UL94V-2 flame rated, UL approved Nylon 66.
- Color: Natural.

UNIT : mm

Item No.	Dimension		Packing
	H	LED	
LD3-6	6.1	3Ø2PIN	100pcs
LD3-9	9.0		
LD3-12	12.0		
LD3-16	16.0		
LD3-19	19.0		

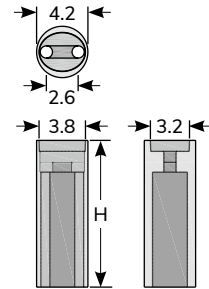

# 1333 KSS LED HOLDER

- Material: UL94V-2 flame rated, UL approved Nylon 66.
- Color: Natural.

UNIT : mm

Item No.	Dimension H	Packing
LY-14	14.1	100pcs

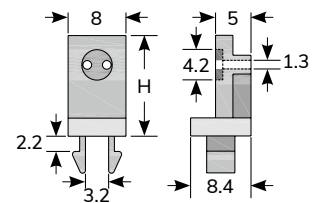

# 1334 KSS LED HOLDER

- Material: UL94V-2 flame rated, UL approved Nylon 66.
- Color: Natural.

UNIT : mm

Item No.	Dimension						Packing
	L	L1	W	H	H1	LED	
LG3-12	7.1	3.6	7.5	15.8	12.0	5Ø3PIN	100pcs
LG3-18	7.1	3.7	7.5	21.6	17.5	5Ø3PIN	

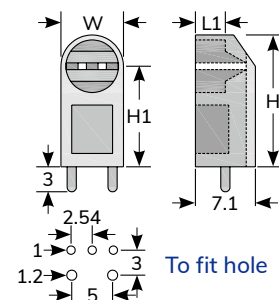

# 1335 KSS LED HOLDER

- Material: UL94V-2 flame rated, UL approved Nylon 66.
- Color: Natural.

UNIT : mm

Item No.	Dimension						Packing
	L	L1	W	H	H1	LED	
LG-8	5.6	3.1	5.5	10.8	7.8	3Ø2PIN	100pcs

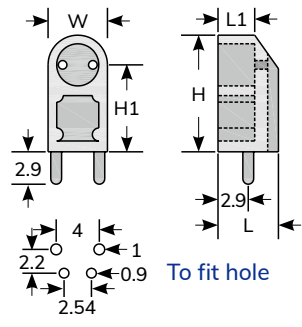

Wiring Ducts

Cable Markers

Cable Ties

Wrapping Bands

Cable Clamps & Tie Mounts

# 1336 KSS LED HOLDER

- Material: UL94V-2 flame rated, UL approved Nylon 66.
- Color: Natural.

UNIT : mm

Item No.	Dimension					Packing
	L	W	H	H1	LED	
LH-4	5.6	5.4	7.2	4.5	5Ø2PIN	100pcs

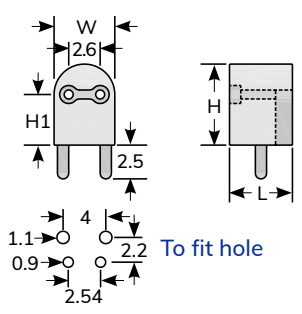

Glands, Bushings

Conduits

Bushings

Wire Connectors

# 1337 KSS LED HOLDER

- Material: UL94V-2 flame rated, UL approved Nylon 66.
- Color: Natural.

UNIT : mm

Item No.	Dimension					Packing
	L	W	H	H1	LED	
LHN-10	5.6	5.5	12.8	10	5Ø2PIN	100pcs

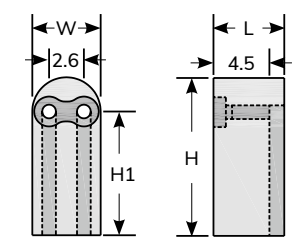

Tubes

Cable Clips

PCB Parts

Fasteners

# 1338 KSS LED HOLDER

- Material: UL94V-2 flame rated, UL approved Nylon 66.
- Color: Natural.

UNIT : mm

Item No.	Dimension						Packing
	L	L1	W	H	H1	LED	
PLU-9	10.2	3.5	8	13.1	9	5Ø3PIN	100pcs

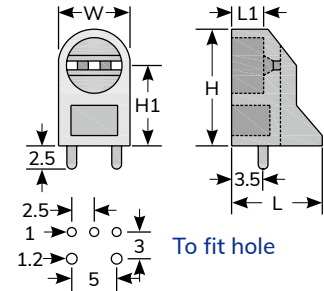

# 1339 KSS LED HOLDER

- Material: UL94V-2 flame rated, UL approved Nylon 66.
- Color: Natural.

UNIT : mm

Item No.	Dimension						Packing
	L	L1	W	H	H1	LED	
LHK-3	6	1	7.6	6	2.7	5Ø3PIN	100pcs

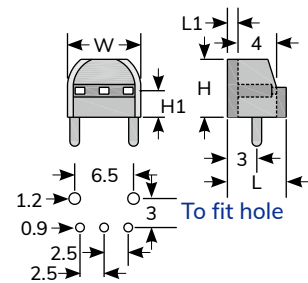

# 1341 KSS LED HOLDER

- Material: UL94V-2 flame rated, UL approved Nylon 66.
- Color: Natural.

UNIT : mm

Item No.	Dimension						Packing
	L	L1	W	H	H1	LED	
PLK-5	8.2	6	7.6	9	4.7	5Ø3PIN	100pcs

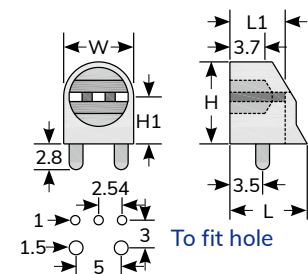



# 1343 KSS LED HOLDER



- Material: UL94V-2 flame rated, UL approved Nylon 66.
- Color: Natural.

UNIT : mm

Item No.	Dimension						Packing
	L	L1	W	H	H1	LED	
PLM-16	6.7	3.4	5.1	18.7	16	3Ø2PIN	100pcs

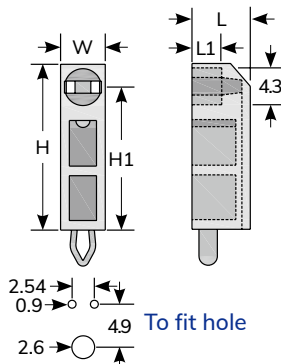

# 1344 KSS LED HOLDER



- Material: UL94V-2 flame rated, UL approved Nylon 66.
- Color: Natural.

UNIT : mm

Item No.	Dimension					Packing
	L	W	H	H1	LED	
PLX-18	7.7	9.6	21.6	18.2	5Ø2PIN	100pcs
PLW-18	9.7	9.0	21.6	18.2	5Ø3PIN	

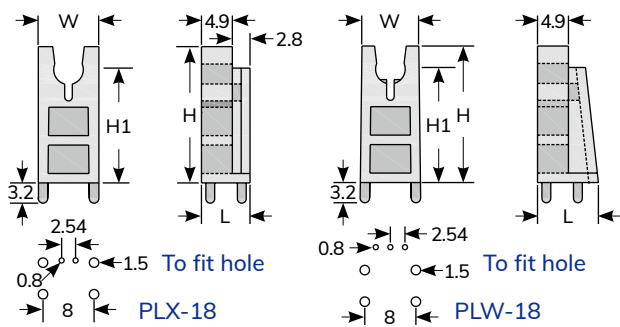

# 1345 KSS LED HOLDER



- Material: UL94V-2 flame rated, UL approved Nylon 66.
- Color: Black.

UNIT : mm

Item No.	Dimension									Packing
	L	L1	W	H	H1	H2	P1	P2	LED	
PLD1-3A	6.5	2.0	4.7	7.5	5.05		4.65		3Ø2PIN	100pcs
PLD2-3A	9.2	2.8	4.5	10.0	2.7	5.0	4.9	7.2	3Ø2PIN	
PLD2-3B	8.2	2.6	4.8	9.9	2.6	5.0	4.8	7.2	3Ø2PIN	
PLD2-5C	11.2	4.5	5.9	12.2	2.95	6.3	5.6	7.7	5Ø2PIN	
PLD4-3A	10.2	1.0	10.2	10.2	2.6	5.0	6.4	9.2	3Ø2PIN	
PLD4-3B	20.4	4.4	22.7	9.0	5.6		15.0		3Ø2PIN	

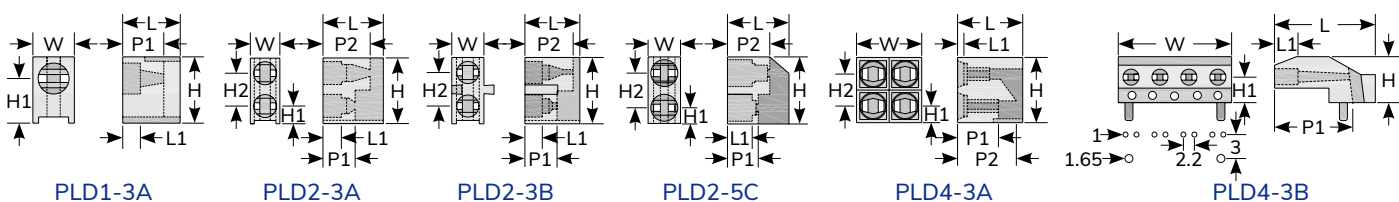

## 1346 KSS LED HOLDER

- Material: UL94V-2 flame rated, UL approved Nylon 66.
- Color: Natural.

UNIT : mm

Item No.	Dimension						Packing
	L	W	H	H1	P1	LED	
PLT-4	6.7	6.7	7	3.7	3.1	5Ø2PIN	100pcs

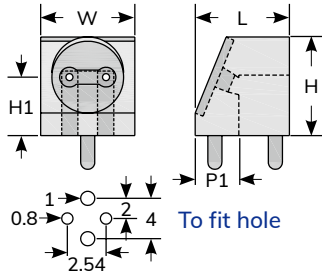

## 1347 KSS LED HOLDER

- Material: UL94V-2 flame rated, UL approved Nylon 66.
- Color: Black.

UNIT : mm

Item No.	Dimension								Packing
	L	L1	W	H	H1	P1	P2	LED	
PLR-4	11	1.2	7.7	8	4	5.8	8	5Ø3PIN	100pcs

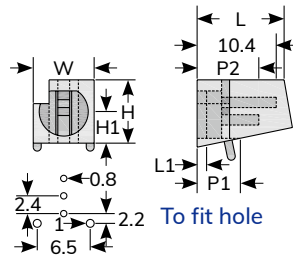

## 1349 KSS LED HOLDER

- Material: UL94V-2 flame rated, UL approved Nylon 66.
- Color: Black.

UNIT : mm

Item No.	Dimension						Packing
	L	L1	D1	D2	T	LED	
PCL-5A	7.2	4.5	6.2	7.8	1.5	Ø5	100pcs
PCL-3H	5.2	3.2	4.8	5.5	1.2	Ø3	

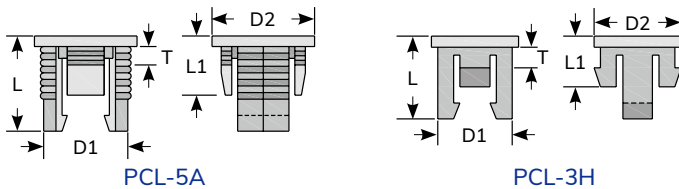

## 1351 KSS CAPACITOR HOUSING

- Material: UL94V-2 flame rated, UL approved Nylon 66.
- Color: Natural.

UNIT : mm

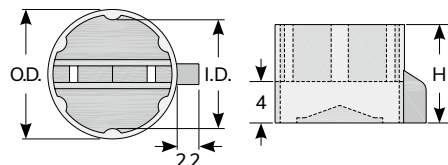

Item No.	Dimension			Packing
	H	O.D.	I.D.	
CAP-10	9.5	12.5	10.4	100pcs



# 1401 KSS PLASTIC SCREWS

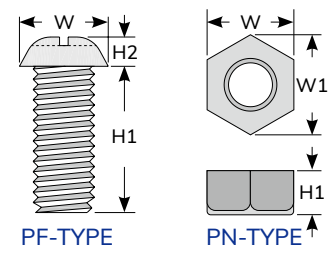

- Material: UL94HB flame rated, UL approved PC / UL94V-2 flame rated, UL approved Nylon 66.
- For better insulation, light weight, no rust.
- Used extensively as metal screw but where insulation is needed. Good for computer or electronics equipment fixation.
- For Nylon 66, Add "N" to Item No. UNIT : mm

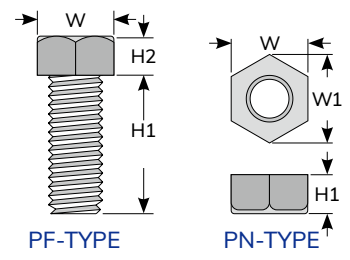

	Item No.		Thread	W	H1	H2	Packing	
	PC	NYLON						
SCREW 		PF-205NK	M2x0.4	4.5	5.0	1.6	1000pcs	
		PF-208NK			8.0			
		PF-210NK			10.0			
		PF-306K	PF-306NK	M3x0.5	5.25	6.0		2.5
		PF-308K	PF-308NK			8.0		
		PF-310K	PF-310NK			10.0		
		PF-312K	PF-312NK			12.0		
		PF-408K	PF-408NK			8.0		
		PF-410K	PF-410NK	M4x0.7	7.5	10.0		2.6
		PF-412K	PF-412NK			12.0		
		PF-414K	PF-414NK			14.0		
		PF-420K	PF-420NK			20.0		
		PF-425K	PF-425NK			25.0		
		PF-520K	PF-520NK	M5x0.8	8.7	20.0		3.5
		PF-530K	PF-530NK			30.0		
		PF-540K	PF-540NK			40.0		
		PF-620K	PF-620NK	M6x1.0	10.0	20.0		4.0
		PF-630K	PF-630NK			30.0		
	PF-640K	PF-640NK	40.0					
NUT 	-	PN-2NK	M2x0.4	4.0	4.5	1.5		
		PN-3K	PN-3NK	M3x0.5	5.6	6.4	2.7	
		PN-4K	PN-4NK	M4x0.7	7.0	8.1	3.2	
		PN-5K	PN-5NK	M5x0.8	8.0	9.2	4.0	
		PN-6K	PN-6NK	M6x1.0	10.0	11.5	5.0	

- Material: UL94V-2 flame rated, UL approved Nylon 66.
- Color: Natural
- For better insulation, light weight, no rust.
- Used extensively as metal screw but where insulation is needed. Good for computer or electronics equipment fixation.



	Item No.	Thread	W	H1	H2	Packing
HEX HEAD SCREW 	PF-820N	M8x1.25	12.8	20	5.4	NYLON 100pcs
	PF-830N			30		
	PF-840N			40		
	PF-1030SN	M10x1.5	13.6	30	5.5	
	PF-1030N			30		
	PF-1040SN			40		
	PF-1040N	16.6	40			
NUT 	PN-8N	M8x1.25	12.8	14.5	6.4	
	PN-10N	M10x1.5	16.7	19.2	8.0	

- Material: UL94V-2 flame rated, UL approved Nylon 66.

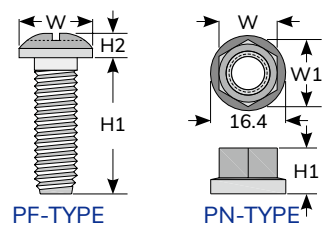

	Item No.	Thread	W	H1	H2	Packing
SCREW 	PF-823HN	Natural	M8x1.25	15.8	22.5	5.5
	PF-823HNGYJ	Grey				
NUT 	PN-8HN	Natural	M8x1.25	12.8	14.6	10
	PN-8HNGYJ	Grey				

## 2001 KSS RJ45 MODULAR PLUG & PLUG COVER

- Design for Cat5, Cat5e, Cat6 cables standard, gilded design for better connection.

### Modular Plug

UNIT : mm

Item No.	Description	Packing
RJ45-8A2	Design for Cat5 , Cat5e Modular Plug (Stranded Wire)	100pcs
RJ45-8A3	Design for Cat5 , Cat5e Modular Plug (Stranded Wire or Solid Wire)	
RJ45-8C6	Design for Cat6 Modular Plug (Stranded Wire or Solid Wire)	
RJ45-8C6A	Design for Cat6 Modular Plug, shield protected (Stranded Wire or Solid Wire)	

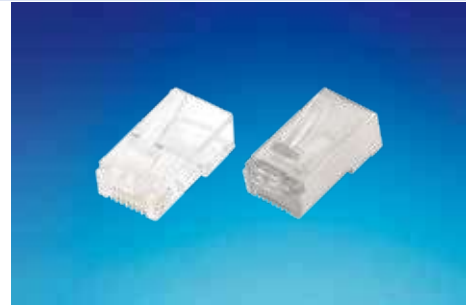

- Design for Cat5, Cat5e, Cat6 cables plug cover, to prevent dust.

### Modular Plug Cover

UNIT : mm

Item No.	Color	I.D.	Packing
RJ45-60GN	Green	6	100pcs
RJ45-60GY	Gray		
RJ45-60RD	Red		
RJ45-60YW	Yellow		
RJ45-60BE	Blue		
RJ45-60BK	Black		
RJ45-C7GY	Gray	7	
RJ45-C7YW	Yellow		



## 2002 KSS DUST COVER FOR RJ45 PLUG

- Material: Flexible PVC.
- Color: Black, available in natural or other colors.
- Function: Dust cover for RJ45 plug.

UNIT : mm

Item No.	Dimension	Packing
RJ45-DC1	As Figure	100pcs

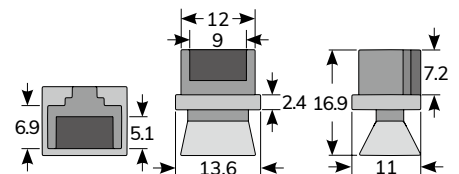
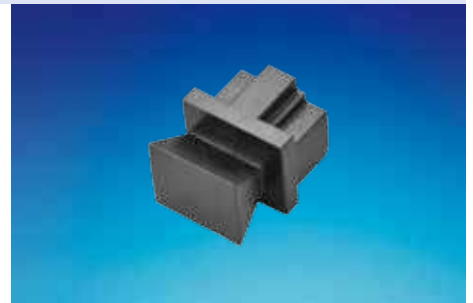

## 2005 U CONNECTOR

- Feature: Conduct the circuit without peeling the wire; also achieve at least UL Category 5's transmission result.

UNIT : mm

Item No.	Maximum Resist Size mm	Wire dia. AWG	Packing
UY2	2.08	19~26	100pcs



# 1501 KSS TERMINAL & TOOL



RING TERMINAL



INSULATED RING TERMINAL



INSULATED BUTT SPLICE



CRIMPING TOOL



Y TERMINAL



Y INSULATED TERMINAL



NYLON INSULATED BUTT SPLICE



CRIMPING TOOL



PIN TERMINAL



PIN INSULATED TERMINAL



FEMALE LUG



WIRE STRIPPER



NON-INSULATED FEMALE LUG



BULLET SOCKET



MALE LUG



WIRE STRIPPER



CABLE LUG



BULLET TERMINAL



NYLON INSULATED FEMALE LUG



CRIMPING TOOL



BUTT SPLICE



PIGGY BACK DISCONNECT



NYLON INSULATED MALE LUG



CRIMPING TOOL



PARALLEL SPLICE



INSULATED FEMALE LUG



CORD END TERMINAL



CRIMPING TOOL

Wiring  
Ducts

Cable  
Markers

Cable  
Ties

Wrapping  
Bands

Cable Clamps  
& Tie Mounts

Glands,  
Bushings

Conduits

Bushings

Wire  
Connectors

Tubes

Cable  
Clips

PCB  
Parts

Fasteners



## BP-650

Contents:  
 CV-100 100pcs Natural  
 CV-100 Colored  
 ( RD, YW, BE, GN )@50pcs  
 CV-200 300pcs Natural  
 CV-280 50pcs Natural

## BP-850

Contents:  
 CV-100 100pcs Natural  
 CV-100 Colored  
 ( RD, YW, BE, GN )@100pcs  
 CV-200 300pcs Natural  
 CV-280 50pcs Natural

## BP-1000

Contents:  
 CV-100 200pcs Natural  
 CV-100 Colored  
 ( RD, YW, BE, GN )@100pcs  
 CV-200 350pcs Natural  
 CV-280 50pcs Natural

## BP-1001

Contents:  
 CV-100 361pcs Natural  
 CV-100 Colored  
 ( RD, YW, BE )@50pcs  
 CV-200 425pcs Natural  
 CV-280 65pcs Natural

## BP-1200

Contents:  
 CV-100 200pcs Natural  
 CV-100 200pcs Black  
 CV-100 Colored  
 ( RD, YW, GN )@100pcs  
 CV-200 400pcs Natural  
 CV-280 100pcs Natural



## CP-300

Contents:  
 CV-100 100pcs Natural  
 CV-100 Colored  
 ( RD, YW, BE, GN )@25pcs  
 CV-200S Colored  
 ( RD, BE )@25pcs  
 CV-200S 50pcs Natural

## CP-400

Contents:  
 CV-100 Colored  
 ( RD, BE, GN )@100pcs  
 CV-200S 100pcs Natural

## CPH-1000

Contents:  
 CV-100 1000pcs Colored



## DB-75BK

Contents:  
 CV-094BK 25pcs Black  
 CV-120LBK 25pcs Black  
 CV-190BK 25pcs Black

## DB-75

Contents:  
 CV-094 25pcs Natural  
 CV-120L 25pcs Natural  
 CV-190 25pcs Natural

## DB-75C

Contents:  
 CV-094 25pcs Natural  
 CV-120LRD 25pcs Red  
 CV-190YW 25pcs Yellow

## VP-75-3C

Contents:  
 CV-100 25pcs Natural  
 CV-140 25pcs Natural  
 CV-200A 25pcs Natural

## VP-75L

Contents:  
 CV-100 25pcs Natural  
 CV-150 25pcs Natural  
 CV-200 25pcs Natural

※COLORS AVAILABLE

# KSS CABLE TIES



- VP-50-4BK**  
Contents: CV-100BK 50pcs Black
- VP-50-4NA**  
Contents: CV-100 50pcs Natural
- VP-50-8BK**  
Contents: CV-200SBK 50pcs Black
- VP-50-11NA**  
Contents: CV-280 50pcs Natural
- VP-50-11BK**  
Contents: CV-280BK 50pcs Black



- VP-50-48C**  
Contents:  
CV-100 25pcs Black(6), Red(7), Yellow(6), Blue(6)  
CV-200S 25pcs Black(6), Red(7), Yellow(6), Blue(6)
- VP-50-48YW**  
Contents: CV-100YW 25pcs Yellow  
CV-200SYW 25pcs Yellow
- VP-50-48BK**  
Contents: CV-100BK 25pcs Black  
CV-200SBK 25pcs Black
- VP-50-48RD**  
Contents: CV-100RD 25pcs Red  
CV-200SRD 25pcs Red
- VP-50-48NA**  
Contents: CV-100 25pcs Natural  
CV-200S 25pcs Natural



- VP-50-811YW**  
Contents: CV-200SYW 25pcs Yellow  
CV-280YW 25pcs Yellow
- VP-50-811RD**  
Contents: CV-200SRD 25pcs Red  
CV-280RD 25pcs Red
- VP-50-811BE**  
Contents: CV-200SBE 25pcs Blue  
CV-280BE 25pcs Blue
- VP-50-811NA**  
Contents: CV-200S 25pcs Natural  
CV-280 25pcs Natural
- VP-50-811BK**  
Contents: CV-200SBK 25pcs Black  
CV-280BK 25pcs Black



- PB-100-5NA**  
Contents: CV-120S 100pcs Natural
- PB-100-6.5NA**  
Contents: CV-165 100pcs Natural
- PB-100-8NA**  
Contents: CV-200A 100pcs Natural
- PB-100-10NA**  
Contents: CV-250 100pcs Natural

※COLORS AVAILABLE

# KSS CABLE TIES

VALUE PACK



## VP-50-4811C

Contents:  
 CV-100 20pcs Red(5), Blue(5), Yellow(5), Black(5)  
 CV-200S 20pcs Red(5), Blue(5), Yellow(5), Black(5)  
 CV-280 10pcs Red(2), Blue(3), Yellow(2), Black(3)

## VP-50-811C

Contents:  
 CV-200S 25pcs Red(7), Blue(6), Yellow(6), Black(6)  
 CV-280 25pcs Red(7), Blue(6), Yellow(6), Black(6)

## VP-150-4811C

Contents:  
 CV-100 50pcs Red(10), Blue(10), Yellow(10), Black(10), Natural(10)  
 CV-200S 50pcs Red(10), Blue(10), Yellow(10), Black(10), Natural(10)  
 CV-280 50pcs Red(10), Blue(10), Yellow(10), Black(10), Natural(10)



## PB-100-4NA

Contents: CV-100 100pcs Natural

## PB-100-4BK

Contents: CV-100BK 100pcs Black

## PB-100-4YW

Contents: CV-100YW 100pcs Yellow

## PB-100-4RD

Contents: CV-100RD 100pcs Red

## PB-100-4BE

Contents: CV-100BE 100pcs Blue

## PB-100-4GN

Contents: CV-100GN 100pcs Green



## PB-100-4C

Contents:  
 CV-100YW 50pcs Yellow CV-100RD 50pcs Red

Contents:  
 CV-100GN 50pcs Green CV-100RD 50pcs Red

Contents:  
 CV-100RD 50pcs Red CV-100BK 50pcs Black

Contents:  
 CV-100GN 50pcs Green CV-100BK 50pcs Black

Contents:  
 CV-100YW 50pcs Yellow CV-100BK 50pcs Black



## DB-350

Contents:  
 CV-100 100pcs Natural  
 CV-100C 100pcs Colored (RD, BE, YW, BK)@25pcs  
 CV-200S 50pcs Natural  
 CV-200SC 50pcs Colored (YW, BK)@13pcs (RD, BE)@12pcs  
 CV-280C 50pcs Colored (YW, BK)@13pcs (RD, BE)@12pcs

※COLORS AVAILABLE



# KSS CABLE TIES

VALUE PACK



## EP-400

Contents:

- CV-100 200pcs  
(Neon PK, OE, GN, YW)@50pcs
- CV-150 100pcs  
(Neon PK, OE, GN, YW)@25pcs
- CV-200 100pcs  
(Neon PK, OE, GN, YW)@25pcs



## EP-510

Contents:

- CV-100 200pcs  
( Colored RD, BE, YW, GN ) @50pcs
- CV-200 100pcs  
( Colored Natural, Black ) @50pcs
- CV-200S 200pcs  
( Colored RD, BE, YW, GN ) @50pcs
- MGT-240C 10pcs  
( Colored RD, BE, YW, GN, BK ) @2pcs



## PHB-200BK-10

Contents:

- HB-200BK 10pcs Black



## QP-500

Contents:

- CV-100 100pcs Natural
- CV-100C 100pcs  
( Colored RD, BE, YW, BK ) @25pcs
- CV-140 100pcs Natural
- CV-140BK 100pcs Black
- CV-180 50pcs Natural
- CV-180BK 50pcs Black



## PVA150C-20

Contents:

- Butterfly @5pcs Pink
- Giraffe @5pcs Neon Orange
- Rabbit @5pcs Neon Green
- Elephant @5pcs Blue



## DP-2-A05NYW

Contents: Star @2pcs Yellow

## DP-2-A11NOE

Contents: Ribbon @2pcs Orange

## DP-2-A02NGN3

Contents: Clover @2pcs Green

## DP-2-A06PK

Contents: Flower @2pcs Pink



## DP-2-DE1BK

Contents: Taiwan @2pcs Black

## DP-2-DE1NGN3

Contents: Taiwan @2pcs Green

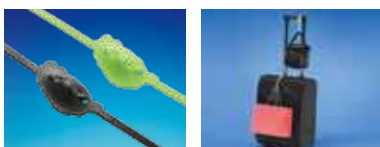

## PVF150C-20

Contents:

- Clover / Apple @2pcs Neon Green
- Heart / Ribbon @2pcs Pink
- Butterfly / Star @2pcs Yellow
- Flower / Giraffe @2pcs Neon Orange
- Rabbit / Elephant @2pcs Blue

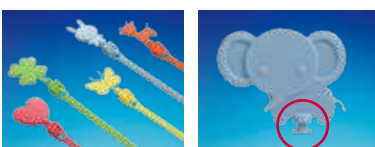

# KSS CABLE CLIPS

VALUE PACK



## PB-10-NF

Contents:  
NF-0.7 10Pcs White



## DB-25-NF2.6S

Contents:  
NF-2.6S 25pcs White



## DB-47

Contents:  
DNF-13 7pcs White  
NC-1.5NBK 20pcs Black  
US-13 20pcs



## QPH-500-28S

Contents:  
NF-2.8S  
500pcs / Bucket White



## DB-25

Contents:  
NT-1 5pcs  
NC-0.5N 10pcs  
NC-1.5N 5pcs  
NC-3N 5pcs

## DB-100

Contents:  
CV-075 30pcs  
CV-100 20pcs  
KW-1 10pcs  
CE-2 9pcs  
CE-5 9pcs  
UC-0.5 6pcs  
UC-1 8pcs  
UC-2 8pcs



## SMALL BOX

SNC-0.4N  
Contents: NC-0.4N 100pcs White  
SNC-0.5N  
Contents: NC-0.5N 100pcs White  
SNC-1N  
Contents: NC-1N 100pcs White

## MEDIUM BOX

MNC-1.5N  
Contents: NC-1.5N 100pcs White  
MNC-2N  
Contents: NC-2N 100pcs White  
MNC-2.5N  
Contents: NC-2.5N 100pcs White

## LARGE BOX

LNC-3N  
Contents: NC-3N 100pcs White  
LNC-3.5N  
Contents: NC-3.5N 100pcs White  
LNC-4N  
Contents: NC-4N 100pcs White

※ AVAILABLE IN DIFFERENT QUANTITY / SIZE / COLOR

# KSS CABLE CLIPS



## QB-500

Contents:  
NC-0810 500pcs White

## QB-800

Contents:  
NC-0.4N 300pcs Grey  
NC-0.5N 300pcs Grey  
NF-2.0 100pcs White  
NF-2.2 100pcs White

## QB-850

Contents:  
NC-0.4N 300pcs Grey  
NC-1.5N 150pcs Grey  
NC-2.5N 100pcs Grey  
NF-1.2BK 300pcs Black

## QBS-400

Contents:  
NC-1NWE 100pcs White  
NC-1.5NWE 100pcs White  
NC-2NWE 100pcs White  
NC-2.5NWE 100pcs White

## QB-1200

Contents:  
NC-0.5N 1200pcs Grey

※ AVAILABLE IN DIFFERENT  
QUANTITY / SIZE / COLOR

VALUE PACK



CABLE CLIPS ALSO  
AVAILABLE IN 4  
COMPARTMENT SQUARE  
CANISTER PACKING

### ● ROUND CLIPS

Item No.	W (mm)	Packing
PNC-0.35N	3.5	100 pcs/box
PNC-0.4N	4	
PNC-0.5N	5	
PNC-1N	6	
PNC-1.5N	7	
PNC-2N	8	
PNC-2.5N	9	
PNC-3N	10	
PNC-3.5N	11	
PNC-4N	12	
PNC-6N	14	
PNC-7N	16	
PNC-7.5N	20	
PNC-8N	22	50 pcs/box
PNC-9N	25	25 pcs/box
PNC-10N	32	

### ● FLAT CLIPS

Item No.	W (mm)	Packing
PNF-0.7	5.5	100 pcs/box
PNF-1.2	6.2	
PNF-1.6	8.0	
PNF-2.0	8.5	
PNF-2.2	10.0	
PNF-2.6	13.5	
PNF-2.6S	13.5	
PNF-2.8	15	
PNF-2.8S	15	
PNF-3.0	18	
PNF-3.2	19	

## KSS FEARLESS HANDBAR

VALUE PACK



### MFH-1BEKY

Contents: 1pcs  
Colored **Blue**

### MFH-1BK

Contents: 1pcs  
Colored **Black**

### MFH-NYW2

Contents: 1pcs  
Colored **Yellow**

### MFH-1WEKY

Contents: 1pcs  
Colored **White**

## KSS TWIST TIE



### PB-30TT11GN

Contents:  
TT-11GN 30pcs **Green**

### PB-20TT18YW

Contents:  
TT-18YW 20pcs **Yellow**

### PB-30TT11BE

Contents:  
TT-11BE 30pcs **Blue**

### PB-30TT11RD

Contents:  
TT-11RD 30pcs **Red**

## KSS CABLE CLAMPS



### VS-24-HC100C

Contents:  
HC-100-S4 12pcs **Natural**  
HC-100BK-S4 12pcs **Black**

## KSS SM TYPE COLOR CODED CABLE MARKER



### PB-SM0C-09

Contents:  
**SM-0** 0 ~ 9 250pcs  
 ( Colored BK, BN6, RD, OE, YW2, GN, BEC, VT, GY, WE ) @25 pcs

### PB-SM0YW-AM

Contents:  
**SM-0** A ~ M 325pcs Yellow @25pcs

### PB-SM0YW-NZ

Contents:  
**SM-0** N ~ Z 325pcs Yellow @25pcs



### PB-SM1C-09

Contents:  
**SM-1** 0 ~ 9 150pcs  
 ( Colored BK, BN6, RD, OE, YW2, GN, BEC, VT, GY, WE ) @15pcs

### PB-SM1YW-AM

Contents:  
**SM-1** A ~ M 195pcs Yellow @15 pcs

### PB-SM1YW-NZ

Contents:  
**SM-1** N ~ Z 195pcs Yellow @15 pcs

### PB-SM2C-09

Contents:  
**SM-2** 0 ~ 9 150pcs  
 ( Colored BK, BN6, RD, OE, YW2, GN, BEC, VT, GY, WE ) @15pcs

### PB-SM2YW-AM

Contents:  
**SM-2** A ~ M 195pcs Yellow @15pcs

### PB-SM2YW-NZ

Contents:  
**SM-2** N ~ Z 195pcs Yellow @15pcs

### PB-SM3C-09

Contents:  
**SM-3** 0 ~ 9 100pcs  
 ( Colored BK, BN6, RD, OE, YW2, GN, BEC, VT, GY, WE ) @10pcs

### PB-SM3YW-AM

Contents:  
**SM-3** A ~ M 130pcs Yellow @10pcs

### PB-SM3YW-NZ

Contents:  
**SM-3** N ~ Z 130pcs Yellow @10pcs

VALUE PACK

## KSS CABLE CLAMPS



### PB-12FC3BK

Contents:  
**FC-3BK** 12pcs Black



### PB-5-AP

Contents:  
**AP-1720NA** 5pcs Natural

# KSS SCREW ON WIRE CONNECTOR

VALUE PACK



## DB-25-SW

Contents:  
 SW-73BH 10pcs Orange  
 SW-74BH 10pcs Yellow  
 SW-76BH 5pcs Red



## DB-25-73B

Contents:  
 SW-73BH 25pcs Orange



## DB-20-74B

Contents:  
 SW-74BH 20pcs Yellow



## QP-115-SW

Contents:  
 SW-71BH 25pcs Grey  
 SW-72BH 25pcs Blue  
 SW-73BH 20pcs Orange  
 SW-74BH 20pcs Yellow  
 SW-76BH 25pcs Red

## QP-80-SW

Contents:  
 SW-72BH 25pcs Blue  
 SW-73BH 25pcs Orange  
 SW-74BH 30pcs Yellow

## QP-50-SW

Contents:  
 SW-73BH 50pcs Orange

## QP-40-SW

Contents:  
 SW-73BH 20pcs Orange  
 SW-74BH 20pcs Yellow

# KSS BUTT SPLICE (WATER PROOF & HEAT SHRINKABLE)



## CBHS-50C

Contents:  
 BHS-1.25 20pcs Red  
 BHS-2.0 20pcs Blue  
 BHS-5.5 10pcs Yellow

## KSS TERMINALS



### DB-50-RF5-8

Contents:  
RF5.5-8 50pcs Yellow

### DB-25-RF2-4

Contents:  
RF2-4 25pcs Blue

### DB-10-YF1-4

Contents:  
YF1.25-4 10pcs Red



### DB-40

Contents:  
YF1.25-3S 5pcs Red  
YF5.5-5 3pcs Yellow  
RF1.25-4 3pcs Red  
RF2-5 7pcs Blue  
BF-1.25S 5pcs Red  
BF-2.0S 4pcs Blue  
BF-5.5S 3pcs Yellow  
LV1.25-5A 5pcs Red  
LV2-5A 5pcs Blue

VALUE PACK

## KSS CORD END TERMINAL



### ET-075-500

Contents:  
ET0.75-8 White 500pcs/bag+Header

### ET-35-50

Contents:  
ET35-25 Red 50pcs/bag+Header



### TB-4-100

Contents:  
ET4-10 50pcs Orange  
(Grey is Available)  
ET6-12 20pcs Green  
(Black is Available)  
ET10-12 20pcs Brown  
(Ivory is Available)  
ET16-10 10pcs Ivory  
(Green is Available)

### TB-5-400

Contents:  
ET0.75-8 100pcs Blue  
(White is Available)  
ET0.5-8 50pcs White  
(Orange is Available)  
ET1.0-8 100pcs Red  
(Yellow is Available)  
ET1.5-8 100pcs Black  
(Red is Available)  
ET2.5-8 50pcs Grey  
(Blue is Available)

※ AVAILABLE IN DIFFERENT QUANTITY / SIZE / COLOR

# KSS HEAT-SHRINKABLE TUBINGS

VALUE PACK



## RP-F32-10

Contents:  
WK32-10 2M Black

## RP-F32-10YW

Contents:  
F32-10YW 2M Yellow

## RP-F32-10GN

Contents:  
F32-10GN 2M Green

## RP-F32-10RD

Contents:  
F32-10RD 2M Red

## RP-F32-10BE

Contents:  
F32-10BE 2M Blue

## RP-F32-10WE

Contents:  
F32-10WE 2M White



## VS-25

Contents:  
WK32-3 12.7cm Black 5pcs  
WK32-5 12.7cm Black 5pcs  
WK32-8 12.7cm Black 5pcs  
WK32-10 12.7cm Black 5pcs  
WK32-15 12.7cm Black 5pcs

## VS-100

Contents:  
F32-1.5 3.5cm Red,Blue,White,Yellow @5pcs  
F32-2.5 3.5cm Red,Blue,White,Yellow @5pcs  
F32-3.5 3.5cm Red,Blue,White,Yellow @5pcs  
F32-5 3.5cm Red,Blue,White,Yellow @5pcs  
F32-7 7.5cm Red,White @3pcs Blue,Yellow @2pcs  
F32-10 7.5cm Red,White,Yellow @1pcs, Blue 2pcs  
F32-13 7.5cm Red,White,Yellow @1pcs, Blue 2pcs

## VS-100BK

Contents:  
WK32-1.5 3.5cm Black 20pcs  
WK32-2.5 3.5cm Black 20pcs  
WK32-3.5 3.5cm Black 20pcs  
WK32-5 3.5cm Black 20pcs  
WK32-7 7.5cm Black 10pcs  
WK32-10 7.5cm Black 5pcs  
WK32-13 7.5cm Black 5pcs



## SP-07-7BK

Contents:  
WK32-7 12" /PC, 7pcs/bag Black

## SP-09-3BK

Contents:  
WK32-3.5 12" /PC, 9pcs/bag Black

## SP-08-5BK

Contents:  
WK32-5 12" /PC, 8pcs/bag Black

## SP-09-357C

Contents:  
F32-3.5 12"/PC, 3pcs White  
F32-5 12"/PC, 3pcs Red  
WK32-7 12"/PC, 3pcs Black  
(TOTAL 9pcs/bag)

※ 12"=30.5CM

※ AVAILABLE IN DIFFERENT QUANTITY / SIZE / COLOR



## Technical Data

### KSS Management Certification

Icon	Name	Explanation	For the following activities
	ISO 9001	Quality management systems	Wiring Ducts, Cable Markers, Cable Ties, Cable Clamps, Flexible Conduits, Cable Glands, Bushings, Wire Connectors, Tubes, PCB Parts, Fasteners, etc. design and manufacturing.
	ISO 14001	Environmental management systems	Wiring Ducts, Cable Markers, Cable Ties, Cable Clamps, Flexible Conduits, Cable Glands, Bushings, Wire Connectors, Tubes, PCB Parts, Fasteners, etc. design and manufacturing.
	ISO 45001	Occupational Health and Safety Management Systems	Wiring Ducts, Cable Markers, Cable Ties, Cable Clamps, Flexible Conduits, Cable Glands, Bushings, Wire Connectors, Tubes, PCB Parts, Fasteners, etc. design and manufacturing.
	IATF 16949	The requirements of a quality management system for organizations in the automotive industry	Cable Ties, Flexible Conduits
	ISO/IEC 17025	General requirements for the competence of testing and calibration laboratories	Plastic Cable Ties-Loop Tensile Strength

### KSS Safety Certification

Icon	Country	Name	Corresponding products
	USA+Canada	UL Recognized Product Marks for the USA & Canada	Cable Tie(CV, CV-W, CV-HS, MCV, PFVS, PSV, PWV, PWVS, TCV, TCVS) Stainless Steel Cable Tie(BST,BCT)
	USA	UL Recognized Product Marks for the USA	Cable Tie(CV914,940,1219), Close-End Wire Connector(CE) Screw On Wire Connector(SW)
	USA+Canada	UL Recognized Component Marks for the USA & Canada	Wiring Duct(AD,BD,GD,HD,HVD,KD,KVD, MD,MID,MPD,PD,SD,VD,TC,TF) \\ Cable Tie(HV, HV-W) Heat-Shrinkable Tubing(NHR2)
	USA	UL Recognized Component Marks for the USA	Cable Gland(AG,EG,AG-SR,EG-SR,NPT, AG-D,AGJ) Bushing(SR,OSB,SB) PVC Tube(NHS) Heat-Shrinkable Tubing (K2,W3F2,F32,FZ,NHR4,B2)
	USA+Canada	Canada Standards Association for Canada & USA	Wiring Duct(AD,BD,GD,HD,HVD,KD,KVD, MD,MID,MPD,PD,SD,UD,VD,VDC,TF)
	Canada	Canada Standards Association for the Canada	Close-End Wire Connector(CE) Screw On Wire Connector(SW) Bushing(SR) PVC TUBE(NHS) Heat-Shrinkable Tubing(W3F2,B2)
	Germany	VDE Prüf- und Zertifizierungsinstitut	Wiring Duct(MD,KD,HD,HVD,VD) Cable Tie(CV, CV-W)
	Norway+Germany	Det Norske Veritas & Germanischer Lloyd	Cable Tie(CV, CV-W, TCV, MCV, HV)
	UK	Lloyd's Register Marine and Shipping	Cable Tie(CV, CV-W)
	USA	American Bureau of Shipping	Cable Tie(CTF,CV,CVS,CVT,DCV,DK,DL,FCV, HV,HVC,HRCV,KFC,KTV,MCV,PCV,PCVS,PDV, PFVS,PGV,PHV,PMA,PRVS,PSV,PUV,PWV, PWVS,RCV,RDCV,RRCV,SCT,TCV,TCVS,TV, WCT)
	European	European Conformity	Wiring Duct(MD,KD,HD,HVD,VD) Cable Tie(CV, CV-W) Cable Gland(AG,AGJ,EG,NPT,NPTA) Flexible Conduit(BG,CRS,PA) Close-End Wire Connector(CE,CE-V0)
	UK	UK Conformity Assessed	Wiring Duct(MD,KD,HD,HVD,VD) Cable Tie(CV, CV-W) Cable Gland(AG,AGJ,EG,NPT,NPTA) Flexible Conduit(BG,CRS,PA) Close-End Wire Connector(CE,CE-V0)

# Technical Data

## KSS Marking

Icon	Name	Explanation
	RoHS	Restriction of Hazardous Substances Directive (2011/65/EU & 2015/863/EU)
	Halogen Free	Halogen Free
	UV resistance	UV resistance
	Acid and alkali resistance	Acid and alkali resistance
	High temperature resistance	High temperature resistance
	UL94V-0	UL94V-0 Flammability rating
	IP68	6 degree of protection against access and foreign bodies. 8 degree of protection for water.
	IP55	5 degree of protection against access and foreign bodies. 5 degree of protection for water.

## RoHS (Restriction of Hazardous Substances)

RoHS is a European Union directive that restricts the use of hazardous substances in electrical and electronic equipments:

	Directive	Substance	Limit (ppm)
	2011/65/EU	Cadmium (Cd)	100
		Lead (Pb)	1,000
		Mercury (Hg)	1,000
		Hexavalent chromium (Cr6+)	1,000
		Polybrominated biphenyls (PBBs)	1,000
		Polybrominated diphenyl ethers (PBDEs)	1,000
	(EU) 2015/863	Bis(2-ethylhexyl) phthalate (DEHP)	1,000
		Butyl benzyl phthalate (BBP)	1,000
		Dibutyl phthalate (DBP)	1,000
		Diisobutyl phthalate (DIBP)	1,000

## Halogen and Halogen-Free

The Halogens are a group of chemical elements consisting of Fluorine (F), Chlorine (Cl), Bromine (Br), Iodine (I) and Astatine (At). It may result from Dioxin-like compounds after the halogen compounds included products are burnt, which is harmful to health by accumulating in organism. The international companies announced the Halogen-Free requirements based on the IEC 61249-2-21 standard. The requirements show below:

	Standard	IEC 61249-2-21		
	Substance	Bromine (Br)	Chlorine (Cl)	Bromine (Br) + Chlorine (Cl)
	Limit (ppm)	900	900	1,500

※The use of other harmful halogenated compounds is restricted by various regulations, e.g. RoHS, REACH-SVHC, etc.

# Technical Data

## KSS Material Specification Overview

Material	Shortcut	Temperature	Flammability	Properties	Environment
NYLON66	PA66	Installation Temperature 0°C Operating Temperature -40~85°C	UL94V-2	※High yield strength	
	PA66-W	Installation Temperature 0°C Operating Temperature -40~85°C	UL94V-2	※High yield strength ※UV resistance	
	PA66-HS	Installation Temperature 0°C Operating Temperature -40~105°C	UL94V-2	※High yield strength ※Heat stabilized	
	PA66-V0	Operating Temperature -40~85°C	UL94V-0	※High yield strength ※Flame retardant, low smoke emission	
	PA66-CW	Operating Temperature -40~85°C	UL94HB	※High yield strength ※Resistance to low temperature, UV light, and high impact	
	PA66-MD		UL94HB	※High yield strength ※Metal and X-Ray detectable	
NYLON6	PA6		UL94HB	※High yield strength	
NYLON612	PA612		UL94HB	※Low moisture absorption ※UV resistance and chemical resistance	
NYLON12	PA12		UL94HB	※Low moisture absorption ※Resistance to chemicals and UV light	
NYLON46	PA46	150°C	UL94V-2	※Low moisture absorption ※High temperature resistance	
Polypropylene	PP			※Floats in water ※Resistance to chemicals and high impact	
	PP-V0		UL94V-0	※Floats in water ※Resistance to chemicals and high impact ※Flame retardant	
Polyethylene	LDPE			※Floats in water ※Low moisture absorption ※Better resistance to low temperature ※Weaker resistance to heat and UV light	
	HDPE			※Floats in water ※Low moisture absorption. ※Better resistance to heat ※Better mechanical properties, like hardness and tensile strength	
Polyvinyl Chloride	Rigid PVC	Service temperature 85°C UL test up to 50°C	UL94V-0	※Low moisture absorption ※Resistance to high impact, chemicals, acids, and oils	
	Flexible PVC			※Low moisture absorption	
Polycarbonate	PC		UL94V-2	※Transparent ※Strong mechanical properties and resistance to heat	
Acrylonitrile Butadiene Styrene	ABS		UL94HB	※Resistance to high impact	
PC/ABS Alloy	PC/ABS		UL94V-0	※Resistance to low temperature and high impact	
Stainless steel	304	Operating Temperature -60~300°C	Non-burning	※Good in UV resistance and chemical resistance.	
	316	Operating Temperature -60~300°C	Non-burning	※Excellent in UV resistance and chemical resistance.	

## UL94

### 【UL 94 HB (Horizontal Burning)】

Specimens :  
 Length : 125±5mm  
 Width : 13±0.5mm  
 Thickness : <3mm or 3~13mm

Procedure :  
 The sample and the fire were horizontally contacted at an angle of 45 degrees for 30 seconds and then moved away. The depth of contact was 6 ± 1 mm. Observe its burning situation, meet any of the following requirements, that is, meet.

Criteria condition	Requirement
Burning rate	Test specimen thickness 3 - 13 mm , ≤ 40 mm/min
	Test specimen thickness < 3 mm , ≤ 75 mm/min
Burning length	Flame is extinguished before 100mm mark

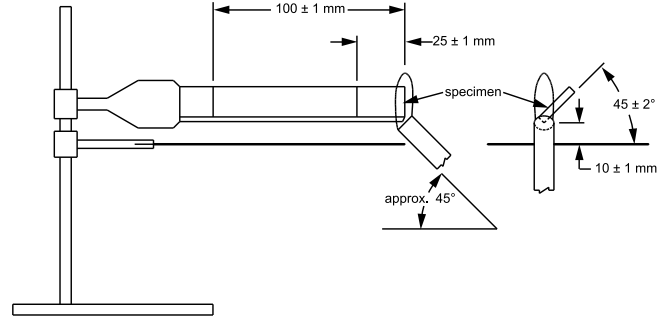

### 【UL 94 V (Vertical Burning)】

Specimens :  
 Length : 125±5mm  
 Wide : 13±0.5mm  
 Thickness : 0.025 mm~13mm

Procedure :  
 With a fire of 50 W, a height of 20 mm, and vertical contact with the specimen for 10 seconds twice, observe the remaining flames and embers.

Perform the following two stages of testing:  
 1) The first stage: the specimen is pre-treated (temperature 23 ± 2°C, relative humidity 50 ± 5%, 48 hours), and after passing the test of the following test items, the second stage test is performed.  
 2) The second stage: the specimen is pretreated (temperature 70 ± 1°C, 168 hours, and cooled at room temperature for 4 hours). After passing the test of the following test items, the grade can be determined.

Criteria condition	Requirement		
	V-0	V-1	V-2
Afterflame time for each individual specimen t1(s)	≤ 10	≤ 30	≤ 30
Afterflame time for each individual specimen t2(s)	≤ 10	≤ 30	≤ 30
Total afterflame time for any condition set (t1 plus t2 for the 5 specimens) (s)	≤ 50	≤ 250	≤ 250
Afterflame plus afterglow time for each individual specimen after the second flame application (t2+t3) (s)	≤ 30	≤ 60	≤ 60
Afterflame or afterglow of any specimen up to the holding clamp	No	No	No
Cotton indicator ignited by flaming particles or drops	No	No	Yes

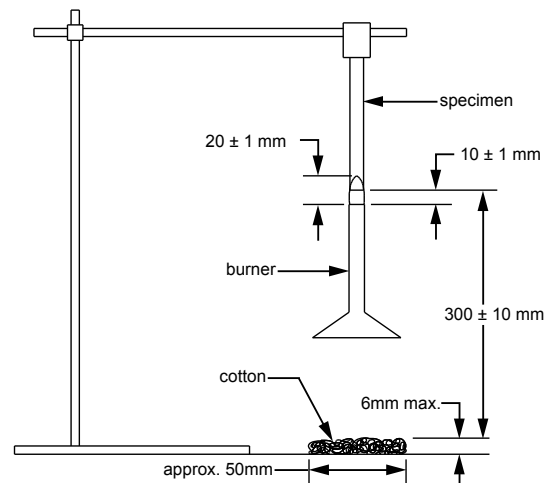

※According to the severity of the test method of fire resistance test, its grade from good to bad: HB> V0> V1> V2

## Adhesive Tape

Storage condition:

Adhesive tape should be stored indoors in normal temperature and humidity, despite adhesive itself lasts years, adhesive tape only lasts about 2 years. Because silicone used on the liner will transfer to the adhesive during time, which affects the adhesion.

Instruction:1. Clean the surface before applying to keep adhesive tape from dust and dirt.

2. Apply 15psi※ pressure for a proper time (refer to table below) before loading.

The adhesion strength determined by adhesive type, shows below:

Adhesive type	Acrylic				Rubber
Feature	Low initial adhesion High ultimate adhesion Long-term durability				High initial adhesion Medium ultimate adhesion Moderate durability (approx. 2 years)
Time →	Initial	20 min.	1 day	3 days	Reach 100% strength in short time.
Strength →	20%	50%	90%	100%	

※psi - pound per square inch

## IP Code

The IP Code (Ingress protection code), it is published by the International Electrotechnical Commission (IEC). It consists of two characteristics. The first characteristic indicates the level of protection that the enclosure provides against access to hazardous parts and the ingress of solid foreign objects. The second characteristic indicates the level of protection that the enclosure provides against harmful ingress of water. The detail explanation are as follows:

KSS IP68 dustproof and waterproof Cable Glands series include: AG, EG (washer required), CAG, CEG (washer required), AGJ, NPT, NPTA, AG-SR, EG-SR, etc.

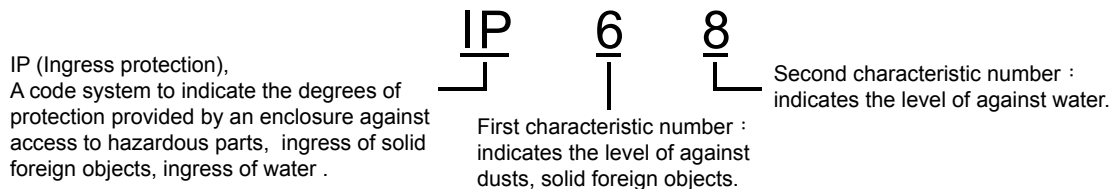

First characteristic number	Protection ability	Second characteristic number	Protection ability
0	Non-protected	0	Non-protected
1	 Protected against solid foreign objects of 50mm diameter and greater	1	 Vertically falling water drops
2	 Protected against solid foreign objects of 12.5mm diameter and greater	2	 Dripping water when tilted at 15°
3	 Protected against solid foreign objects of 2.5mm diameter and greater	3	 Spraying water
4	 Protected against solid foreign objects of 1.0mm diameter and greater	4	 Splashing water
5	 Dust-protected	5	 Water jets
6	 Dust-tight	6	 Powerful water jets
		7	 Temporary immersion in water (up to 1 meter depth)
		8	 Continuous immersion in water (1 ~1.5 meter depth)

## Terminal index

**RF**   **1.25**   **6**  
 Item No.   Wire range (mm<sup>2</sup>)   Tube length (mm)

STUD SIZE	
mm - inch	mm - inch
3.2 - #4	6.4 - 1/4"
3.7 - #6	8.4 - 5/16"
4.3 - #8	10.5 - 3/8"
5.3 - #10	13.0 - 1/2"

INSULATED COLOR	
<b>RED:</b>	1.25 mm <sup>2</sup> = AWG 22-16
<b>BLUE:</b>	2.0 mm <sup>2</sup> = AWG 16-14
<b>BLACK:</b>	3.5 mm <sup>2</sup> = AWG 14-12
<b>YELLOW:</b>	5.5 mm <sup>2</sup> = AWG 12-10
● WELCOME FOR SPECIAL COLOR REQUEST	

■ The above color cards are for reference only.

TECHNICAL DATA

Item No.	Product Name
R	Ring Terminal
Y	Y Terminal
H	Hook Terminal
LY	Flanged Spade Terminal
RF	Insulated Ring Terminal
YF	Insulated Y Terminal
ERF	Easy Entry Insulated Ring Terminal
EYF	Easy Entry Insulated Y Terminal
HF	Insulated Hook Terminal
LYF	Flanged Spade Insulated Terminal
B	Butt Splice
P	Parallel Splice
PIN-AF	Pin Insulated Terminals
PIN	Pin Terminals
EPIN-AF	Easy Entry Pin Insulated Terminals
BF	Butt Splice Insulated
BHS	Butt Splice (Water Proof & Heat Shrinkable)
BN	Nylon Insulated Butt Splice
LV-B	Male Lug
LV-A	Female Lug
1.25-7A 2-7A 5.5-7A	Non Insulated Female Lug
PV-A	Insulated Female Lug
MF-A	Piggy Back Disconnects
PN-A	Nylon Insulated Female Lug
PN-B	Nylon Insulated Male Lug
ELV-B	Easy Entry Male Lug
ELV-A	Easy Entry Female Lug
CLV-A	Female Lug Cover
F-B	Insulated Bullet
F-A	Fully Receptacle
FNH-B	Nylon Insulated Bullet
FNH-A	Nylon Fully Receptacle
FL-A	Flag Femaed Disconnects
VTL	Vinyl Flag Sleeve
FLN-A	Nylon Insulated Flag Femaed Disconnects
BD	Blade Terminal
BD-F	Blade Insulated Terminal
LB	Lipped Blade Terminal
LB-F	Lipped Blade Insulated Terminal
VT	Vinyl Sleeve
C	Cable Lugs
CL	Cable Lugs-High Voltage
CL-2D	Cable Lugs-High Voltage
BL	Cable Lugs-High Voltage
TC CTC TP	C Type Copper Compression Connectors

# Technical Data

## Cord End Terminal

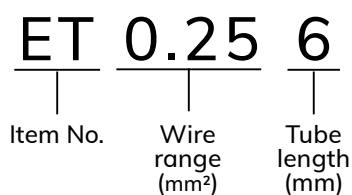

■ DIN: DIN Color, W: German Color, T: French Color

■ Color code:

- Black = **BK**   Red = **RD**   Orange = **OE**   Yellow = **YW**   Green = **GN**   Blue = **BE**
- Violet = **VT**   Grey = **GY**   White = **WE**   Brown = **BN**   Pink = **PK**   Ivory = **IY**
- Beige = **BG**   Light Blue = **LE**   Olive = **OG**   Turquoise = **TE**

Item No.	Cord		
	DIN	W	T
ET0.25-6		Light Blue ○	Violet ●
ET0.25-8		Light Blue ○	Violet ●
ET0.34-6		Turquoise ○	Pink ●
ET0.34-8		Turquoise ○	Pink ●
ET0.5-6	White ○	Orange ●	White ○
ET0.5-8	White ○	Orange ●	White ○
ET0.5-10	White ○	Orange ●	White ○
ET0.75-6	Grey ○	White ○	Blue ●
ET0.75-8	Grey ○	White ○	Blue ●
ET0.75-10	Grey ○	White ○	Blue ●
ET0.75-12	Grey ○	White ○	Blue ●
ET1.0-6	Red ●	Yellow ●	Red ●
ET1.0-8	Red ●	Yellow ●	Red ●
ET1.0-10	Red ●	Yellow ●	Red ●
ET1.0-12	Red ●	Yellow ●	Red ●
ET1.5-8	Black ●	Red ●	Black ●
ET1.5-10	Black ●	Red ●	Black ●
ET1.5-12	Black ●	Red ●	Black ●
ET1.5-18	Black ●	Red ●	Black ●
ET2.5-8	Blue ●	Blue ●	Grey ○
ET2.5-10	Blue ●	Blue ●	Grey ○
ET2.5-12	Blue ●	Blue ●	Grey ○
ET2.5-18	Blue ●	Blue ●	Grey ○

Item No.	Cord		
	DIN	W	T
ET4-10	Grey ○	Grey ○	Orange ●
ET4-12	Grey ○	Grey ○	Orange ●
ET4-18	Grey ○	Grey ○	Orange ●
ET6-12	Yellow ●	Black ●	Green ●
ET6-18	Yellow ●	Black ●	Green ●
ET10-12	Red ●	Ivory ○	Brown ●
ET10-18	Red ●	Ivory ○	Brown ●
ET16-12	Blue ●	Green ●	Ivory ○
ET16-18	Blue ●	Green ●	Ivory ○
ET25-16	Yellow ●	Brown ●	Black ●
ET25-18	Yellow ●	Brown ●	Black ●
ET25-22	Yellow ●	Brown ●	Black ●
ET35-16	Red ●	Beige ○	Red ●
ET35-18	Red ●	Beige ○	Red ●
ET35-25	Red ●	Beige ○	Red ●
ET50-20	Blue ●	Olive ●	Blue ●
ET50-25	Blue ●	Olive ●	Blue ●
ET70-21	Yellow ●		
ET95-25	Red ●		
ET120-27	Blue ●		
ET150-32	Yellow ●		

■ The above color cards are for reference only.

## Twin Cord End Terminal

Item No.	Cord		
	DIN	W	T
EW0.5-8	White ○	Orange ●	White ○
EW0.75-8	Grey ○	White ○	Blue ●
EW0.75-10	Grey ○	White ○	Blue ●
EW1.0-8	Red ●	Yellow ●	Red ●
EW1.0-10	Red ●	Yellow ●	Red ●
EW1.5-8	Black ●	Red ●	Black ●
EW1.5-12	Black ●	Red ●	Black ●

Item No.	Cord		
	DIN	W	T
EW2.5-10	Blue ●	Blue ●	Grey ○
EW2.5-13	Blue ●	Blue ●	Grey ○
EW4-12	Grey ○	Grey ○	Orange ●
EW6-14	Yellow ●	Black ●	Green ●
EW10-14	Red ●	Ivory ○	Brown ●
EW16-14	Blue ●	Green ●	Ivory ○

■ The above color cards are for reference only.

## English Fraction & Decimal - Metric Conversion Table

Fractions	Decimals	Millimeters	inch	inch	mm	inch	inch	mm
1/64	.0156250	0.397	23/64	.359375	9.128	45/64	.703125	17.859
1/32	.03125	0.794	3/8	.3750	9.525	23/32	.71875	18.256
3/64	.046875	1.191	25/64	.390625	9.922	47/64	.734375	18.653
1/16	.0625	1.588	13/32	.40625	10.319	3/4	.7500	19.050
5/64	.078125	1.984	27/64	.421875	10.716	49/64	.765625	19.447
3/32	.09375	2.381	7/16	.4375	11.113	25/32	.78125	19.844
7/64	.109375	2.778	29/64	.453125	11.509	51/64	.796875	20.241
1/8	.1250	3.175	15/32	.46875	11.906	13/16	.8125	20.638
9/64	.140625	3.572	31/64	.484375	12.303	53/64	.828125	21.034
5/32	.15625	3.969	1/2	.5000	12.700	27/32	.84375	21.431
11/64	.171875	4.366	33/64	.515625	13.097	55/64	.859375	21.828
3/16	.1875	4.763	17/32	.53125	13.494	7/8	.8750	22.225
13/64	.203125	5.159	35/64	.546875	13.891	57/64	.890625	22.622
7/32	.21875	5.556	9/16	.5625	14.288	29/32	.90625	23.019
15/64	.234375	5.953	37/64	.578125	14.684	59/64	.921875	23.416
1/4	.2500	6.350	19/32	.59375	15.081	15/16	.9375	23.813
17/64	.265625	6.747	39/64	.609375	15.478	61/64	.953125	24.209
9/32	.28125	7.144	5/8	.6250	15.875	31/32	.96875	21.606
19/64	.296875	7.541	41/64	.640625	16.272	63/64	.984375	25.003
5/16	.3125	7.938	21/32	.65625	16.669	1	1.000	25.400
21/64	.328125	8.334	43/64	.671875	17.066			
11/32	.34375	8.731	11/16	.6875	17.463			

## Cross-Reference of Wire Range

Sq (Taiwan/Japan)	AWG (America)	Drahtgrobereich mm <sup>2</sup> (England)	DIN Querschnitt mm <sup>2</sup> (Germany)
0.5	26-22	0.1-0.4	0.14/0.20/0.25/0.36
1.25	22-16	0.4-1.0	0.5/0.75/1.0
2	16-14	1.1-2.6	1.5-2.5
2	16-14HD	1.1-2.6	1.5-2.5
5.5	12-10	2.7-6.6	4-6
8	8	6.7-10.5	10
14	6	10.6-16.7	16
22	4	16.8-26.6	25
38	2	26.7-42.4	35
60	1/0	42.5-60.5	50
70	2/0	60.6-76.2	70
80	3/0	76.3-97.0	95
100	4/0	98.0-120	120
150	250-300mcm	121-151	150
180	300-350mcm	152-192	185
200	400mcm	193-242	240
325	500-600mcm	243-304	300

## Weight Chart

Kg	t	lb
1	0.001	2.20462
1000	1	2204.62
0.45359	0.0004536	1
1016.047	1.01605	2240
907.1852	0.90719	2000
0.00375	0.00000375	0.008267
0.6	0.0006	1.3228
3.75	0.00375	8.2673







	ITEM	Page	
<b>A</b>	4J/6J/8J	109	
	A	101	
	AC	177	
	AD	25	
	<b>NEW</b> AG	122	
	AG%F	126	
	AGJ	126	
	AGJL	142	
	AGJ%SR	130	
	AGJW	143	
	AGL	142	
	AG%SR	130	
	AGW	143	
	AP	109	
	ARD	43	
	ASTN	96	
	AT	93	
	ATC	110	
	AWS	222	
<b>B</b>	B-1	102	
	B2	184	
	BC	177	
	BCS	200	
	BCT	95	
	BD	23	
	BE	199	
	BG	148	
	BG%P	151	
	BGQ	150	
	<b>NEW</b> BM	149	
	BMS	202	
	BPA	142	
	<b>NEW</b> BPB	143	
	BST	95	
	BT	203	
	BWS	218	
	<b>C</b>	CAG	123
		CAP	232
CATV		112	
CB		131	
CD		43	
CDW		225	
CE		170	
CEG		125	
CE%V0		170	
CF%P		153	
<b>NEW</b> CH		106	
<b>NEW</b> CH		107	
CL		115	
<b>NEW</b> CP		153	
<b>NEW</b> CPW		153	
CR		152	
CRS		152	
CS		196	

	ITEM	Page
<b>C</b>	CS	198
	CSA	198
	<b>NEW</b> CST	116
	CTF	90
	CTT	220
	<b>NEW</b> CV	64
	<b>NEW</b> CV%CWBK	70
	CV%HS	68
	<b>NEW</b> CV%MD	67
	<b>NEW</b> CV%N46	67
	<b>NEW</b> CV%N612	68
	CV%PPBK	69
	CV%V0	69
	<b>NEW</b> CV%W	72
	<b>NEW</b> CV%XL	70
	CV%Z	66
	CV%ZW	71
	CVS	91
	CVT	64
	<b>NEW</b> CPW	153
	CW	117
CWP	106	
<b>D</b>	<b>NEW</b> DB	45
	DC	29
	DCC	114
	DCI	30
	DCP	30
	DCPT	30
	DCQ	26
	DCV	75
	DF	38
	DH	108
	DK	86
	<b>NEW</b> DKS	99
	DL	85
	DL	86
	<b>NEW</b> DLC	76
	<b>NEW</b> DMT	74
	DN	211
	DNC	193
	DNF	192
	DP	94
	<b>NEW</b> DP	95
DR	211	
DR	219	
DS	198	
DT	38	
DV	76	
<b>NEW</b> DX	46	
<b>NEW</b> DXE	46	
<b>NEW</b> DXI	46	
<b>NEW</b> DXJ	46	
<b>NEW</b> DXL	46	
<b>NEW</b> DXM	46	

	ITEM	Page
<b>D</b>	<b>NEW</b> DXO	46
	<b>E</b>	EB
EBG		156
EC		49
EC		50
ECA		49
ECB-1		50
ECP		49
ED		159
EG		124
EGHL		142
EGL		142
EG%SR		130
EGW		143
ELBF		35
<b>NEW</b> EP		175
EPA		175
ES		201
ES	217	
EX	40	
<b>F</b>	FAB	149
	FAM	149
	FAP	149
	FBG	155
	<b>NEW</b> FC	111
	<b>NEW</b> FC	112
	FC	115
	FC	116
	FCP	116
	FCT	116
	FCV	87
	FCW	116
	FD	25
	FM	50
	FMR	53
	FR	167
	<b>G</b>	GD
GE		164
GEC		164
GECQ		164
GEQ		164
GM		165
GMC		165
GMCQ		165
GMQ		165
GS		207
<b>H</b>		<b>NEW</b> HB
	<b>NEW</b> HBC	80
	<b>NEW</b> HBW	224
	<b>NEW</b> HC	105
	HD	20
	HD	25
	HGS	207
	HID	24

	ITEM	Page
<b>H</b>	HL	217
	HM	178
	HMS	202
	<b>NEW</b> HP	163
	HPA	167
	HPM	176
	HR	165
	HRCV	83
	HS	178
	HTN	205
	HTP	204
	HTS	204
	HV	81
	HV	82
	HVC	82
	HVD	21
	<b>J</b>	JD
JDE		38
JDI		38
JDL		38
JDM		38
JDO		38
JDT		38
<b>K</b>	JWB	214
	JWS	214
	K2	184
	KB	131
	KCS	205
	KD	20
	KFC	91
	KFS	91
	KG	158
	KGC	158
	KGH	158
	KG%N	158
	<b>NEW</b> KL	100
	<b>NEW</b> KS / KSP	98
	KS	99
	<b>NEW</b> KT	100
	KT-1	160
KTV	88	
KUC	104	
KVD	21	
KW	171	
KW%N	171	
KWS	214	
KWS	216	
KWS%N	216	
<b>L</b>	LCA	197
	LCH	108
	LCL	208
	LCS	208
	LD3	228
	LDC	22

	ITEM	Page
<b>L</b>	LDT	227
	LE	226
	LG	229
	LG3	228
	LH	229
	<b>NEW</b> LHC	81
	LHK	230
	<b>NEW</b> LHP	81
	<b>NEW</b> LHT	81
	<b>NEW</b> LHV	81
	LHN	229
	LK	226
	LQ	227
	LQT	227
	LS	30
	LS	31
	LWS	220
LX	227	
LY	228	
<b>M</b>	M	128
	M	129
	<b>NEW</b> M-1	102
	MAT	91
	MB	56
	MC	54
	MCR	154
	MCS	196
	<b>NEW</b> MCV	78
	MD	20
	MFC	110
	MG	154
	<b>NEW</b> MGL	92
	MGT	92
	MGTP	92
	<b>NEW</b> MH	144-145
	<b>NEW</b> MH	146
<b>NEW</b> MHF	24	
MHVC	78	
MID	24	
<b>NEW</b> MMR	203	
MMS	202	
MNC	193	
MPD	24	
MS	51	
MS	201	
MSP	164	
<b>NEW</b> MT	54	
<b>NEW</b> MTL	92	
MV	175	
MWC	117	
<b>N</b>	NBG	155
	NBGC	156
	NC	192
	<b>NEW</b> NC%N	191

	ITEM	Page		ITEM	Page		ITEM	Page		ITEM	Page				
<b>N</b>	NF	188	<b>P</b>	PDV	89	<b>R</b>	RDT	41	<b>S</b>	SM	58	<b>T</b>	TT	221	
	NF	189		PEV	90		RH	219		SN	211		TTB	222	
	NF	190		PF	233		RHR	166		SNB	102		TTU	221	
	NFD	190		PFS	109		RJ45	234		SP	197		TV	77	
	NFP	189		PFVS	90		RJ45-DC1	234		SPA	197		TV	87	
	NFR	188		PGV	90		RLC	77		SPB	197		TW	225	
	NFT	189		PH	212		RLS	198		SPC	197		TWS	218	
	NFT	190		PHC	107		RRCV	87		SPD	197		<b>U</b>	UC	104
	NFTT	190		PHV	84		RS	199		SPR	222			UD	27
	NHR2	182		PL	221		RSB	162		SPS	205			UM	57
	NHR4	182		PLD	231		RSC	212		SR	31	USB		166	
	NHS	179		PLK	230		RSD	42		SR	159	UY2	234		
	NJ	189		PLM	231		RSP	212		SR	160	<b>V</b>	V	174	
	NPT	127		PLR	232		RSTN	96		SR	161		VC	113	
	NPTA	127		PLT	232		RTF	46		SR	209		VD	21	
	NPTL	142		PLU	230		RTFI	46		SR	210		VDC	22	
	NPT%SR	130		PLW	231		RTFL	46		SRD	44	VT	174		
	NPTW	143		PLX	231		RTFM	46		SSA3	186	<b>W</b>	W3F2	185	
	NS	192		PMA	84		RTFO	46		ST	220		WA	22	
	NT	188		PMB	84		RW	225		STV	88		WB	101	
NU	191	PMT	80	RWS	219	SW%BH	170	WBS	101						
NU%N	191	PN	233	<b>S</b>	SA	183	SWC	114	WBT	101					
<b>O</b>	OC	56	PP		193	SB	162	SWD	117	WCT	89				
	OD	39	PPC		118	SBI	186	SWS	207	WD	31				
	OM	51	PR		167	SC	183	SWT-1	170	WDE	32				
	OMK	52	PRP		118	SCA	176	SWV	113	WDI	32				
	OMR	52	PRVS		90	SCM	185	SW%Y	171	WDL	32				
	OMT	53	PS		200	SCP	176	<b>T</b>	TC	36	WDM	32			
	OP	34	P-SM		57	SCS	200		TCE	37	WDO	32			
	OPC	35	PSP		164	SCT	79		TCL	37	WDT	32			
	OPE	35	PST		206	SD	25		TCL	37	WH	112			
	OPI	35	PSV	90	SD	26	TCM		37	WK32	181				
	OPL	35	PTS	110	SDB	29	TCO		37	WL	89				
	OPM	35	PUV	90	SDE	27	TCT		37	WLT	89				
	OPO	35	PVA	94	SDE	29	TCV		74	WM	55				
	OPT	35	PVF	93	SDH	28	TCVS		74	WMB	55				
	OS	34	PWS	215	SDHA	29	TD		39	WR	224				
	OSB	163	PWV	90	SDHB	29	TF	33	WS	215					
OV	39	PWVS	90	SDHF	29	TF	34	WT	21						
<b>P</b>	P	128	<b>R</b>	RBG	155	SDHI	29	TFE	32	<b>Z</b>	ZD	28			
	PA	151		RBL	41	SDHL	29	TFI	32		2 HOLES(AG/EG/AG/NPT)	132-133			
	PAO	151		RBT	41	SDHO	29	TFL	32		3 HOLES(AG/EG/AG/NPT)	134-135			
	PAQ	150		RC	114	SDHT	29	TFM	32		4 HOLES(AG/EG/AG/NPT)	136-137			
	PB	206		RCL	115	SDHV	29	TFO	32		5 HOLES(AG/EG/AG/NPT)	138-139			
	PBG	156		RCS	221	SDHX	29	TFT	32		6 HOLES(AG/EG/AG/NPT)	140			
	PB-SM	58		RCV	83	SDI	27	TG	71		7 HOLES(AG/EG/AG/NPT)	141			
	PC	104		RD	41	SDL	27	TH	223						
	PCC	218		RDA	42	SDM	27	THR	223						
	PCL	232		RDCV	75	SDO	27	TL	89						
	PCT	89		RDE	41	SDT	27	TMS	202						
	PCU	208		RDI	41	SFC	115	TR	224						
	PCV	90		RDL	41	SGN	206	TRH	223						
	PCVS	90		RDM	41	SHW	118	TRW	226						
	PD	24		RDO	41	SM	57	TS	110						



凱士士企業股份有限公司  
KAI SUH SUH ENTERPRISE CO., LTD.

---

**HEAD OFFICE:**

38, YEN PING N. RD., SEC.1 TAIPEI TAIWAN  
T: 886-2-2555-1929  
F: 886-2-2556-0052  
E: kss@mail.kss.com.tw



Whatsapp



WeChat

---

**TAINAN FACTORY:**

23, DU-CHIA, CHI-KU DIST, TAINAN TAIWAN  
T: 06-787-2239  
F: 06-787-4388  
E: kss06@mail.kss.com.tw

---

**TAICHUNG BRANCH OFFICE:**

129, KUNG YIH RD., TAICHUNG TAIWAN  
T: 04-2301-1255  
F: 04-2302-1313  
E: kss04@mail.kss.com.tw

---

**KAOHSIUNG BRANCH OFFICE:**

116, BO AI 1 RD., KAOHSIUNG TAIWAN  
T: 07-323-1488  
F: 07-323-3849  
E: kss07@mail.kss.com.tw

---

**FRANCE OFFICE**

---

**AUSTRALIA OFFICE**



[www.kss.com.tw](http://www.kss.com.tw)